

TOSHIBA BI-DIRECTIONAL TRIODE THYRISTOR SILICON PLANAR TYPE

## SM2GZ47, SM2GZ47A, SM2JZ47, SM2JZ47A

### AC POWER CONTROL APPLICATIONS

- $I_T$  (RMS) = 1A ( $T_a = 65^\circ\text{C}$  without radiator)
- Gate Trigger Current :  $I_{GT} = 5\text{mA Max. (TYPE "A")}$
- Repetitive Peak Off-State Voltage :  $V_{DRM} = 400\text{V, } 600\text{V}$
- R.M.S On-State Current :  $I_T$  (RMS) = 2A ( $T_c = 110^\circ\text{C}$ )
- Isolation Voltage :  $V_{ISOL} = 1500\text{V (AC, } t = 60\text{s)}$

### MAXIMUM RATINGS

CHARACTERISTIC	SYMBOL	RATING	UNIT
Repetitive Peak Off-State Voltage and Repetitive Peak Reverse Voltage	SM2GZ47 SM2GZ47A	400	V
	SM2JZ47 SM2JZ47A	600	
R.M.S On-State Current (Full Sine Waveform)	$T_c = 110^\circ\text{C}$	2	A
	$T_a = 65^\circ\text{C}$	1	
Peak One Cycle Surge On-State Current (Non-Repetitive)	$I_{TSM}$	8 (50Hz)	A
		8.8 (60Hz)	
$I^2t$ Limit Value	$I^2t$	0.32	$\text{A}^2\text{s}$
Peak Gate Power Dissipation	$P_{GM}$	3	W
Average Gate Power Dissipation	$P_G$ (AV)	0.3	W
Peak Gate Voltage	$V_{FGM}$	10	V
Peak Gate Current	$I_{GM}$	1.6	A
Junction Temperature	$T_j$	-40~125	$^\circ\text{C}$
Storage Temperature Range	$T_{stg}$	-40~125	$^\circ\text{C}$
Isolation Voltage (AC, $t = 1\text{min.}$ )	$V_{ISOL}$	1500	V

Unit: mm

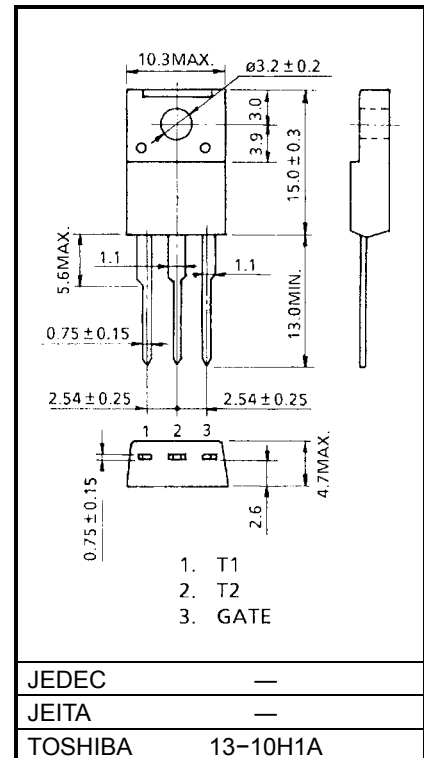

Weight: 1.7g (Typ.)

### MARKING

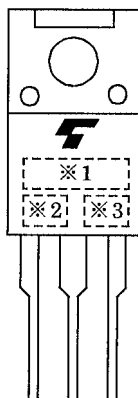

NUMBER	SYMBOL	MARK
*1	TYPE	SM2GZ47, SM2GZ47A
		SM2JZ47, SM2JZ47A
		SM2GZ47A, SM2JZ47A
*2		A
*3	Lot Number	Example 8A : January 1998 8B : February 1998 8L : December 1998
	Month (Starting from Alphabet A ) Year (Last Decimal Digit of the Current Year )	

## ELECTRICAL CHARACTERISTICS (Ta = 25°C)

CHARACTERISTIC		SYMBOL	TEST CONDITION	MIN	TYP.	MAX	UNIT		
Repetitive Peak Off-State Current		$I_{DRM}$	$V_{DRM} = \text{Rated}$	—	—	20	$\mu\text{A}$		
Gate Trigger Voltage		I II III IV	$V_{GT}$	$V_D = 12\text{V}$ $R_L = 20\Omega$	T2 (+), Gate (+)	—	—	1.5	V
					T2 (+), Gate (-)	—	—	1	
					T2 (-), Gate (-)	—	—	1	
					T2 (-), Gate (+)	—	—	—	
Gate Trigger Current	SM2GZ47 SM2JZ47	I II III IV	$I_{GT}$	$V_D = 12\text{V}$ $R_L = 20\Omega$	T2 (+), Gate (+)	—	—	8	mA
					T2 (+), Gate (-)	—	—	8	
					T2 (-), Gate (-)	—	—	8	
					T2 (-), Gate (+)	—	—	—	
	SM2GZ47A SM2JZ47A	I II III IV	$I_{GT}$	$V_D = 12\text{V}$ $R_L = 20\Omega$	T2 (+), Gate (+)	—	—	5	
					T2 (+), Gate (-)	—	—	5	
					T2 (-), Gate (-)	—	—	5	
					T2 (-), Gate (+)	—	—	—	
Peak On-State Voltage		$V_{TM}$	$I_{TM} = 3\text{A}$	—	—	1.7	V		
Gate Non-Trigger Voltage		$V_{GD}$	$V_D = \text{Rated}, T_c = 125^\circ\text{C}$	0.2	—	—	V		
Holding Current		$I_H$	$R_L = 100\Omega$	—	—	10	mA		
Thermal Resistance		$R_{th(j-a)}$	Junction to Ambient, AC	—	—	55	$^\circ\text{C} / \text{W}$		

GATE TRIGGER CHARACTERISTIC  
(SM2GZ47, SM2JZ47)

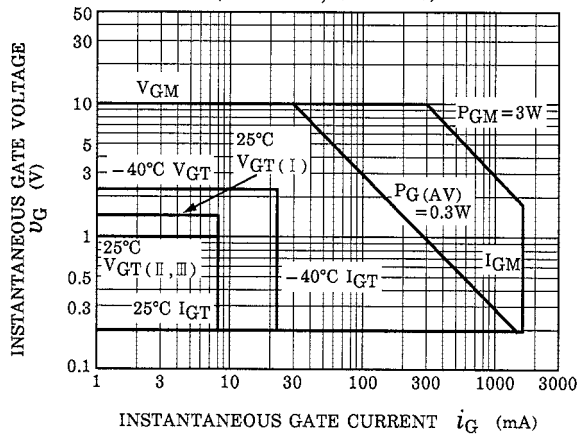

GATE TRIGGER CHARACTERISTIC  
(SM2GZ47A, SM2JZ47A)

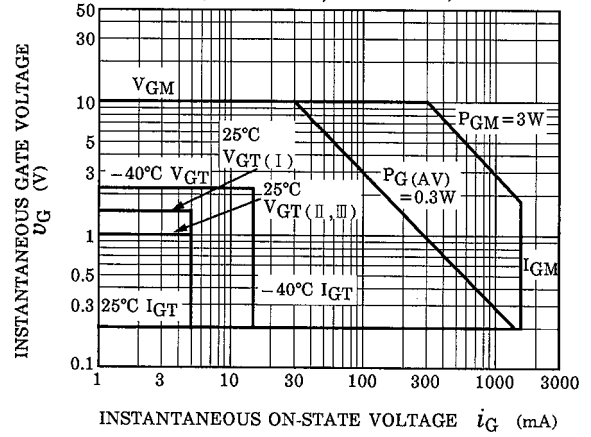

$I_{GT}(T_c) / I_{GT}(T_c = 25^\circ\text{C}) - T_c$  (TYPICAL)

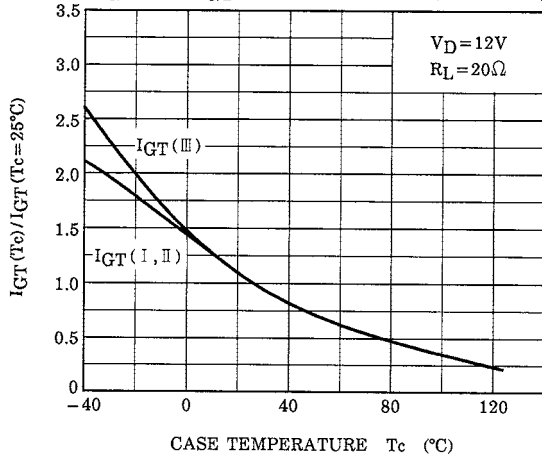

$V_{GT}(T_c) / V_{GT}(T_c = 25^\circ\text{C}) - T_c$  (TYPICAL)

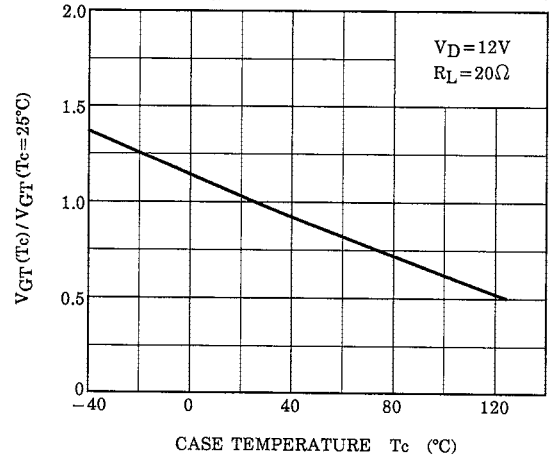

$I_H(T_c) / I_H(T_c = 25^\circ\text{C}) - T_c$  (TYPICAL)

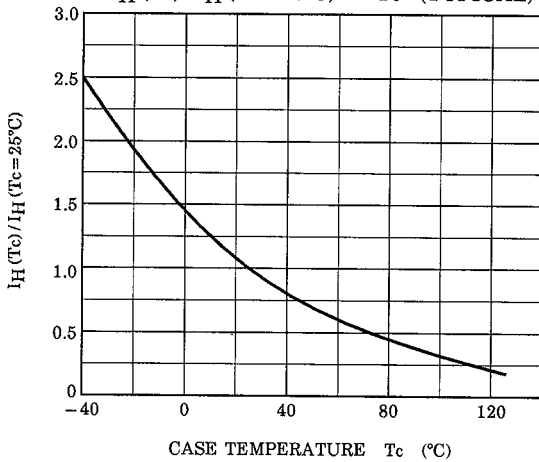

TRANSIENT THERMAL IMPEDANCE  
(JUNCTION TO AMBIENT)

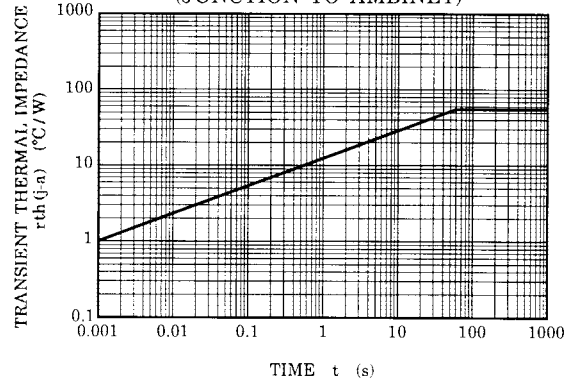

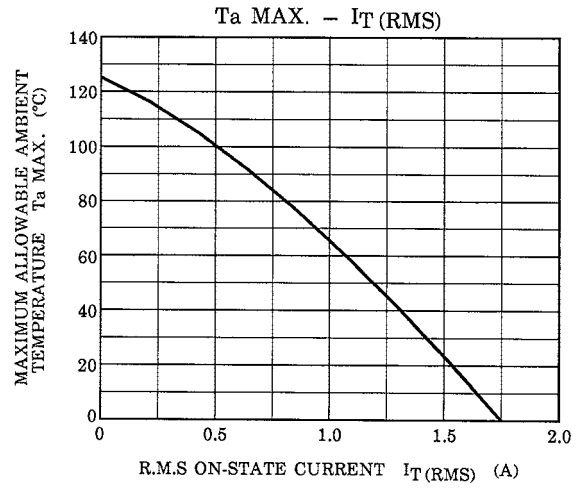
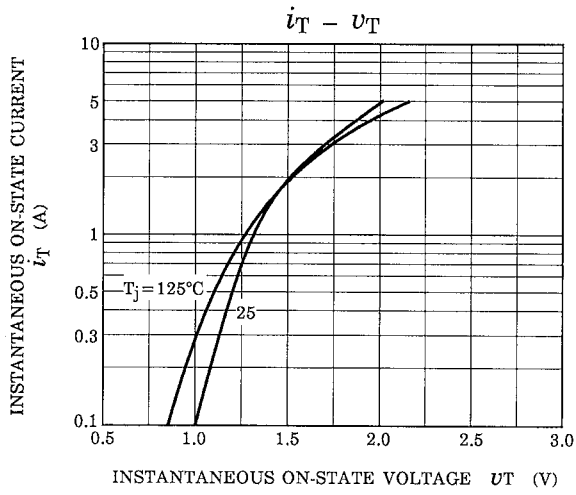

<CONDITION>

- ◆ NO HEAT SINK
- ◆ LEAD FORMING : LB182
- ◆ PRINT BOARD

(  $t = 1.6\text{mm}$   
SOLDER LAND :  $2\text{mm}\phi$  )

**RESTRICTIONS ON PRODUCT USE**

000707EAA

- TOSHIBA is continually working to improve the quality and reliability of its products. Nevertheless, semiconductor devices in general can malfunction or fail due to their inherent electrical sensitivity and vulnerability to physical stress. It is the responsibility of the buyer, when utilizing TOSHIBA products, to comply with the standards of safety in making a safe design for the entire system, and to avoid situations in which a malfunction or failure of such TOSHIBA products could cause loss of human life, bodily injury or damage to property.  
In developing your designs, please ensure that TOSHIBA products are used within specified operating ranges as set forth in the most recent TOSHIBA products specifications. Also, please keep in mind the precautions and conditions set forth in the "Handling Guide for Semiconductor Devices," or "TOSHIBA Semiconductor Reliability Handbook" etc..
- The TOSHIBA products listed in this document are intended for usage in general electronics applications (computer, personal equipment, office equipment, measuring equipment, industrial robotics, domestic appliances, etc.). These TOSHIBA products are neither intended nor warranted for usage in equipment that requires extraordinarily high quality and/or reliability or a malfunction or failure of which may cause loss of human life or bodily injury ("Unintended Usage"). Unintended Usage include atomic energy control instruments, airplane or spaceship instruments, transportation instruments, traffic signal instruments, combustion control instruments, medical instruments, all types of safety devices, etc.. Unintended Usage of TOSHIBA products listed in this document shall be made at the customer's own risk.
- The information contained herein is presented only as a guide for the applications of our products. No responsibility is assumed by TOSHIBA CORPORATION for any infringements of intellectual property or other rights of the third parties which may result from its use. No license is granted by implication or otherwise under any intellectual property or other rights of TOSHIBA CORPORATION or others.
- The information contained herein is subject to change without notice.