

SNUBBERLESS TRIACS

FEATURES

- HIGH COMMUTATION : $(di/dt)_c > 22A/ms$ without snubber
- HIGH SURGE CURRENT : $I_{TSM} = 250A$
- V_{DRM} UP TO 800V
- BTA family:
Insulated voltage = 2500V_(RMS)
(UL RECOGNIZED : E81734)

DESCRIPTION

The BTA/BTB24 BW/CW triac family are high performance glass passivated chips technology. The SNUBBERLESS™ concept offers suppression of RC network and it is suitable for application such as phase control and static switching on inductive or resistive load.

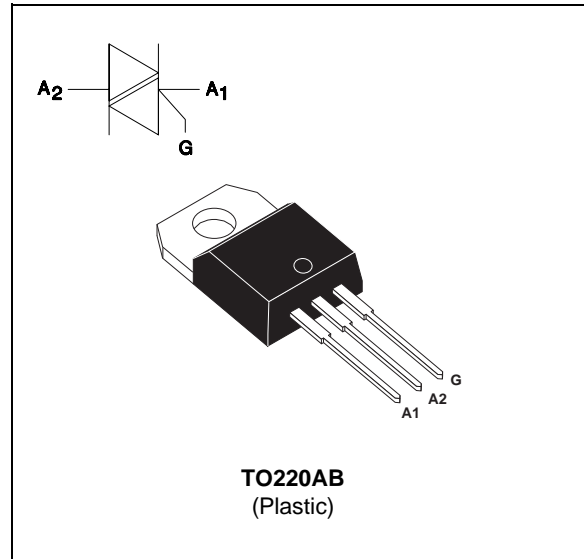

ABSOLUTE RATINGS (limiting values)

Symbol	Parameter		Value	Unit	
$I_T(RMS)$	RMS on-state current (360° conduction angle)	BTA	$T_c = 75\text{ °C}$	25	A
		BTB	$T_c = 95\text{ °C}$	25	A
I_{TSM}	Non repetitive surge peak on-state current (T_j initial = 25°C)		$t_p = 8.3\text{ ms}$	260	A
			$t_p = 10\text{ ms}$	250	
I_2t	I_2t value		$t_p = 10\text{ ms}$	312	A ² s
di/dt	Critical rate of rise of on-state current Gate supply : $I_G = 500mA$ $di_G/dt = 1A/\mu s$		Repetitive $F = 50\text{ Hz}$	20	A/ μs
			Non Repetitive	100	
T_{stg} T_j	Storage and operating junction temperature range			- 40 to + 150 - 40 to + 125	°C °C
T_I	Maximum lead temperature for soldering during 10 s at 4.5 mm from case			260	°C

Symbol	Parameter	BTA/BTB24-... BW/CW			Unit
		600	700	800	
V_{DRM} V_{RRM}	Repetitive peak off-state voltage $T_j = 125\text{ °C}$	600	700	800	V

BTA/BTB24 BW/CW

THERMAL RESISTANCES

Symbol	Parameter		Value	Unit
Rth (j-a)	Junction to ambient		60	°C/W
Rth (j-c) DC	Junction to case for DC	BTA	2.3	°C/W
		BTB	1.3	°C/W
Rth (j-c) AC	Junction to case for 360° conduction angle (F= 50 Hz)	BTA	1.7	°C/W
		BTB	1.0	°C/W

GATE CHARACTERISTICS (maximum values)

$P_G (AV) = 1W$ $P_{GM} = 10W$ (tp = 20 μs) $I_{GM} = 4A$ (tp = 20 μs).

ELECTRICAL CHARACTERISTICS

Symbol	Test Conditions	Quadrant		Suffix		Unit	
				BW	CW		
IGT	VD=12V (DC) RL=33Ω	Tj=25°C	I-II-III	MIN	4	2	mA
				MAX	50	35	
VGT	VD=12V (DC) RL=33Ω	Tj=25°C	I-II-III	MAX	1.3		V
VGD	VD=VDRM RL=3.3kΩ	Tj=125°C	I-II-III	MIN	0.2		V
IL	IG=1.2 IGT	Tj=25°C	I-III	MAX	60	50	mA
			II	MAX	120	80	
I _H *	IT= 250mA gate open	Tj=25°C		MAX	75	50	mA
V _{TM} *	ITM= 35A tp= 380μs	Tj=25°C		MAX	1.5		V
IDRM IRRM	VDRM Rated VRRM Rated	Tj=25°C		MAX	5		μA
		Tj=125°C		MAX	3		mA
dV/dt *	Linear slope up to VD=67%VDRM gate open	Tj=125°C		MIN	1000	500	V/μs
(dI/dt)c *	Without snubber	Tj=125°C		MIN	22	13	A/ms

* For either polarity of electrode A2 voltage with reference to electrode A1.

ORDERING INFORMATION

Package	IT(RMS)	VDRM / VRRM	Sensitivity Specification		
	A		V	BW	CW
BTA (Insulated)	25	600	X	X	
			700	X	X
			800	X	X
BTB (Uninsulated)	25	600	X	X	
			700	X	X
			800	X	X

Fig.1 : Maximum RMS power dissipation versus RMS on-state current.

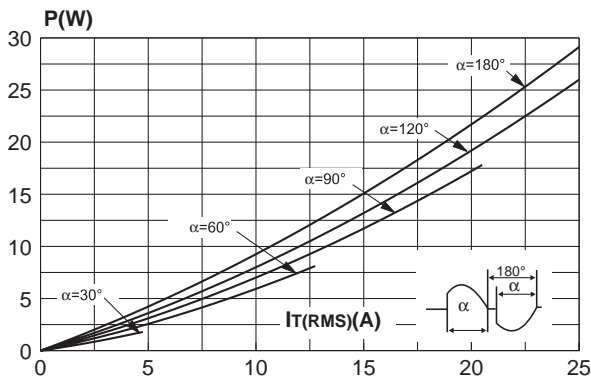

Fig.2 : Correlation between maximum power dissipation and maximum allowable temperatures (Tamb and Tcase) for different thermal resistances heatsink + contact. (BTA)

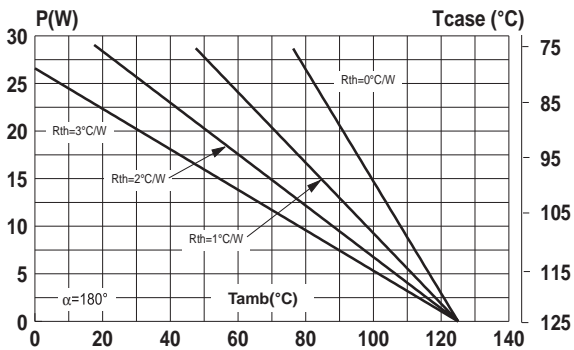

Fig.3 : Correlation between maximum power dissipation and maximum allowable temperatures (Tamb and Tcase) for different thermal resistances heatsink + contact. (BTB)

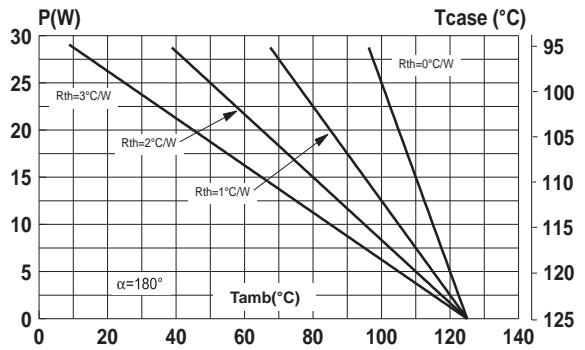

Fig.4 : RMS on-state current versus case temperature.

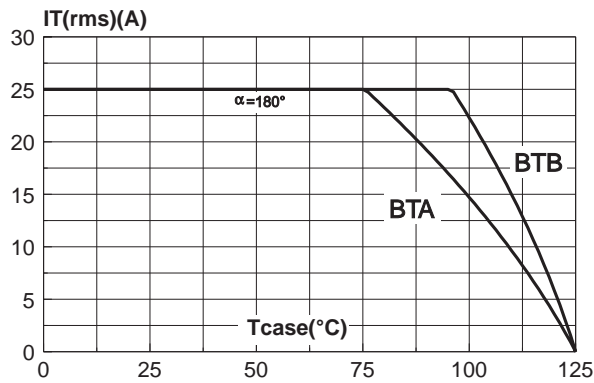

Fig.5 : Relative variation of thermal impedance versus pulse duration.

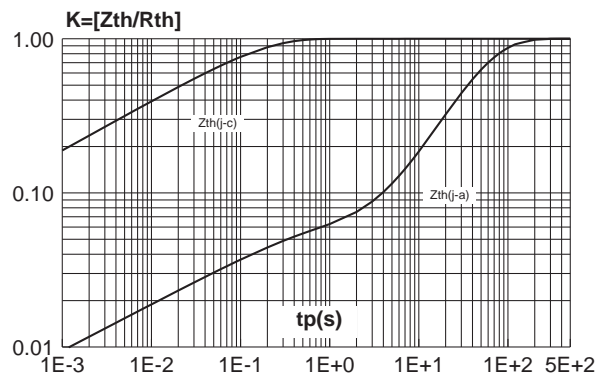

Fig.6 : Relative variation of gate trigger current and holding current versus junction temperature (typical values).

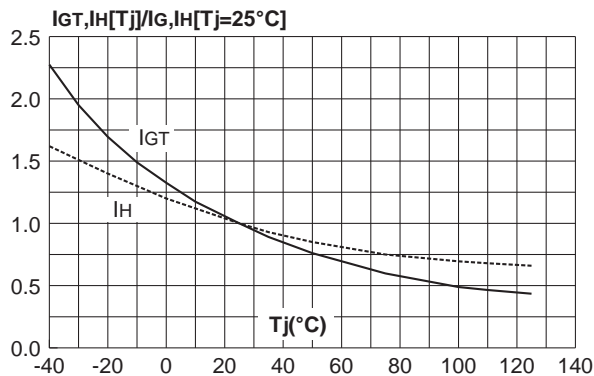

Fig.7 : Non Repetitive surge peak on-state current versus number of cycles.

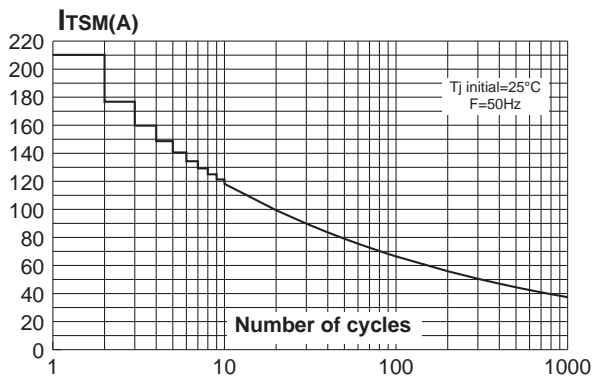

Fig.8 : Non repetitive surge peak on-state current for a sinusoidal pulse with width : $tp \leq 10ms$, and corresponding value of I^2t .

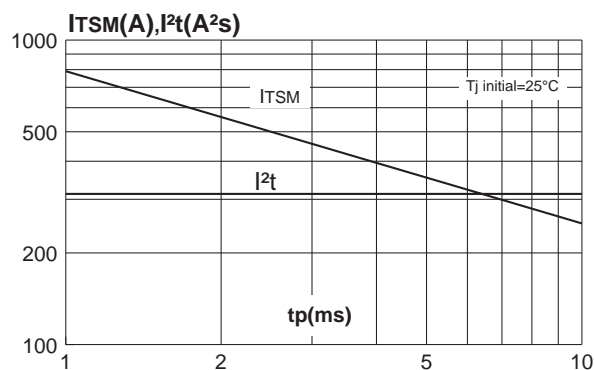
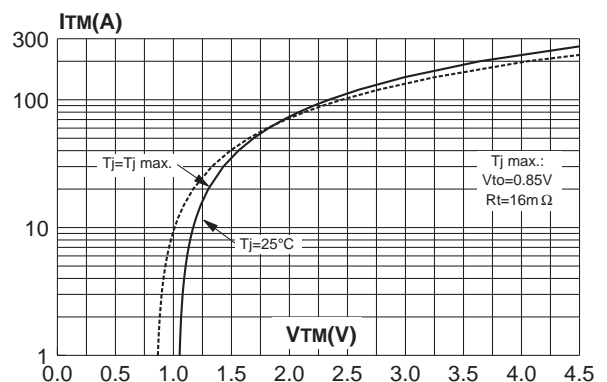
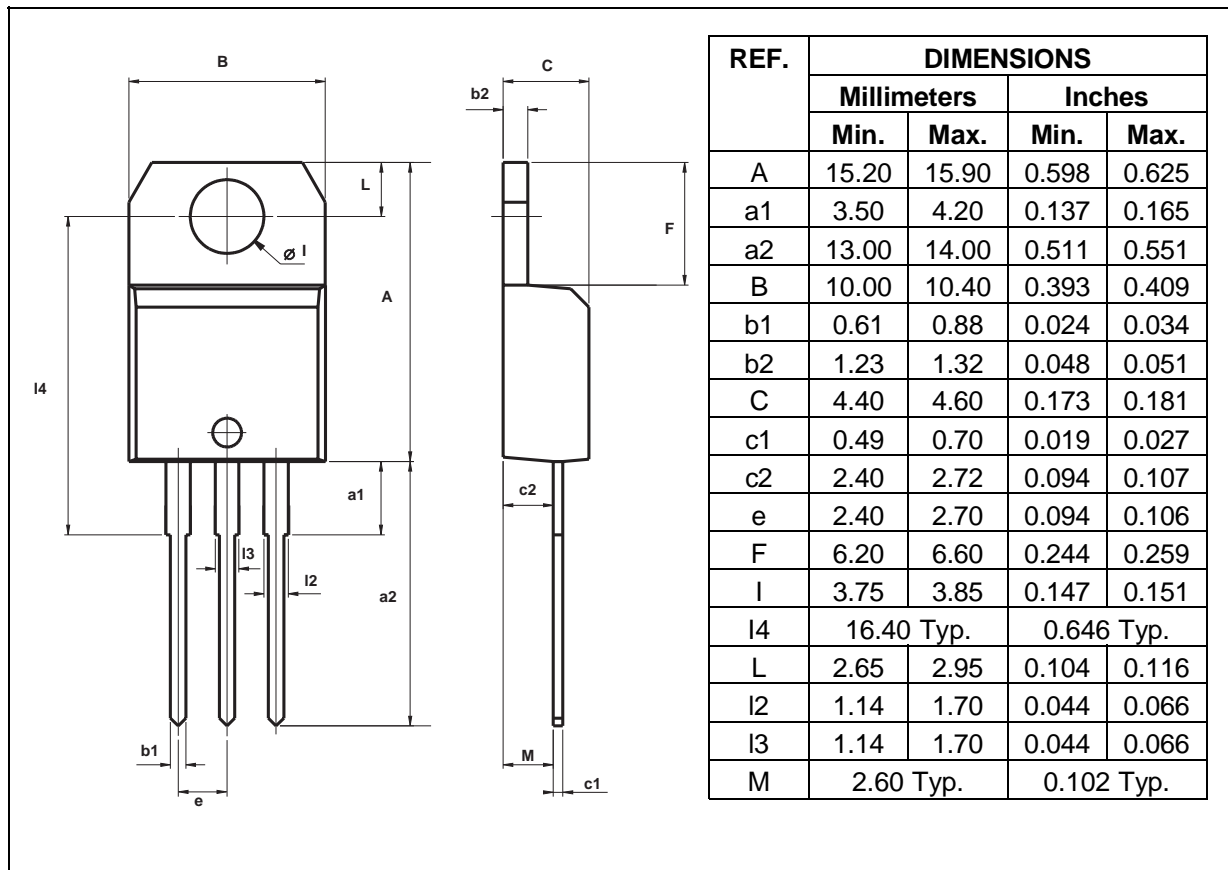

Fig.9 : On-state characteristics (maximum values).



PACKAGE MECHANICAL DATA

TO220AB Plastic



Cooling method : C
 Marking : type number
 Weight : 2.1 g
 Recommended torque value : 0.8 m.N.
 Maximum torque value : 1 m.N.

Information furnished is believed to be accurate and reliable. However, STMicroelectronics assumes no responsibility for the consequences of use of such information nor for any infringement of patents or other rights of third parties which may result from its use. No license is granted by implication or otherwise under any patent or patent rights of STMicroelectronics. Specifications mentioned in this publication are subject to change without notice. This publication supersedes and replaces all information previously supplied. STMicroelectronics products are not authorized for use as critical components in life support devices or systems without express written approval of STMicroelectronics.

The ST logo is a registered trademark of STMicroelectronics
 © 1998 STMicroelectronics - Printed in Italy - All rights reserved.

STMicroelectronics GROUP OF COMPANIES
 Australia - Brazil - Canada - China - France - Germany - Italy - Japan - Korea - Malaysia - Malta - Mexico - Morocco
 The Netherlands - Singapore - Spain - Sweden - Switzerland - Taiwan - Thailand - United Kingdom - U.S.A.

