

$V_{SM} = 2800 \text{ V}$

$I_{TAVM} = 2630 \text{ A}$

$I_{TRMS} = 4130 \text{ A}$

$I_{TSM} = 43000 \text{ A}$

$V_{T0} = 0.85 \text{ V}$

$r_T = 0.160 \text{ m}\Omega$

Bi-Directional Control Thyristor

5STB 24Q2800

Doc. No. 5SYA1053-01 Sep. 01

- Two thyristors integrated into one wafer
- Patented free-floating silicon technology
- Designed for traction, energy and industrial applications
- Optimum power handling capability
- Interdigitated amplifying gate.

The electrical and thermal data are valid for one thyristor half of the device.

Blocking

Part Number	5STB 24Q2800	5STB 24Q2600	5STB 24Q2200	Conditions
V_{SM}	3000 V	2800 V	2400 V	$f = 5 \text{ Hz}, t_p = 10\text{ms}$
V_{RM}	2800 V	2600 V	2200 V	$f = 50 \text{ Hz}, t_p = 10\text{ms}$
I_{SM}	$\leq 400 \text{ mA}$			V_{SM}
I_{RM}	$\leq 400 \text{ mA}$			V_{RM}
dV/dt_{crit}	1000 V/ μs			@ Exp. to $0.67 \times V_{SM}$
$T_j = 125^\circ\text{C}$				

V_{RM} is equal to V_{SM} up to $T_j = 110^\circ\text{C}$

Mechanical data

F_M	Mounting force	nom.	90 kN
		min.	81 kN
		max.	108 kN
a	Acceleration		
	Device unclamped		50 m/s ²
	Device clamped		100 m/s ²
m	Weight		2.1 kg
D_S	Surface creepage distance		36 mm
D_a	Air strike distance		15 mm



ABB Semiconductors AG reserves the right to change specifications without notice.



On-state

I_{TAVM}	Max. average on-state	2630 A	Half sine wave, $T_C = 70^\circ\text{C}$	
I_{TRMS}	Max. RMS on-state current	4130 A		
I_{TSM}	Max. peak non-repetitive surge current	43000 A	$t_p =$	10 ms
		46000 A	$t_p =$	8.3 ms
I^2t	Limiting load integral	9245 kA^2s	$t_p =$	10 ms
		8781 kA^2s	$t_p =$	8.3 ms
V_T	On-state voltage	1.35 V	$I_T =$	3000 A
V_{T0}	Threshold voltage	0.85 V	$I_T =$	1500 - 4500 A
r_T	Slope resistance	0.160 $\text{m}\Omega$		
I_H	Holding current	50-250 mA	$T_j = 25^\circ\text{C}$	
		25-150 mA	$T_j = 125^\circ\text{C}$	
I_L	Latching current	100-500 mA	$T_j = 25^\circ\text{C}$	
		50-300 mA	$T_j = 125^\circ\text{C}$	

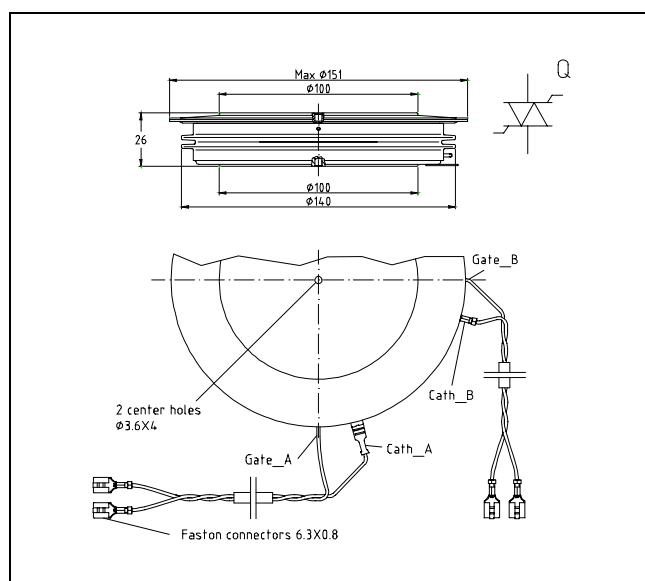
Switching

di/dt_{crit}	Critical rate of rise of on-state current	250 $\text{A}/\mu\text{s}$	Cont. $f = 50 \text{ Hz}$	$V_D \leq 0.67 \cdot V_{DRM}$, $T_j = 125^\circ\text{C}$ $I_{TRM} = 3000 \text{ A}$ $I_{FG} = 2 \text{ A}$, $t_r = 0.5 \mu\text{s}$
		500 $\text{A}/\mu\text{s}$	60 sec. $f = 50 \text{ Hz}$	
t_d	Delay time	$\leq 3.0 \mu\text{s}$	$V_D = 0.4 \cdot V_{DRM}$	$I_{FG} = 2 \text{ A}$, $t_r = 0.5 \mu\text{s}$
t_q	Turn-off time	$\leq 400 \mu\text{s}$	$V_D \leq 0.67 \cdot V_{DRM}$ $dv_D/dt = 20 \text{ V}/\mu\text{s}$	$I_{TRM} = 3000 \text{ A}$, $T_j = 125^\circ\text{C}$ $V_R > 200 \text{ V}$, $di_T/dt = -1.5 \text{ A}/\mu\text{s}$
Q_{rr}	Recovery charge	min	1100 μAs	
		max	2000 μAs	

Triggering

V_{GT}	Gate trigger voltage	$\leq 2.6 \text{ V}$	$T_j = 25^\circ\text{C}$
I_{GT}	Gate trigger current	$\leq 400 \text{ mA}$	$T_j = 25^\circ\text{C}$
V_{GD}	Gate non-trigger voltage	$\geq 0.3 \text{ V}$	$V_D = 0.4 \cdot V_{RM}$ $T_j = 125^\circ\text{C}$
I_{GD}	Gate non-trigger current	$\geq 10 \text{ mA}$	$V_D = 0.4 \cdot V_{RM}$ $T_j = 125^\circ\text{C}$
V_{FGM}	Peak forward gate voltage	12 V	
I_{FGM}	Peak forward gate current	10 A	
V_{RGM}	Peak reverse gate voltage	10 V	
P_G	Maximum gate power loss	3 W	

Thermal

T_j	Operating junction temperature range	-40...125 °C	
T_{stg}	Storage temperature range	-40...150 °C	
R_{thJC}	Thermal resistance junction to case	20 K/kW	Anode side cooled
		20 K/kW	Cathode side cooled
		10 K/kW	Double side cooled
R_{thCH}	Thermal resistance case to heat sink	4 K/kW	Single side cooled
		2 K/kW	Double side cooled

Analytical function for transient thermal impedance:

$$Z_{thJC}(t) = \sum_{i=1}^n R_i(1 - e^{-t/\tau_i})$$

i	1	2	3	4
R_i (K/kW)	6.5	1.47	1.31	0.71
τ_i (s)	0.5205	0.1075	0.0194	0.0073

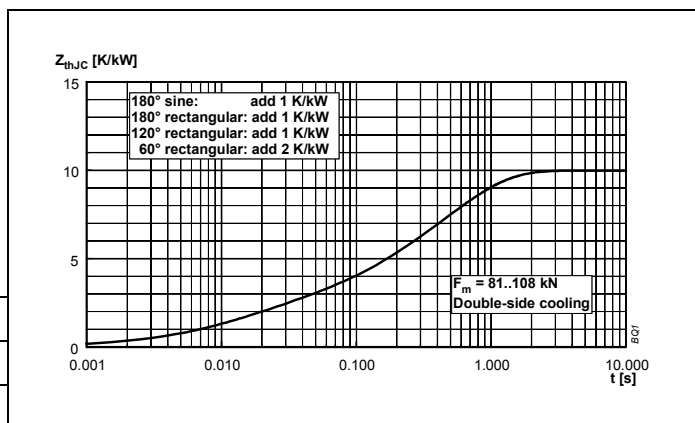

Fig. 1 Transient thermal impedance junction to case.

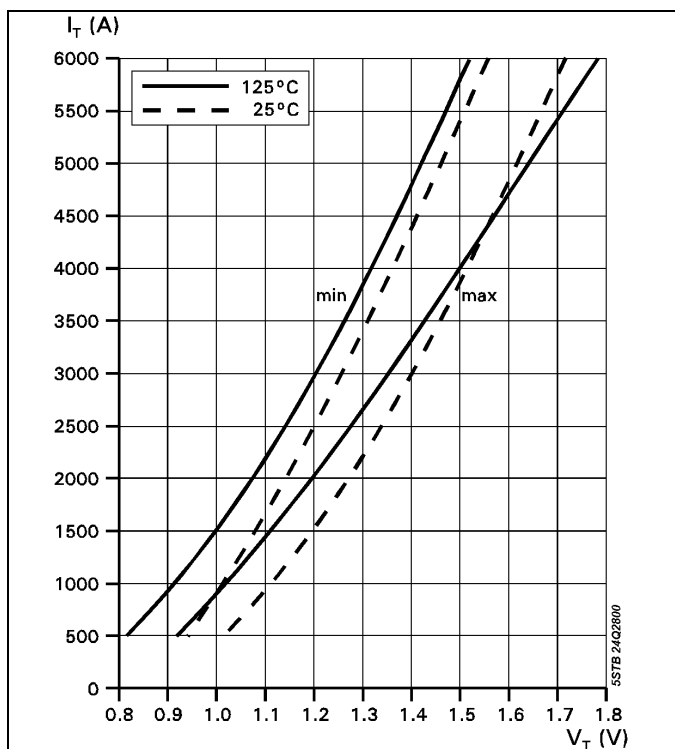

Fig. 2 On-state characteristics.

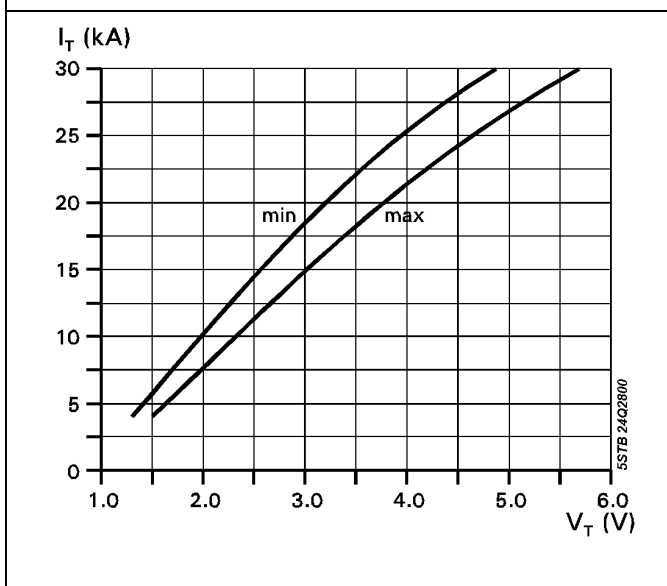

Fig. 3 On-state characteristics.

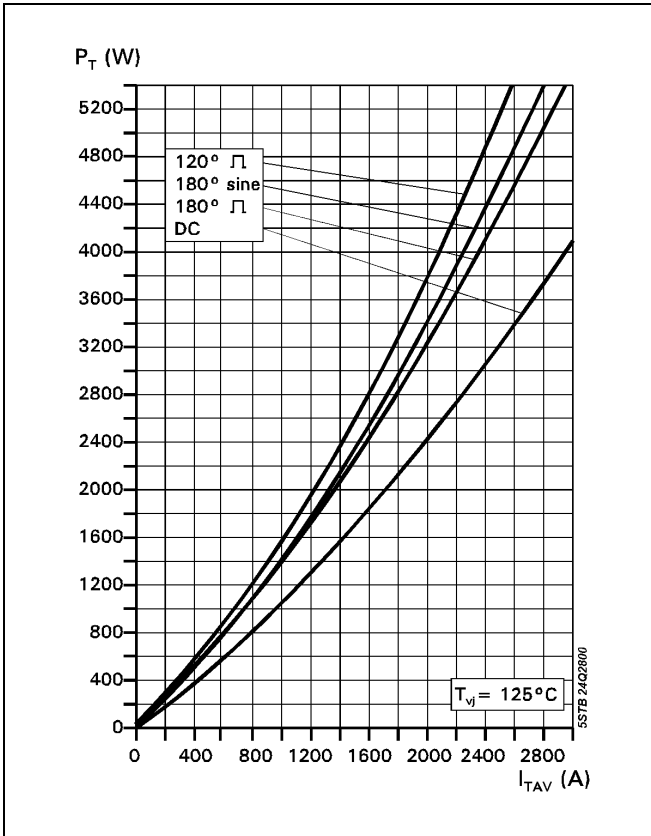

Fig. 4 On-state power dissipation vs. mean on-state current. Turn - on losses excluded.

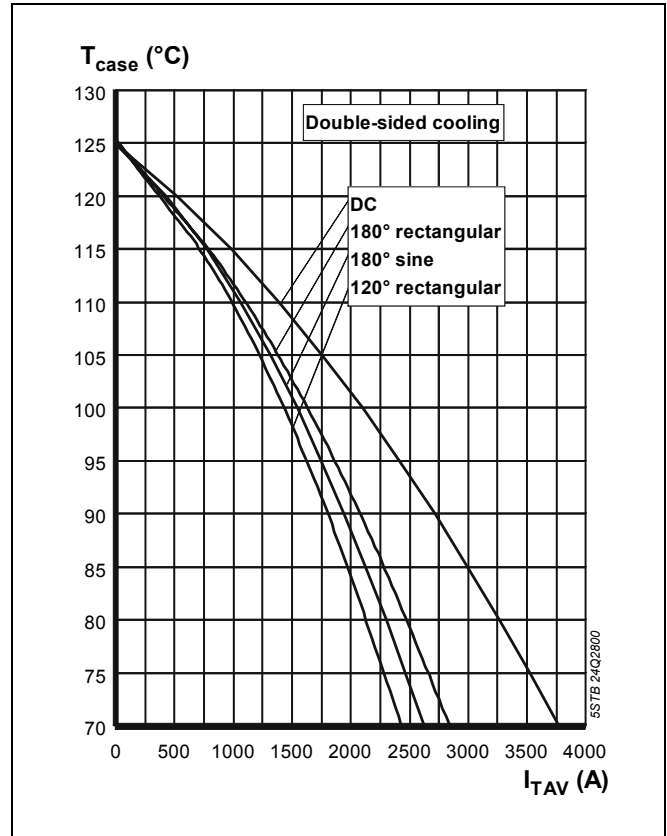

Fig. 5 Max. permissible case temperature vs. mean on-state current.

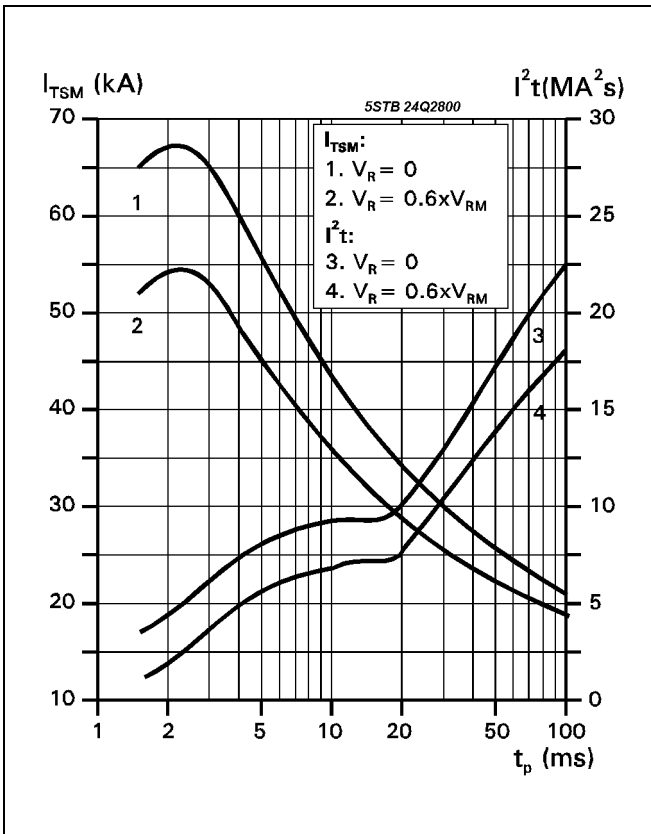

Fig. 6 Surge on-state current vs. pulse length. Half-sine wave.

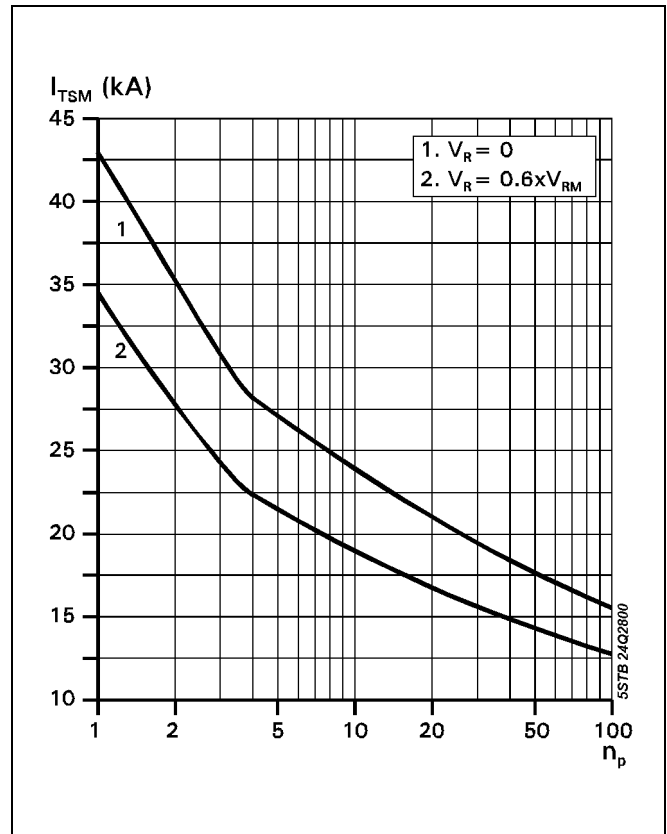

Fig. 7 Surge on-state current vs. number of pulses. Half-sine wave, 10 ms, 50Hz.

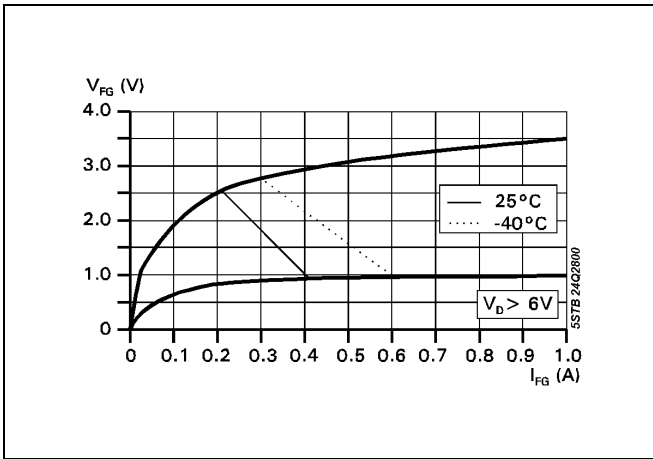

Fig. 8 Gate trigger characteristics.

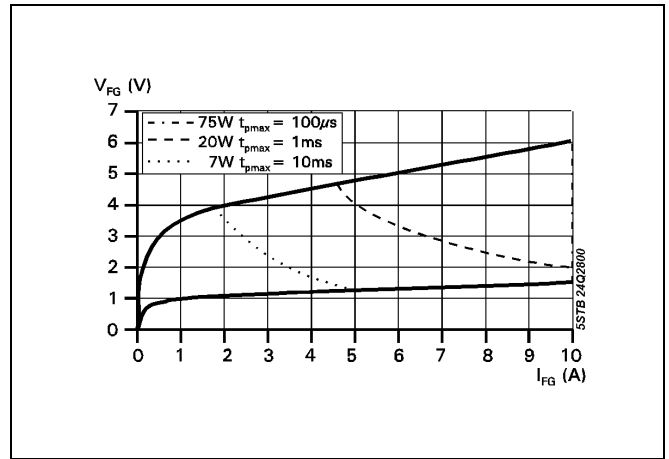

Fig. 9 Max. peak gate power loss.

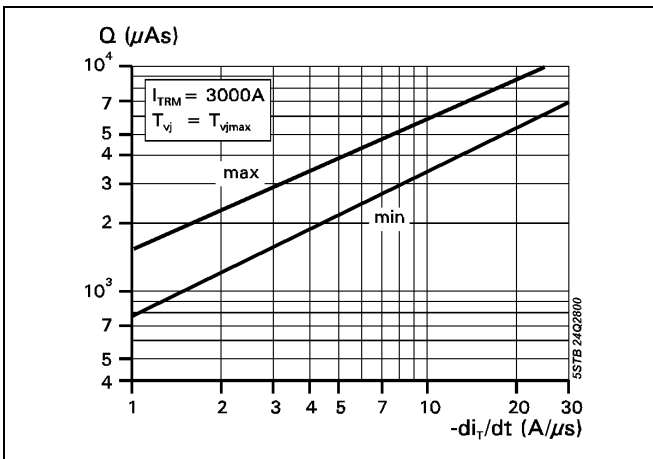

Fig. 10 Recovery charge vs. decay rate of on-state current.

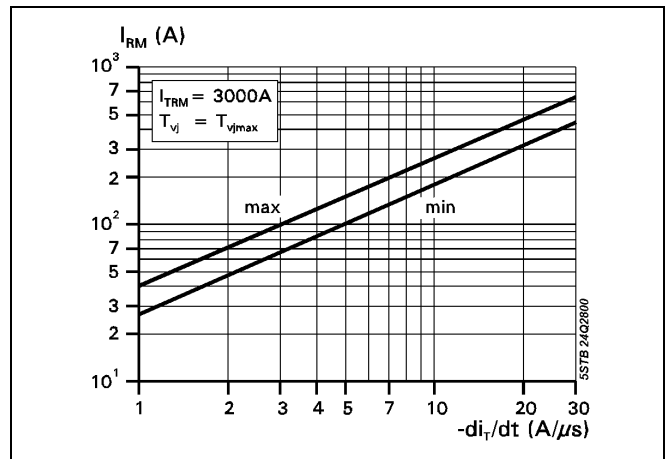

Fig. 11 Peak reverse recovery current vs. decay rate of on-state current.

ABB Semiconductors AG reserves the right to change specifications without notice.



ABB Semiconductors AG
 Fabrikstrasse 3
 CH-5600 Lenzburg, Switzerland

Telephone +41 (0)62 888 6419
 Fax +41 (0)62 888 6306
 Email abbsem@ch.abb.com
 Internet www.abbsem.com