

PT491/PT491F PT493/PT493F

■ Features

1. Epoxy resin package
2. Compact
3. Intermediate acceptance ($\Delta\theta$: TYP. $\pm 40^\circ$)
4. Long lead pin type : **PT493/PT493F**
5. Visible light cut-off type : **PT491F/PT493F**

■ Applications

1. VCRs
2. Optoelectronic switches

Intermediate Acceptance High Sensitivity Phototransistor

■ Outline Dimensions

(Unit : mm)

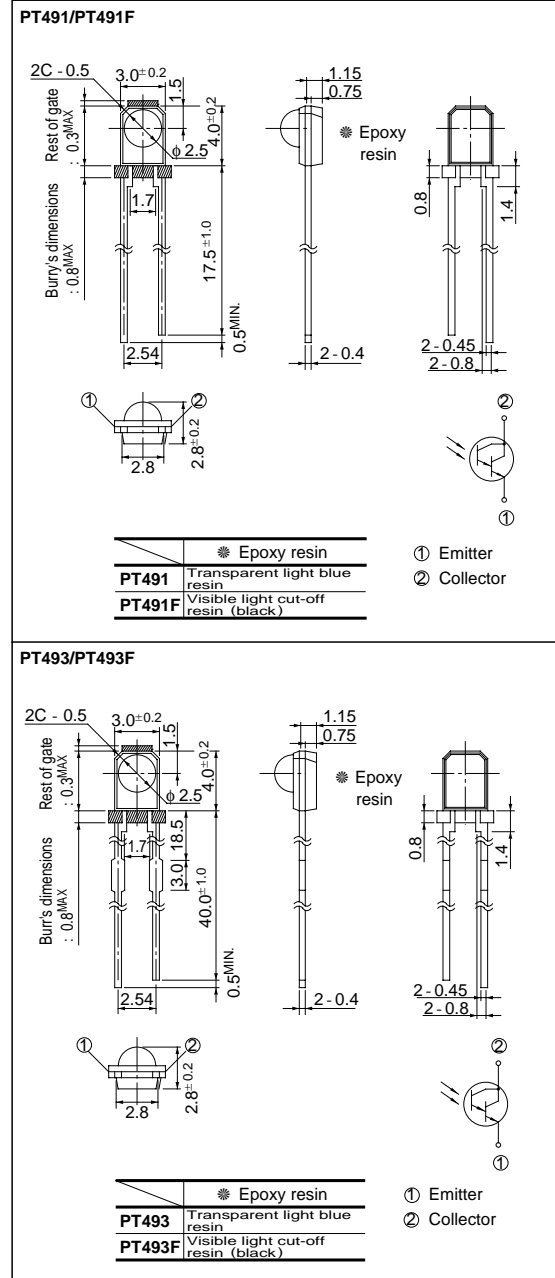

■ Absolute Maximum Ratings (Ta = 25°C)

Parameter	Symbol	Rating	Unit
Collector-emitter voltage	V_{CEO}	35	V
Emitter-collector voltage	V_{ECO}	6	V
Collector current	I_C	50	mA
Collector power dissipation	P_C	75	mW
Operating temperature	T_{opr}	-25 to +85	°C
Storage temperature	T_{stg}	-40 to +85	°C
*1 Soldering temperature	T_{sol}	260	°C

*1 For 3 seconds at the position of 1.4mm from the surface of resin edge

Electro-optical Characteristics

($T_a = 25^\circ\text{C}$)

Parameter	Symbol	Conditions	MIN.	TYP.	MAX.	Unit
*2Collector current	PT491/PT493	$V_{CE} = 2\text{V}$	0.3	0.6	1.3	mA
	PT491F/PT493F	$E_V = 21\text{x}$	0.2	0.4	0.8	mA
Collector dark current	I_{CEO}	$V_{CE} = 10\text{V}, E_e = 0$	-	-	10^{-6}	A
*2Collector-emitter saturation voltage	$V_{CE(sat)}$	$I_C = 0.8\text{mA}, E_e = 1\text{mW/cm}^2$	-	-	1.0	V
Peak sensitivity wavelength	PT491/PT493	-	-	800	-	nm
	PT491F/PT493F		-	860	-	nm
Response time	Rise time	$V_{CE} = 2\text{V}, I_C = 5\text{mA}$	-	80	400	μs
	Fall time	$R_L = 100\Omega$		70	350	
Half intensity angle	$\Delta\theta$	-	-	± 40	-	$^\circ$

*2 E_e, E_V : Illuminance, irradiance by CIE standard light source A (tungsten lamp)

Fig. 1 Collector Power Dissipation vs. Ambient Temperature

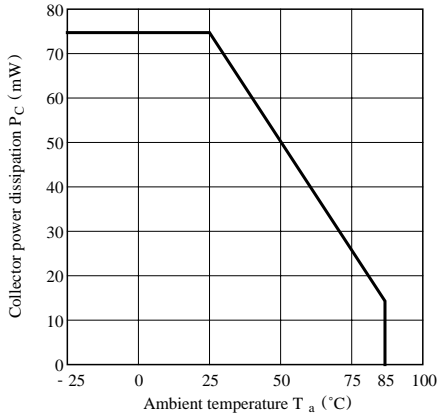

Fig. 2 Collector Dark Current vs. Ambient Temperature

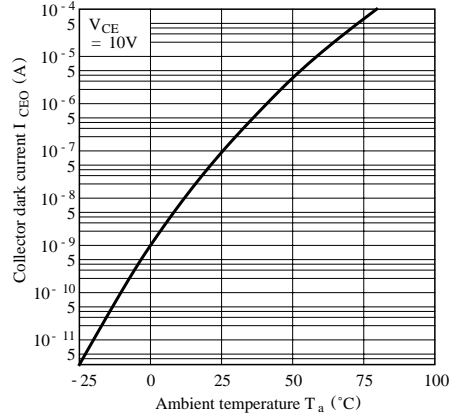

Fig. 3 Relative Collector Current vs. Ambient Temperature

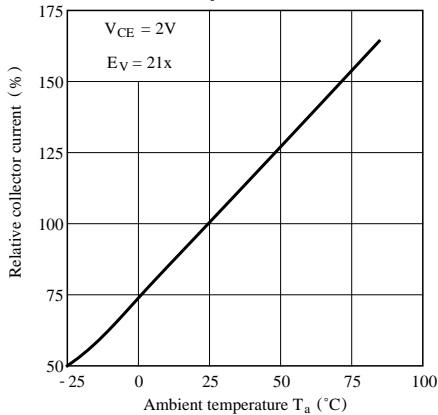

Fig. 4 Collector Current vs. Irradiance

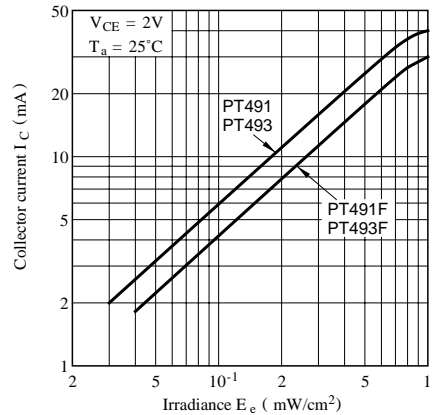

Fig. 5-a Collector Current vs. Collector-emitter Voltage (PT491/PT493)

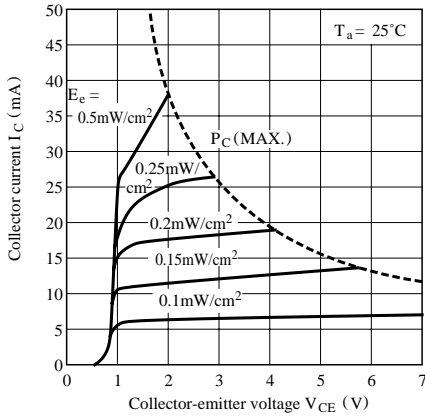

Fig. 5-b Collector Current vs. Collector-emitter Voltage (PT491F/PT493F)

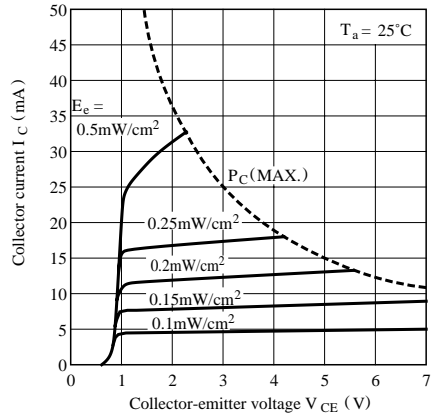

Fig. 6 Spectral Sensitivity

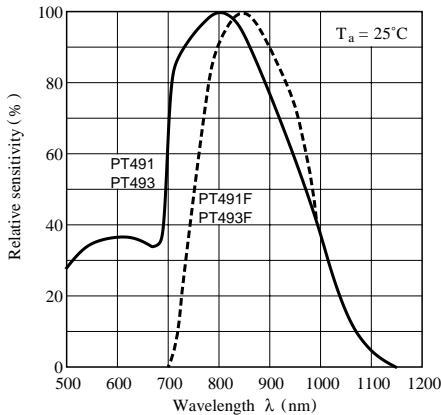
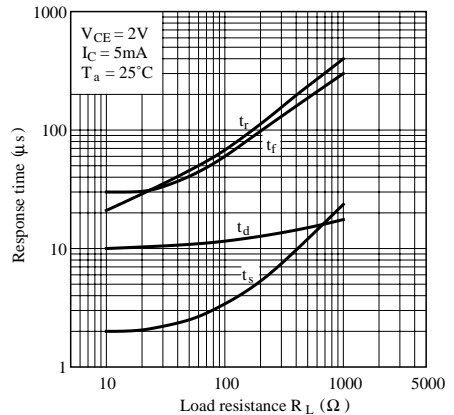

Fig. 7 Response Time vs. Load Resistance



Test Circuit for Response Time

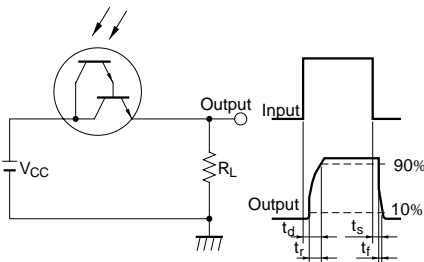

Fig. 8 Sensitivity Diagram (T_a = 25°C)

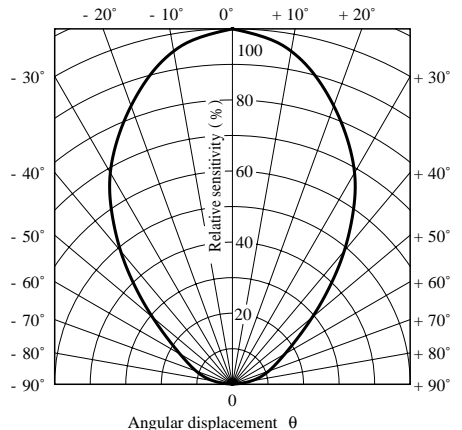

Fig. 9 Collector-emitter Saturation Voltage vs. Irradiance (PT491/PT493)

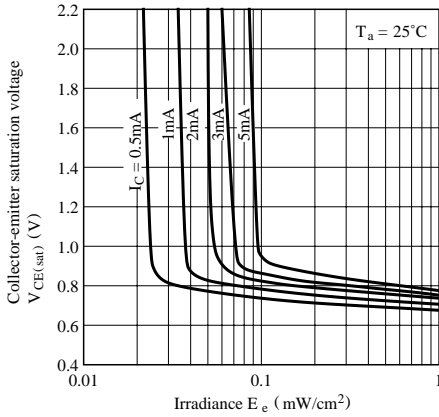
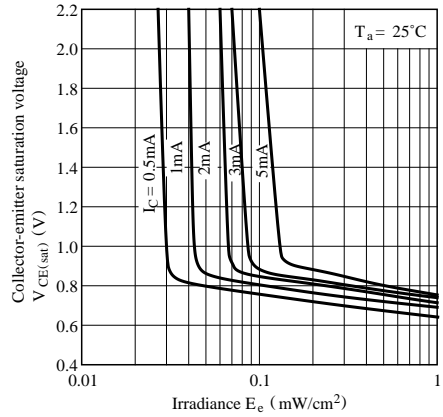

Fig.10 Collector-emitter Saturation Voltage vs. Irradiance (PT491F/PT493F)



Please refer to the chapter “Precautions for Use.”

NOTICE

- The circuit application examples in this publication are provided to explain representative applications of SHARP devices and are not intended to guarantee any circuit design or license any intellectual property rights. SHARP takes no responsibility for any problems related to any intellectual property right of a third party resulting from the use of SHARP's devices.
- Contact SHARP in order to obtain the latest device specification sheets before using any SHARP device. SHARP reserves the right to make changes in the specifications, characteristics, data, materials, structure, and other contents described herein at any time without notice in order to improve design or reliability. Manufacturing locations are also subject to change without notice.
- Observe the following points when using any devices in this publication. SHARP takes no responsibility for damage caused by improper use of the devices which does not meet the conditions and absolute maximum ratings to be used specified in the relevant specification sheet nor meet the following conditions:
 - (i) The devices in this publication are designed for use in general electronic equipment designs such as:
 - Personal computers
 - Office automation equipment
 - Telecommunication equipment [terminal]
 - Test and measurement equipment
 - Industrial control
 - Audio visual equipment
 - Consumer electronics
 - (ii) Measures such as fail-safe function and redundant design should be taken to ensure reliability and safety when SHARP devices are used for or in connection with equipment that requires higher reliability such as:
 - Transportation control and safety equipment (i.e., aircraft, trains, automobiles, etc.)
 - Traffic signals
 - Gas leakage sensor breakers
 - Alarm equipment
 - Various safety devices, etc.
 - (iii) SHARP devices shall not be used for or in connection with equipment that requires an extremely high level of reliability and safety such as:
 - Space applications
 - Telecommunication equipment [trunk lines]
 - Nuclear power control equipment
 - Medical and other life support equipment (e.g., scuba).
- Contact a SHARP representative in advance when intending to use SHARP devices for any "specific" applications other than those recommended by SHARP or when it is unclear which category mentioned above controls the intended use.
- If the SHARP devices listed in this publication fall within the scope of strategic products described in the Foreign Exchange and Foreign Trade Control Law of Japan, it is necessary to obtain approval to export such SHARP devices.
- This publication is the proprietary product of SHARP and is copyrighted, with all rights reserved. Under the copyright laws, no part of this publication may be reproduced or transmitted in any form or by any means, electronic or mechanical, for any purpose, in whole or in part, without the express written permission of SHARP. Express written permission is also required before any use of this publication may be made by a third party.
- Contact and consult with a SHARP representative if there are any questions about the contents of this publication.