

TOSHIBA Photointerrupter Infrared LED + Photo IC

# TLP1254(C6)

Photocopiers, Laser Printers and Fax Machines  
 Hot-air Heaters, Air Conditioners  
 Automatic Teller Machines  
 Arcade Game Machines

The TLP1254 (C6) is a photo-interrupter incorporating a GaAs infrared LED, an Si photo-IC and a built-in connector. This 3.3-V device is notable for its low power consumption.

The package features a new, highly reliable structure which eliminates the need to solder the device to a printed circuit board.

- Gap: 5 mm (typ.)
- Resolution: Slit width of 0.5 mm (typ.)
- Low-voltage drive, low-current consumption
  - Operating voltage: 3.3 V  $\pm$  10%
  - Supply current: 11 mA (max)
- High temperature operation: T<sub>opr</sub> = 95°C (max)
- Photo-IC output:
  - Open-collector, high-level output when no light is present
- Highly reliable package (Soldering to a PCB is unnecessary.)
- Snap-in installation
- Three board widths supported: 1.0 mm, 1.2 mm and 1.6 mm
- CT connector manufactured by Tyco Electronics AMP
- Package material:
  - Package: Polycarbonate (UL94V-2, black)
  - Connector: 66 nylon (UL94V-0, white)

Unit: mm

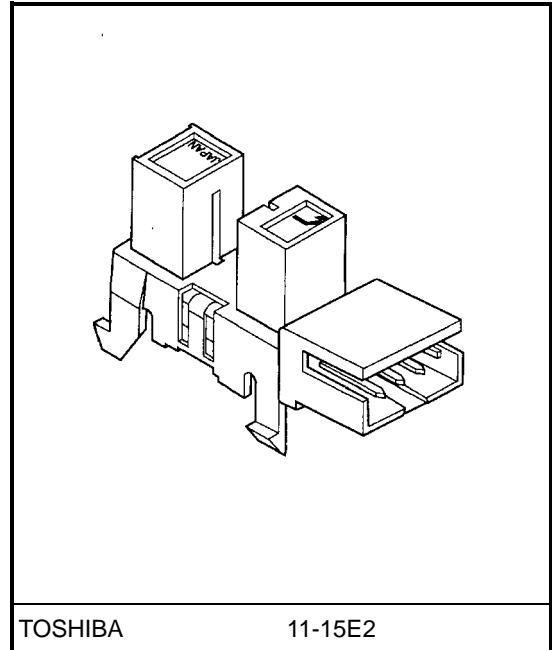

Weight: 1.3 g (typ.)

### Markings

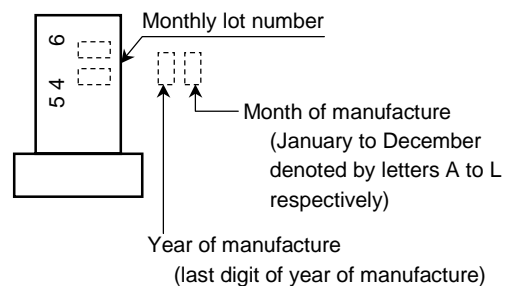

## Maximum Ratings (Ta = 25°C)

Characteristics	Symbol	Rating	Unit
Supply voltage	V <sub>CC</sub>	5	V
Output voltage	V <sub>O</sub>	15	V
Low-level output current (Ta = T <sub>opr</sub> )	I <sub>OL</sub>	8	mA
Operating temperature	T <sub>opr</sub>	-30~95	°C
Storage temperature	T <sub>stg</sub>	-40~100	°C

## Recommended Operating Conditions

Characteristics	Symbol	Min	Typ.	Max	Unit
Supply voltage	V <sub>CC</sub>	2.97	3.3	3.63	V
Output voltage	V <sub>O</sub>	—	3.3	13.2	V
Low-level output current	I <sub>OL</sub>	—	—	8	mA

## Electrical and Optical Characteristics (Ta = -30~95°C, V<sub>CC</sub> = 2.97~3.63 V)

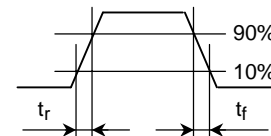
Characteristics	Symbol	Test Condition	Min	Typ.	Max	Unit
Operating supply voltage	V <sub>CC</sub>		2.97	3.3	3.63	V
High-level supply current	I <sub>CCH</sub>	When device shielded from light	—	—	11	mA
Low-level supply current	I <sub>CCL</sub>	When light enters device	—	—	11	mA
High-level output voltage	V <sub>OH</sub>	When device shielded from light, V <sub>O</sub> = 15 V, R <sub>L</sub> = 47 kΩ	0.9 V <sub>CC</sub>	—	—	V
Low-level output voltage	V <sub>OL</sub>	When light enters device, I <sub>OL</sub> = 8 mA, Ta = 25°C	—	0.04	0.35	V
		When light enters device, I <sub>OL</sub> = 8 mA	—	—	0.4	
Peak emission wavelength	λ <sub>p</sub>	Ta = 25°C, LED	—	940	—	nm
Peak sensitivity wavelength	λ <sub>p</sub>	Ta = 25°C, Photo-IC	—	900	—	nm
Response frequency	f	R <sub>L</sub> = 4.7 kΩ, Ta = 25°C, V <sub>CC</sub> = 3.3 V (Note 1)	5	—	—	kHz
Rise time	t <sub>r</sub>		—	0.5	—	μs
Fall time	t <sub>f</sub>		—	0.02	—	

Note 1: The response frequency is measured while the shutter is rotated as shown below. The output must not be DC.

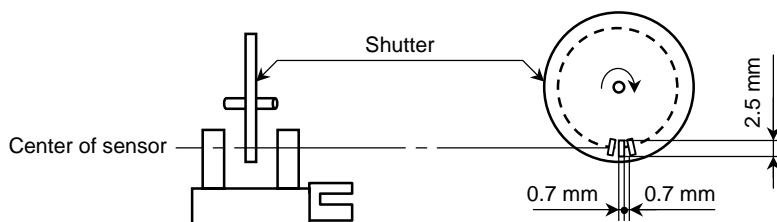

## CT Connector

### CT connector manufactured by Tyco Electronics AMP (2-mm pitch MT receptacle type)

Molded all-in-one CT connector	Model Number	Terminal Material	AWG Size	External Diameter of Insulation Coating
	173977-3	Phosphor bronze	AWG26~28	0.85~1.05 mm

### CT connector manufactured by Tyco Electronics AMP (2-mm pitch crimp receptacle type)

Model Number of Housing	179228-3				
Model Number of Terminal	Model number	Product type	Material	AWG size	External diameter of insulation coating
	179518-1	Loose	Phosphor bronze	AWG22~26	0.93~1.5 mm
	179227-1	Linked			

For more details of connector characteristics, please contact the relevant connector manufacturer.

## Precautions

- At power-on the internal circuit takes about 100 μs to stabilize. During this period the output signal is unstable and may change. Design the circuit so that no signal is output during this period.
- Keep the device away from external light. Although the photo-IC is of low optical sensitivity, the device may malfunction if external light with a wavelength of 700 nm or more is allowed to impinge on it.
- Care must be taken in relation to the environment in which the device is to be installed. Oil or chemicals may cause the package to melt or crack.
- Attach the device to a metal board at room temperature. Toshiba recommend attaching the device to the smoother side of the board. Ensure that the board is flat, and not warped or twisted.
- When attaching the device to the metal board, always hold the body of the device. Do not hold it by the connector.
- Toshiba recommend testing the attachment strength beforehand by actually attaching a device to the board.
- Do not apply solder to the pins of the device's connector. Make sure that the connector is plugged into the CT connector.
- When inserting or removing the CT connector, always grasp it and its cable firmly and either plug it straight into or pull it straight out of the device's connector. If the CT connector is inserted or removed at an angle, both the device's connector and the CT connector may get damaged, resulting in an unreliable connection.

## Package Dimensions

Unit: mm

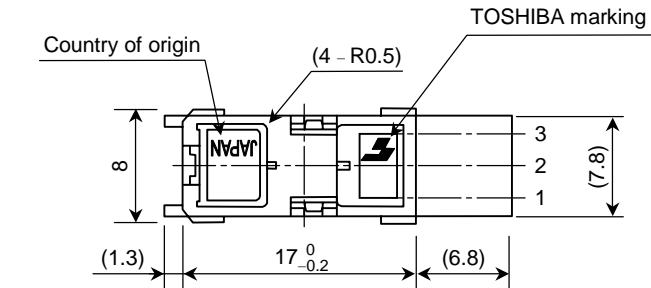

Tolerances are as listed below unless otherwise specified.

Dimension	Tolerance
6 mm or less	±0.1
Greater than 6 mm and less than or equal to 14 mm	±0.2

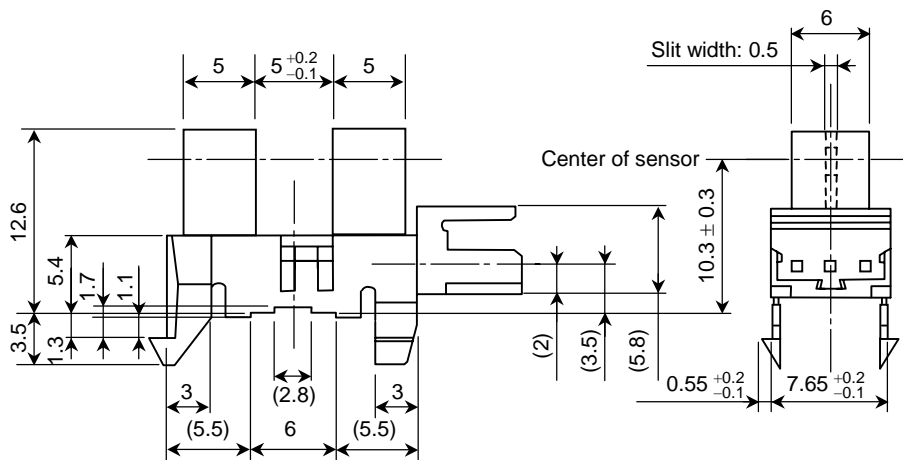

( ): reference value

Weight: 1.3 g (typ.)

## Pin Connection

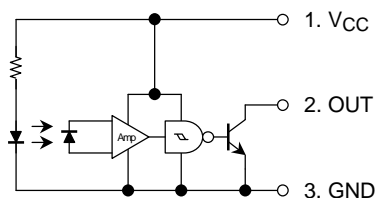

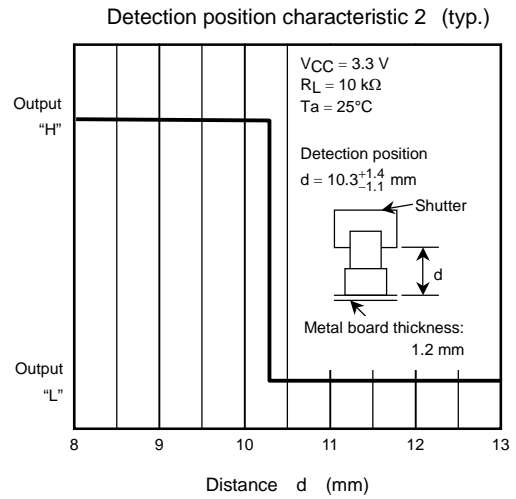
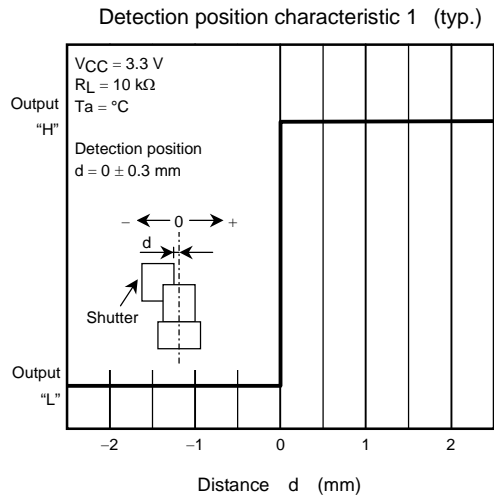
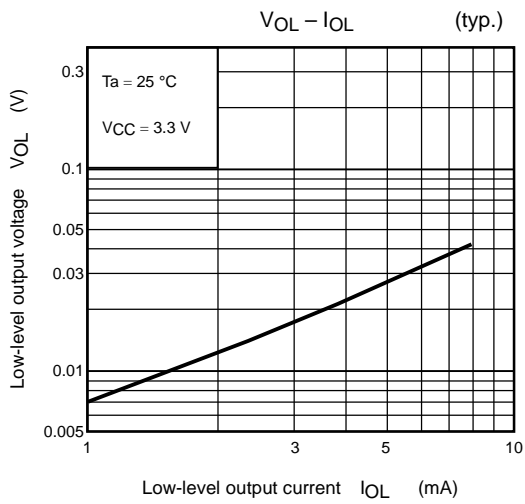

## Relative Positioning of Shutter and Device

For normal operation position the shutter and the device as shown in the figure below. By considering the device's detection direction characteristic and switching time, determine the shutter slit width and pitch.

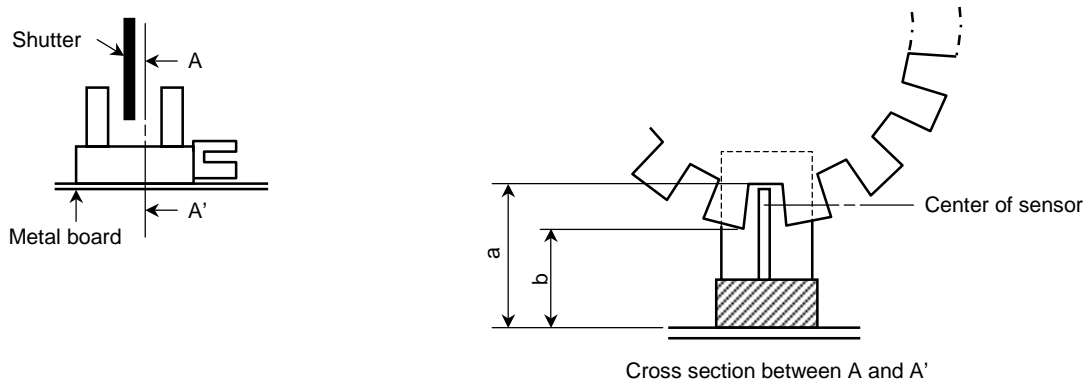

Unit: mm

Thickness of Metal Board	a Dimension	b Dimension
1.0	11.9 min	9.4 max
1.2	11.7 min	9.2 max
1.6	11.3 min	8.8 max

## Recommended Size of Connection Holes (unit: mm)

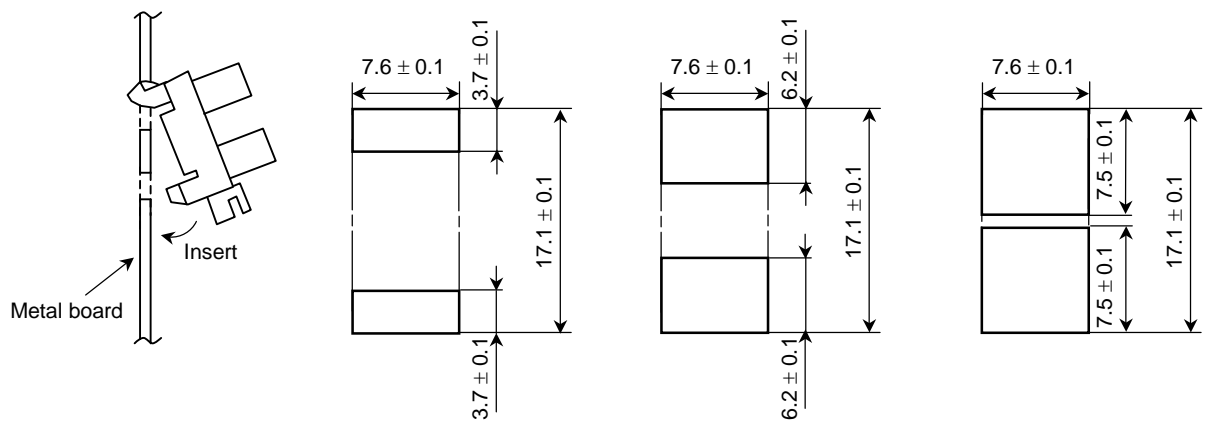

[Attachment method]

1.0-mm thick metal board

1.2-mm thick metal board

1.6-mm thick metal board

For instructions on how to attach the device to a metal board of a type other than the ones shown above, please contact your local Toshiba sales office .

**RESTRICTIONS ON PRODUCT USE**

000707EBA

- TOSHIBA is continually working to improve the quality and reliability of its products. Nevertheless, semiconductor devices in general can malfunction or fail due to their inherent electrical sensitivity and vulnerability to physical stress. It is the responsibility of the buyer, when utilizing TOSHIBA products, to comply with the standards of safety in making a safe design for the entire system, and to avoid situations in which a malfunction or failure of such TOSHIBA products could cause loss of human life, bodily injury or damage to property.  
In developing your designs, please ensure that TOSHIBA products are used within specified operating ranges as set forth in the most recent TOSHIBA products specifications. Also, please keep in mind the precautions and conditions set forth in the "Handling Guide for Semiconductor Devices," or "TOSHIBA Semiconductor Reliability Handbook" etc..
- The TOSHIBA products listed in this document are intended for usage in general electronics applications (computer, personal equipment, office equipment, measuring equipment, industrial robotics, domestic appliances, etc.). These TOSHIBA products are neither intended nor warranted for usage in equipment that requires extraordinarily high quality and/or reliability or a malfunction or failure of which may cause loss of human life or bodily injury ("Unintended Usage"). Unintended Usage include atomic energy control instruments, airplane or spaceship instruments, transportation instruments, traffic signal instruments, combustion control instruments, medical instruments, all types of safety devices, etc.. Unintended Usage of TOSHIBA products listed in this document shall be made at the customer's own risk.
- The products described in this document are subject to the foreign exchange and foreign trade laws.
- The information contained herein is presented only as a guide for the applications of our products. No responsibility is assumed by TOSHIBA CORPORATION for any infringements of intellectual property or other rights of the third parties which may result from its use. No license is granted by implication or otherwise under any intellectual property or other rights of TOSHIBA CORPORATION or others.
- The information contained herein is subject to change without notice.