

TOSHIBA PHOTO-INTERRUPTER INFRARED LED + PHOTOTRANSISTOR

TLP1241(C5)

COPIERS, PRINTERS, FAX MACHINES

FANHEATERS, AIR-CONDITIONERS

BANK ATMS

GAME MACHINES

The TLP1241 (C5) is a compact photo-interrupter which has a built-in connector and which uses a high-radiant-intensity GaAs infrared LED and an Si phototransistor. The TLP1241 (C5) is housed in a highly reliable package which eliminates the need for a printed circuit board or for soldering. It is ideal as a paper carrier location sensor for copiers and printers. The device can operate at temperatures of up to 95°C. Thus the device can be used in high-temperature applications such as a paper-out sensor or in the detection of air flow direction for air-conditioner louvers. Open-collector output can be enabled using the phototransistor.

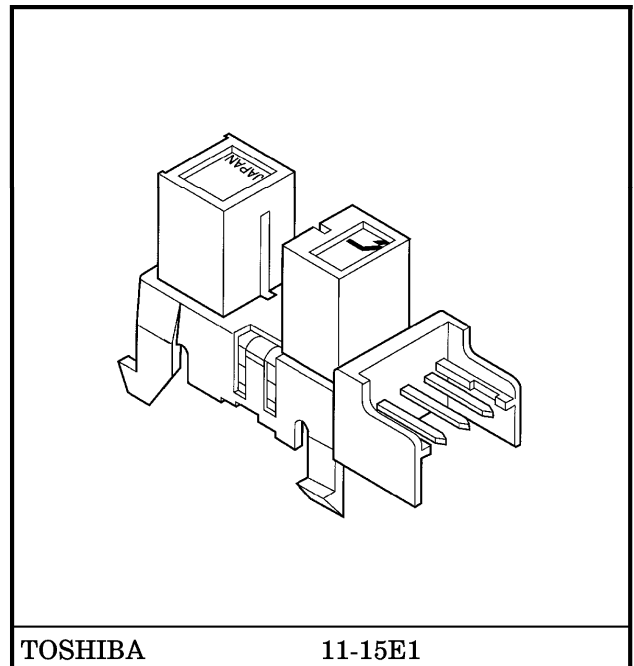

Weight : 1.4 g (typ.)

- Highly reliable package (device need not be attached to a PCB)
- Small package
- Snap-in installation
- Three board thicknesses supported : 1.0 mm, 1.2 mm and 1.6 mm
- Gap : 5 mm
- Resolution : Slit width = 0.5 mm
- High-temperature operation : $T_{opr} = 95^{\circ}\text{C}$ (max)
- High current transfer ratio : $I_C / I_F = 5\%$ (min)
- CT connector (2-mm pitch, MT receptacle type) made by Tyco Electronics AMP, Ltd.
- Package material : Polycarbonate (UL94V-2, black)
- Connector material : Polybutylene terephthalate (UL94V-0, white)

MARKING

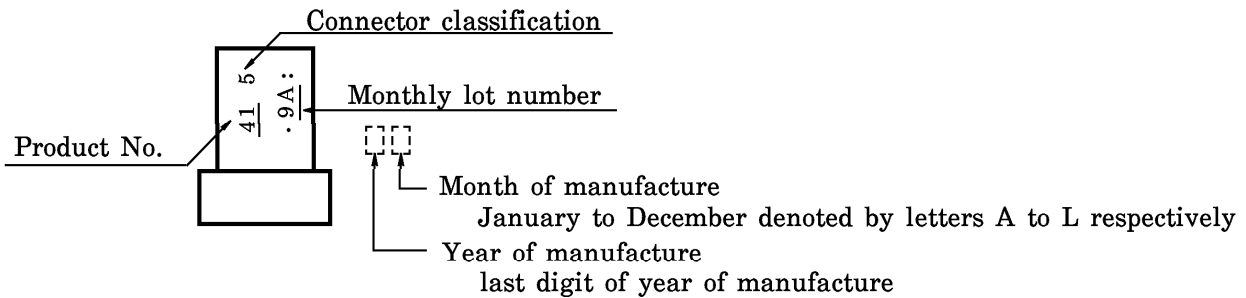

MAXIMUM RATINGS (Ta = 25°C)

CHARACTERISTIC	SYMBOL	RATING	UNIT
Forward Current	I_F	50	mA
Forward Current Derating	$\Delta I_F / ^\circ C$	(Ta > 25°C)	-0.33
		(Ta > 85°C)	-2
Reverse Voltage	V_R	6	V
Collector-Emitter Voltage	V_{CEO}	35	V
Emitter-Collector Voltage	V_{ECO}	5	V
Collector Power Dissipation	P_C	75	mW
Collector Power Dissipation Derating (Ta > 25°C)	$\Delta P_C / ^\circ C$	-1	mW / °C
Collector Current	I_C	50	mA
Operating Temperature Range	T_{opr}	-30~95	°C
Storage Temperature Range	T_{stg}	-40~100	°C

OPTICAL AND ELECTRICAL CHARACTERISTICS (Ta = 25°C)

CHARACTERISTIC	SYMBOL	TEST CONDITION	Min	Typ.	Max	UNIT	
LED	Forward Voltage	V_F	$I_F = 10 \text{ mA}$	1.00	1.15	1.30	V
	Reverse Current	I_R	$V_R = 5 \text{ V}$	—	—	10	μA
	Peak Emission Wavelength	λ_P	$I_F = 10 \text{ mA}$	—	940	—	nm
DETECTOR	Dark Current	$I_D (I_{CEO})$	$V_{CE} = 24 \text{ V}, I_F = 0$	—	0.001	0.1	μA
	Peak Sensitivity Wavelength	λ_P		—	870	—	nm
COUPLED	Current Transfer Ratio	I_C / I_F	$V_{CE} = 2 \text{ V}, I_F = 10 \text{ mA}$	5	—	100	%
	Collector-Emitter Saturation Voltage	$V_{CE}(\text{sat})$	$I_F = 20 \text{ mA}, I_C = 0.5 \text{ mA}$	—	0.1	0.35	V
	Rise Time	t_r	$V_{CC} = 5 \text{ V}, I_C = 1 \text{ mA},$	—	15	50	μs
	Fall Time	t_f	$R_L = 1 \text{ k}\Omega$	—	15	50	

PIN STRENGTH (Ta = 25°C)

CHARACTERISTIC	TEST CONDITIONS		LIMIT
Pulling	Direction	A	No defect in electrical characteristics
	Weight	19.6 N	
	Time	5 s / once	
Bending	Direction	B	
	Weight	9.8 N	
	Time	5 s / three times	

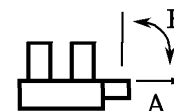

CT CONNECTOR

CT connector manufactured by Tyco Electronics AMP

Housing-Terminal En Block Type	Model Number	Terminal Material	AWG Size	External Diameter of Insulation Coating
	173977-3	Phosphor bronze	AWG26~28	0.85~1.05 mm

For more of connector characteristics, please contact the relevant connector manufacturer. Note that the device cannot be connected to a MT crimp receptacle type connector housing.

PRECAUTIONS

1. Keep the device away from external light. Although the photo-IC is of low optical sensitivity, the device may malfunction if external light with a wavelength of 700 nm or more is allowed to impinge on it.
2. Care must be taken in relation to the environment in which the device is to be installed. Oil or chemicals may cause the package to melt or crack.
3. When attaching the device to the metal board, always hold the body of the device. Do not hold it by the connector. Ensure that the board is flat, and not warped or twisted. Attach the device to a metal board at room temperature.
4. Toshiba recommend attaching the device to the smoother side of the board.
5. Toshiba recommend testing the attachment strength beforehand by actually attaching a device to the board.
6. Do not apply solder to the pins of the device's connector. Make sure that the connector is plugged into the CT connector.
7. When inserting or removing the CT connector, always grasp it and its cable firmly and either plug it straight into or pull it straight out of the device's connector. If the CT connector is inserted or removed at an angle, both the device's connector and the CT connector may get damaged, resulting in an unreliable connection.
8. Conversion efficiency falls over time due to the current which flows in the infrared LED. When designing a circuit, take into account this change in conversion efficiency over time. The ratio of fluctuation in conversion efficiency to fluctuation in infrared LED optical output is 1 : 1.

$$\frac{I_C / I_F(t)}{I_C / I_F(0)} = \frac{P_O(t)}{P_O(0)}$$

PACKAGE DIMENSIONS : TOSHIBA 11-15E1

Unit in mm

() : Reference value

Tolerance are listed below unless otherwise specified.

Dimension	Tolerance
6 mm or less	± 0.1
Greater than 6 mm and less than or equal to 14 mm	± 0.2

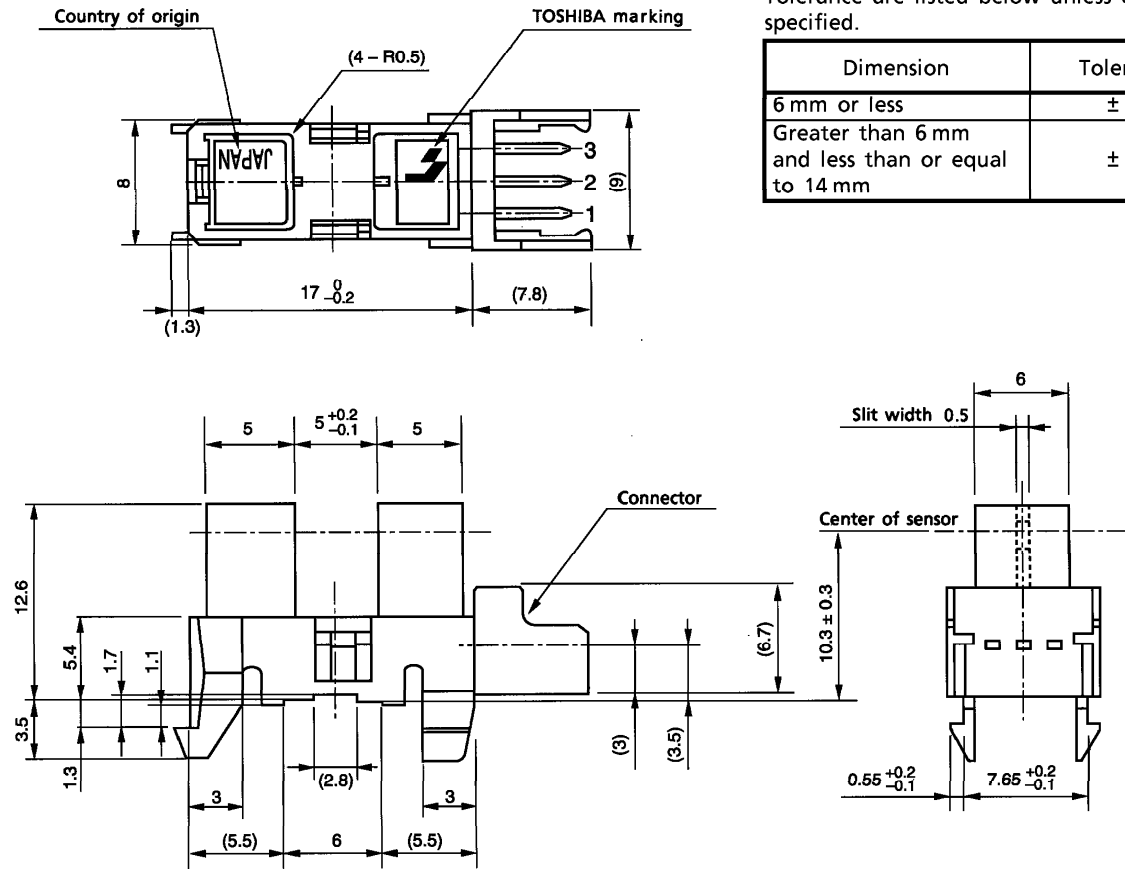

Weight : 1.4 g (typ.)

PIN CONNECTION

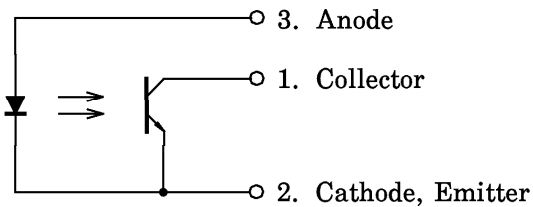

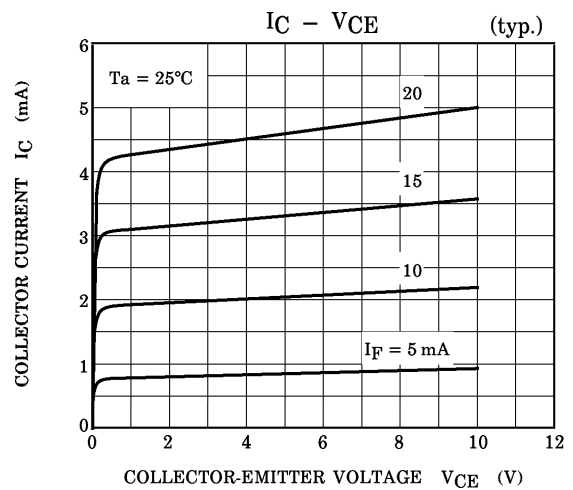
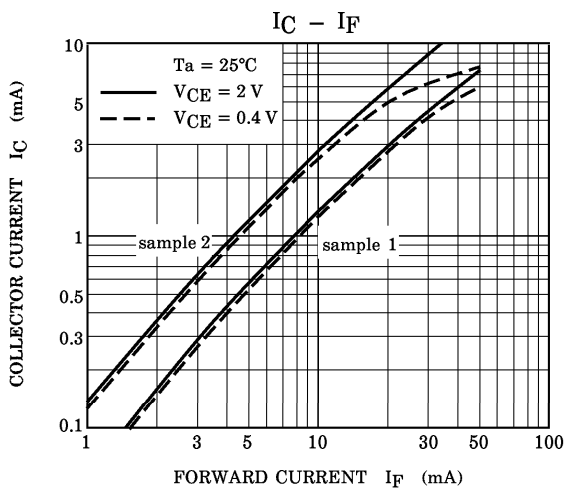
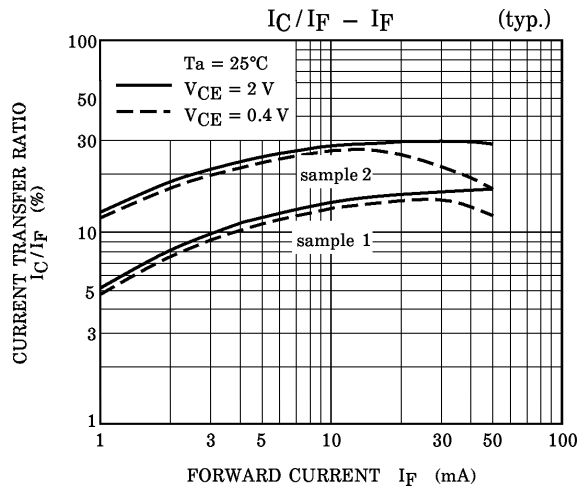
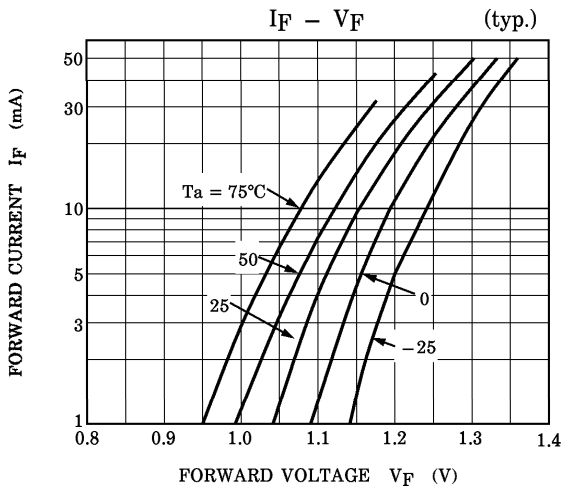
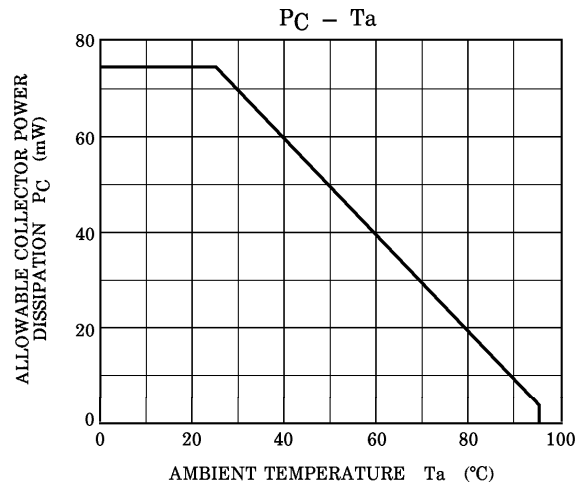
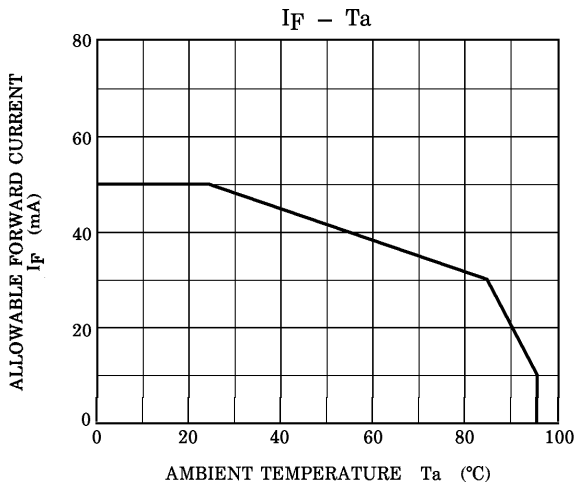

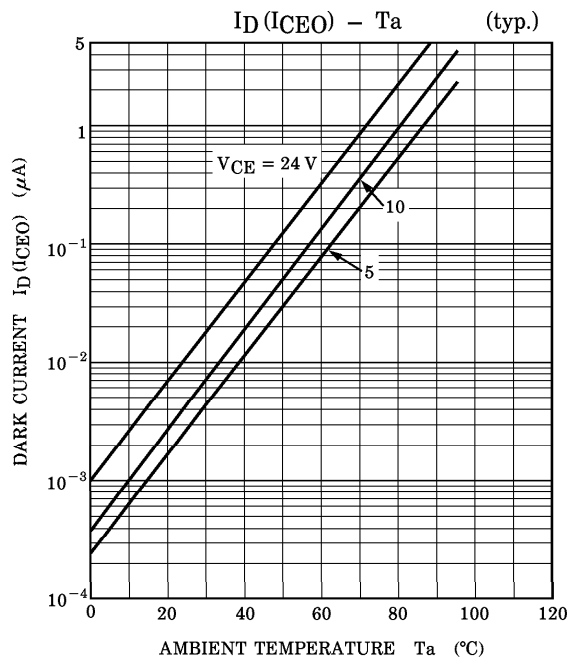
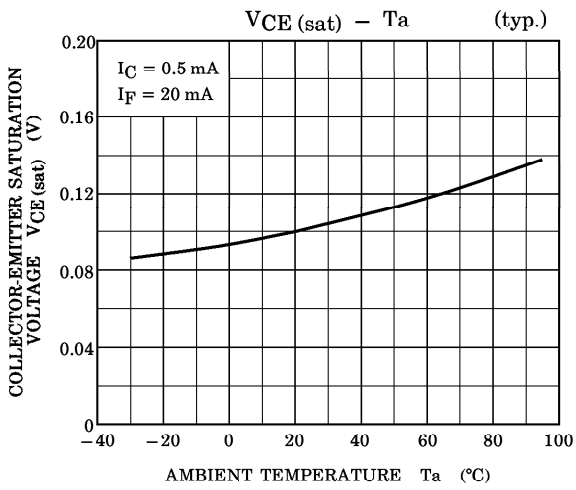
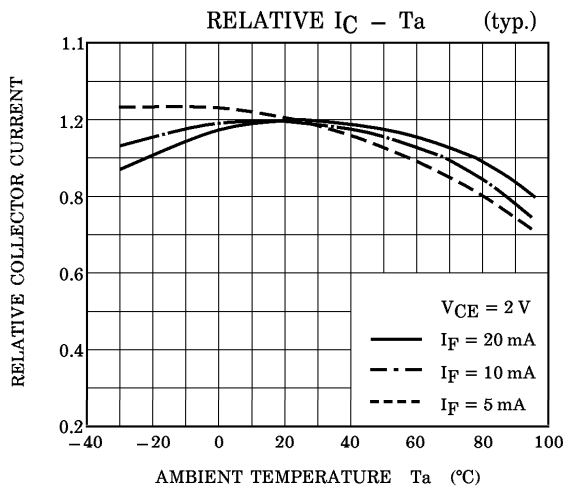

SWITCHING TIME TEST CIRCUIT

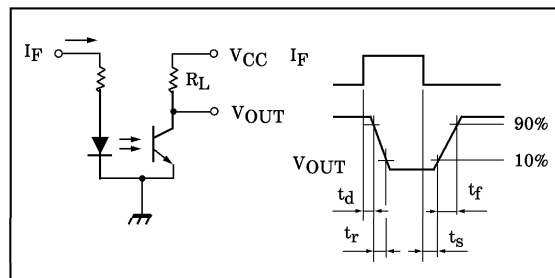

SWITCHING CHARACTERISTICS (NON SATURATED OPERATION) (typ.)

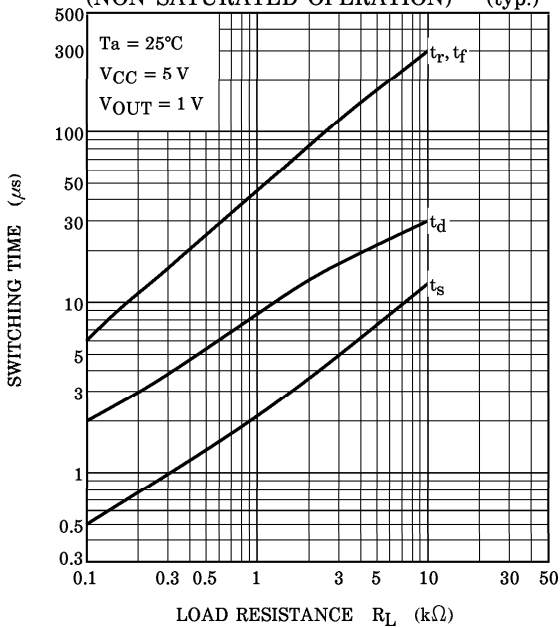

SWITCHING CHARACTERISTICS (SATURATED OPERATION) (typ.)

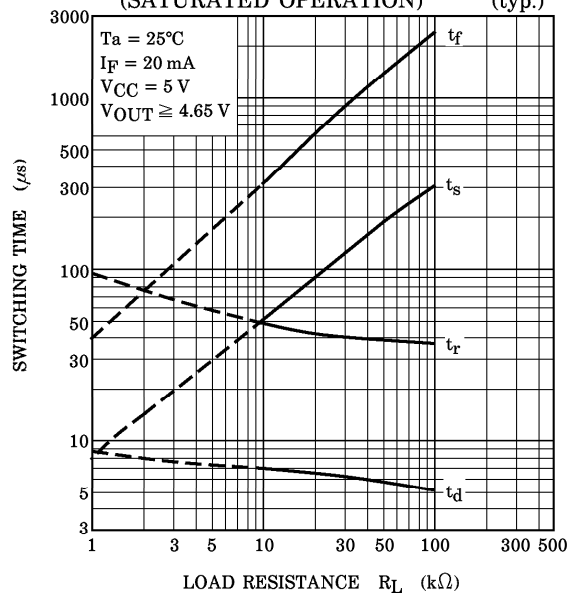

DETECTION POSITION CHARACTERISTICS (1) (typ.)

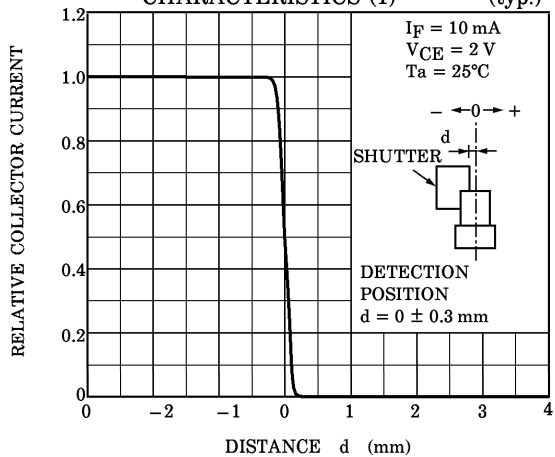

DETECTION POSITION CHARACTERISTICS (2) (typ.)

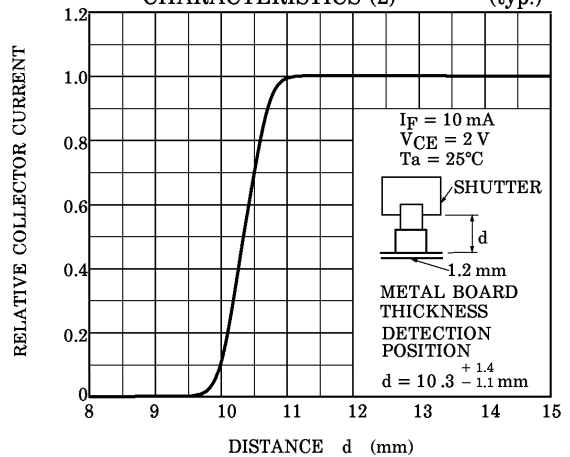

RELATIVE POSITIONING OF SHUTTER AND DEVICE

For normal operation position the shutter and the device as shown in the figure below. By considering the device's detection direction characteristic and switching time, determine the shutter slit width and pitch.

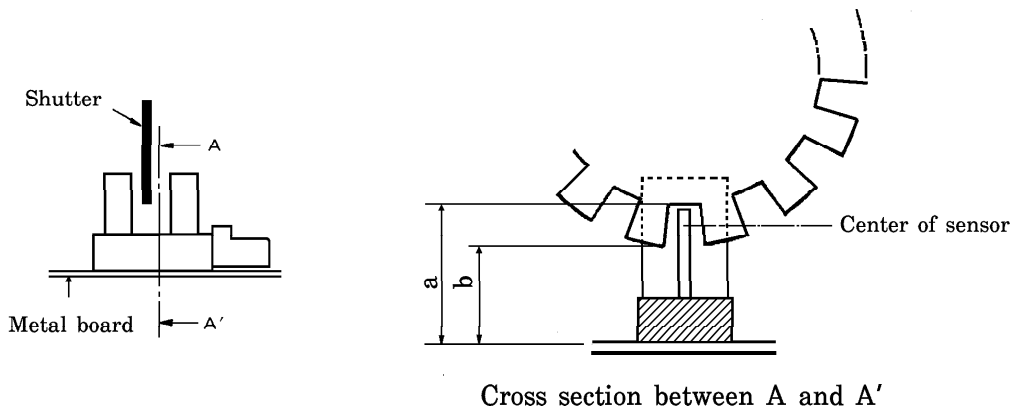

Unit : mm

Thickness of Metal Board	a Dimension	b Dimension
1.0	11.9 min	9.4 max
1.2	11.7 min	9.2 max
1.6	11.3 min	8.8 max

RECOMMENDED SIZE OF CONNECTION HOLES

(Unit : mm)

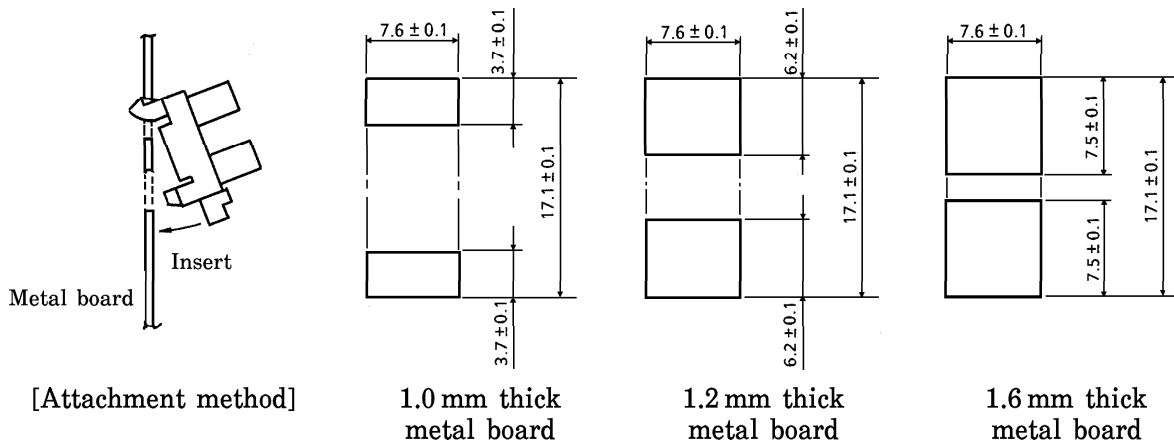

For instruction on how to attach the device to a metal board of a type other than the ones shown above, please contact your local Toshiba sales office.

RESTRICTIONS ON PRODUCT USE

000707EAC

- TOSHIBA is continually working to improve the quality and reliability of its products. Nevertheless, semiconductor devices in general can malfunction or fail due to their inherent electrical sensitivity and vulnerability to physical stress. It is the responsibility of the buyer, when utilizing TOSHIBA products, to comply with the standards of safety in making a safe design for the entire system, and to avoid situations in which a malfunction or failure of such TOSHIBA products could cause loss of human life, bodily injury or damage to property. In developing your designs, please ensure that TOSHIBA products are used within specified operating ranges as set forth in the most recent TOSHIBA products specifications. Also, please keep in mind the precautions and conditions set forth in the "Handling Guide for Semiconductor Devices," or "TOSHIBA Semiconductor Reliability Handbook" etc..
- The TOSHIBA products listed in this document are intended for usage in general electronics applications (computer, personal equipment, office equipment, measuring equipment, industrial robotics, domestic appliances, etc.). These TOSHIBA products are neither intended nor warranted for usage in equipment that requires extraordinarily high quality and/or reliability or a malfunction or failure of which may cause loss of human life or bodily injury ("Unintended Usage"). Unintended Usage include atomic energy control instruments, airplane or spaceship instruments, transportation instruments, traffic signal instruments, combustion control instruments, medical instruments, all types of safety devices, etc.. Unintended Usage of TOSHIBA products listed in this document shall be made at the customer's own risk.
- Gallium arsenide (GaAs) is a substance used in the products described in this document. GaAs dust and fumes are toxic. Do not break, cut or pulverize the product, or use chemicals to dissolve them. When disposing of the products, follow the appropriate regulations. Do not dispose of the products with other industrial waste or with domestic garbage.
- The information contained herein is presented only as a guide for the applications of our products. No responsibility is assumed by TOSHIBA CORPORATION for any infringements of intellectual property or other rights of the third parties which may result from its use. No license is granted by implication or otherwise under any intellectual property or other rights of TOSHIBA CORPORATION or others.
- The information contained herein is subject to change without notice.