

TOSHIBA PHOTOINTERRUPTER INFRARED LED + PHOTOTRANSISTOR

TLP1231(C5)

COPIER, LASER BEAM PRINTER

FACSIMILE, PRINTER, ELECTRONIC TYPEWRITER

AUTOMATIC VENDING MACHINE, TERMINAL EQUIPMENT IN BANKING FACILITIES

VARIOUS POSITION DETECTION SENSOR

The TLP1231 (C5) is a photointerrupter with a connector using an GaAs infrared LED at the emitter side and a Si photo IC at the detector side respectively. The photo transistor is turned off when a substance is detected (when the light is shield).

This product is also usable in applications requiring severe using temperature condition such as detection of paper exit on copier, etc.

- Small package
- Phototransistor output (Anode, collector common)
- Mountable by one touch (Snap-in mounting type)
- Mountable to boards in 2 kinds of thickness (1.0mm, 1.2mm)
- Gap : 5mm
- Resolution : Slit width 0.5mm
- Large operating temperature range : $T_{opr} = -25 \sim 95^{\circ}C$
- High current transfer ratio : $I_C / I_F = 5\%$ (min)
- UL recognized PWB adopted : UL94V-0
- Material of the case : Polycarbonate
- Connector : 175487-3 (AMP (Japan), Ltd. made CT connector)

Unit in mm

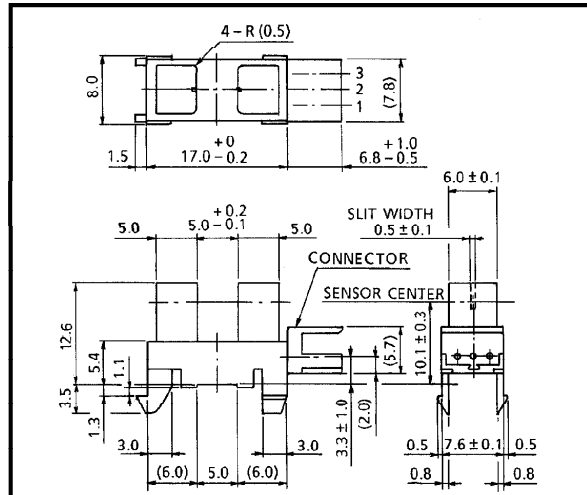

UNLESS OTHERWISE SPECIFIED

DIMENSION	TOLERANCE	() : REFERENCE VALUE
6 >	± 0.1	
6 < 14	± 0.2	

JEDEC	—
EIAJ	—
TOSHIBA	11-15C5

Weight : 1.14g (typ.)

PIN CONNECTION

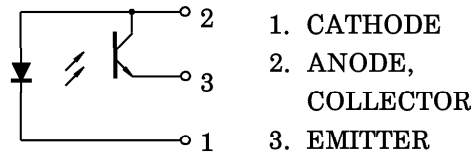

961001EBC2

● TOSHIBA is continually working to improve the quality and the reliability of its products. Nevertheless, semiconductor devices in general can malfunction or fail due to their inherent electrical sensitivity and vulnerability to physical stress. It is the responsibility of the buyer, when utilizing TOSHIBA products, to observe standards of safety, and to avoid situations in which a malfunction or failure of a TOSHIBA product could cause loss of human life, bodily injury or damage to property. In developing your designs, please ensure that TOSHIBA products are used within specified operating ranges as set forth in the most recent products specifications. Also, please keep in mind the precautions and conditions set forth in the TOSHIBA Semiconductor Reliability Handbook.

● Gallium arsenide (GaAs) is a substance used in the products described in this document. GaAs dust and fumes are toxic. Do not break, cut or pulverize the product, or use chemicals to dissolve them. When disposing of the products, follow the appropriate regulations. Do not dispose of the products with other industrial waste or with domestic garbage.

● The products described in this document are subject to foreign exchange and foreign trade control laws.

● The information contained herein is presented only as a guide for the applications of our products. No responsibility is assumed by TOSHIBA CORPORATION for any infringements of intellectual property or other rights of the third parties which may result from its use. No license is granted by implication or otherwise under any intellectual property or other rights of TOSHIBA CORPORATION or others.

● The information contained herein is subject to change without notice.

PRODUCT INDICATION

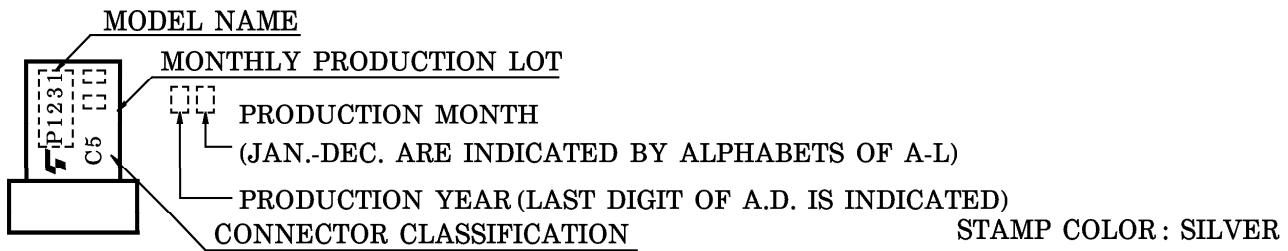

MAXIMUM RATINGS (Ta = 25°C)

CHARACTERISTIC	SYMBOL	RATING	UNIT
Forward Current	I _F	50	mA
Forward Current Derating	ΔI _F /°C	Ta > 25°C	-0.33
		Tc > 85°C	-2
Reverse Voltage	V _R	5	V
Collector-Emitter Voltage	V _{CEO}	35	V
Emitter-Collector Voltage	V _{ECO}	5	V
Collector Power Dissipation	P _C	75	mW
Collector Power Dissipation Derating (Ta > 25°C)	ΔP _C /°C	-1	mW/°C
Collector Current	I _C	50	mA
Operating Temperature Range	T _{opr}	-25~95	°C
Storage Temperature Range	T _{stg}	-40~100	°C

OPTO-ELECTRICAL CHARACTERISTICS (Ta = 25°C)

CHARACTERISTIC	SYMBOL	TEST CONDITION	MIN.	TYP.	MAX.	UNIT	
LED	Forward Voltage	V _F	I _F = 10mA	1.00	1.15	1.30	V
	Reverse Current	I _R	V _R = 5V	—	—	10	μA
	Peak Emission Wavelength	λ _P	I _F = 20mA	—	940	—	nm
DETECTOR	Dark Current	I _D	V _{CE} = 24V, I _F = 0	—	—	0.1	μA
	Peak Sensitivity Wavelength	λ _P	—	—	870	—	nm
COUPLED	Current Transfer Ratio	I _C / I _F	V _{CE} = 5V, I _F = 20mA	5	—	100	%
	Collector-Emitter Saturation Voltage	V _{CE} (sat)	I _F = 20mA, I _C = 0.5mA	—	0.15	0.4	V
	Rise Time	t _r	V _{CC} = 5V, I _C = 2mA R _L = 100Ω	—	6	—	μs
	Fall Time	t _f		—	6	—	

TERMINAL STRENGTH (Ta = 25°C)

CHARACTERISTIC	TEST CONDITION		LIMIT
PULL	DIRECTION	A	NO DEFECT OF ELECTRICAL CHARACTERISTICS
	WEIGHT	19.6N	
	TIME	5s / ONCE	
BEND	DIRECTION	B	
	WEIGHT	9.8N	
	TIME	5s / THRICE	

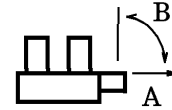

RECOMMENDABLE MATCHED CONNECTOR

AMP (Japan), Ltd. made CT connector

HOUSING-TERMINAL EN BLOCK TYPE	TYPE No.	TERMINAL MATERIAL	AWG SIZE	INSULATION DIAMETER
	173977-3	PHOSPHOR BRONZE	AWG 26~28	0.85~1.05mm

For details of the connectors, please refer to the connector maker.

PRECAUTION

Please be careful of the followings.

1. When installing, avoid to work by holding the connector by hand. Always, install by holding the main body of the element while assuring the mounting board is not warped or twisted. The connectors shall be inserted or pulled out at normal temperature.
2. It is recommended to mount this product by inserting from the sheet metal pressed side.
3. The container is made of polycarbonate. Polycarbonate is usually stable with acid, alcohol, and aliphatic hydrocarbons however, with peroxochemicals (such as benzene, toluene, and acetone), alkali, aromatic hydrocarbons, or chloric hydrocarbons, polycarbonate becomes cracked, swollen, or melted. Please take care when choosing a packaging material by referencing the table below.

<Chemicals to avoid with polycarbonate>

	PHENOMENON	CHEMICALS
A	Little deterioration but staining	<ul style="list-style-type: none"> • nitric acid (low concentration), hydrogen peroxide, chlorine
B	Cracked, crazed, or swollen	<ul style="list-style-type: none"> • acetic acid (70% or more) • gasoline • methyl ethyl ketone, ethyl acetate, butyl acetate • ethyl methacrylate, ethyl ether, MEK • acetone, m-amino alcohol, carbon tetrachloride • carbon disulfide, trichloroethylene, cresol • thinners, oil of turpentine • triethanolamine, TCP, TBP
C	Melted { } : Used as solvent.	<ul style="list-style-type: none"> • concentrated sulfuric acid • benzene • styrene, acrylonitrile, vinyl acetate • ethylenediamine, diethylenediamine • {chloroform, methyl chloride, tetrachloromethane, dioxane, } • {1, 2-dichloroethane }
D	Decomposed	<ul style="list-style-type: none"> • ammonia water • other alkali

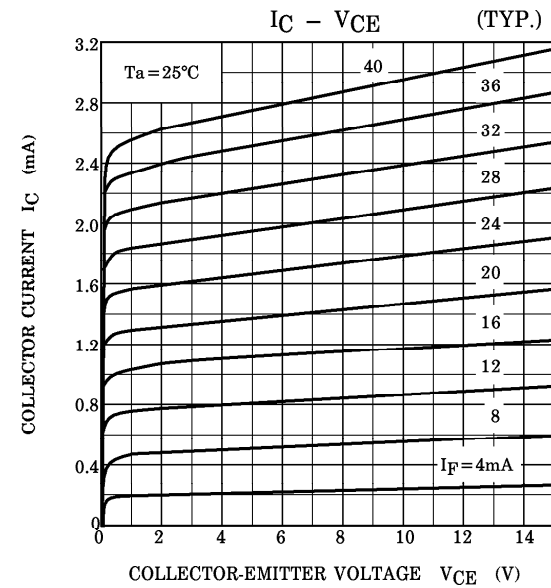
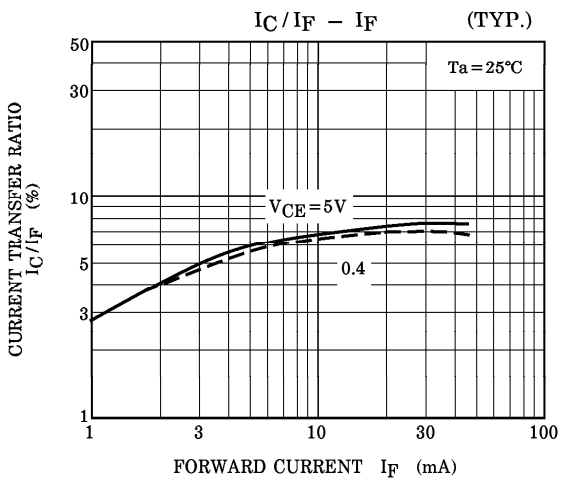
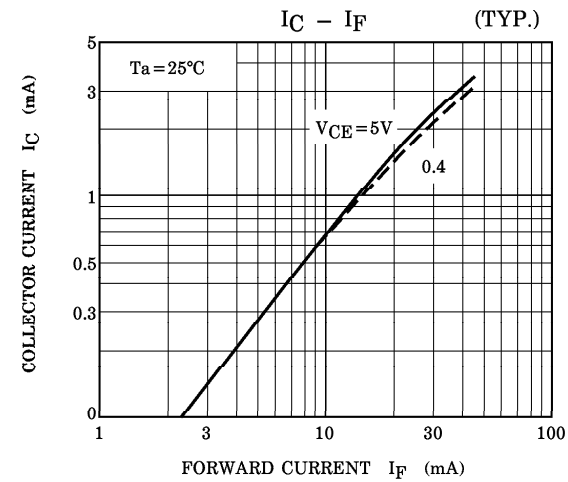
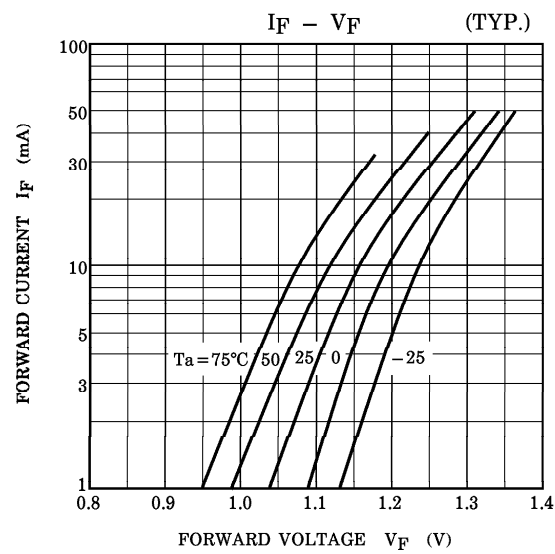
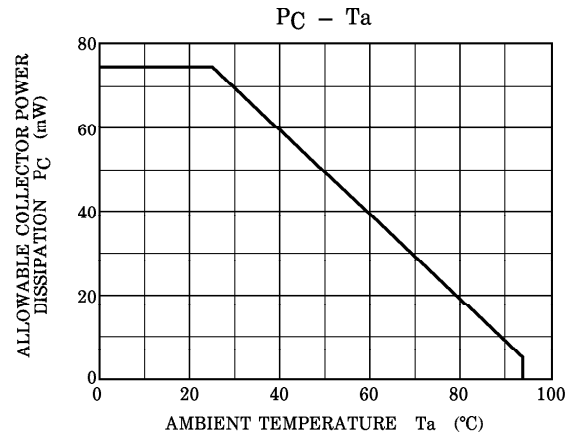
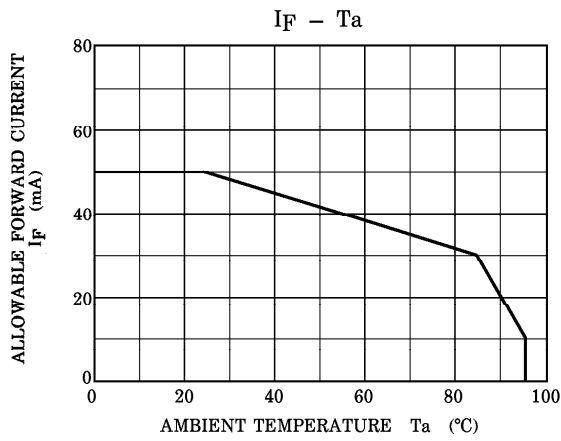

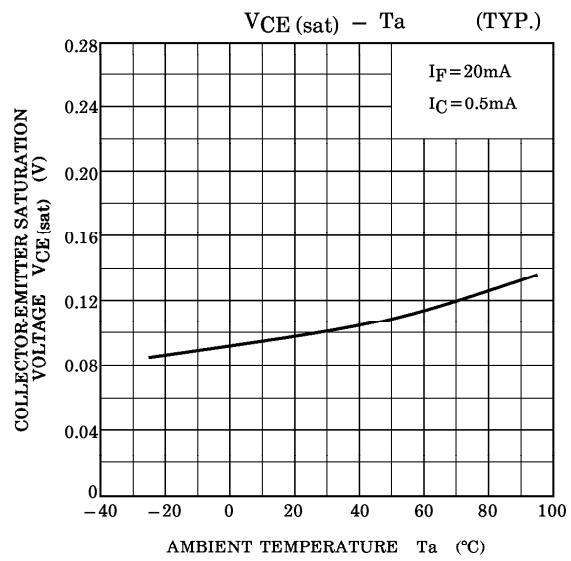
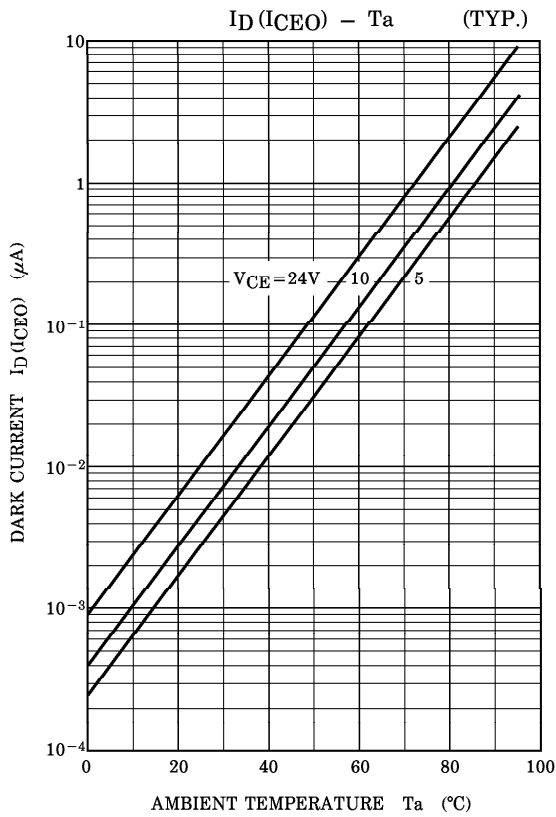
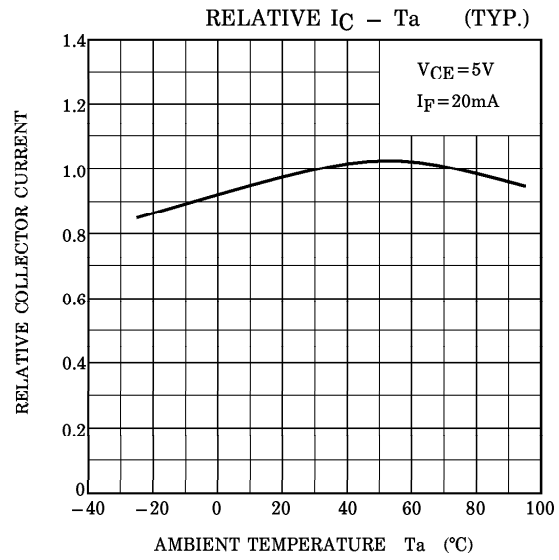
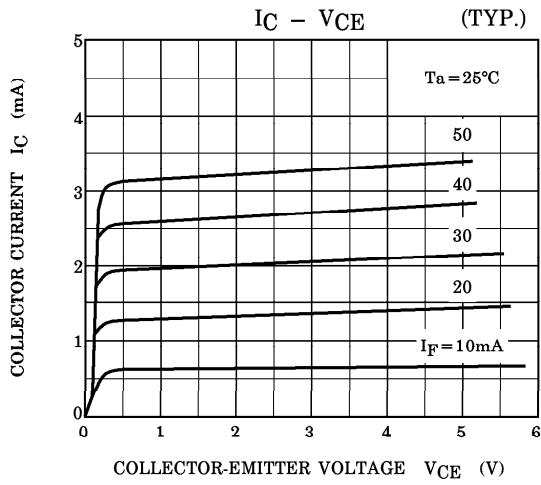

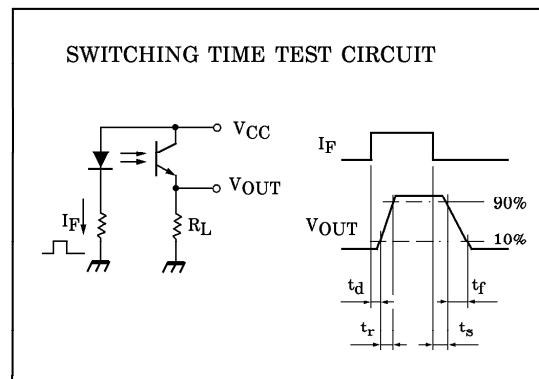
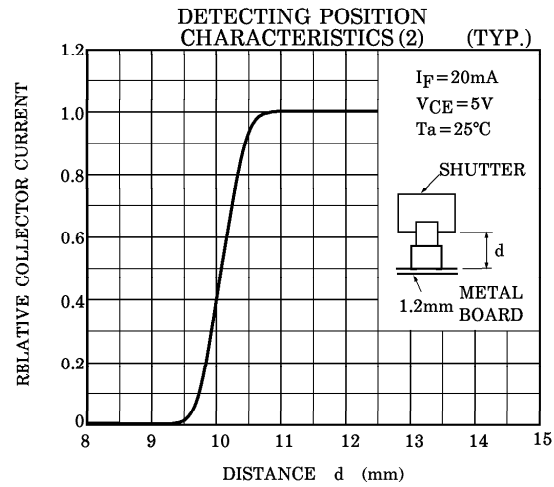
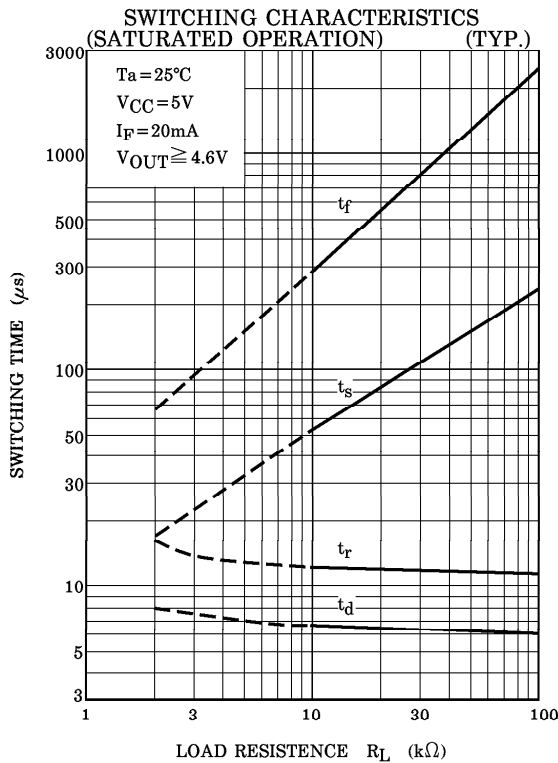
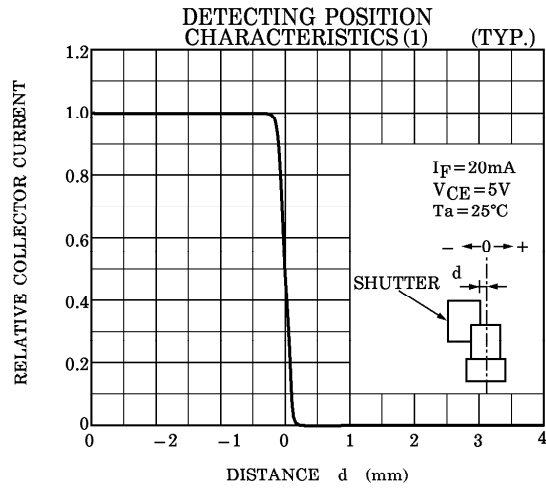
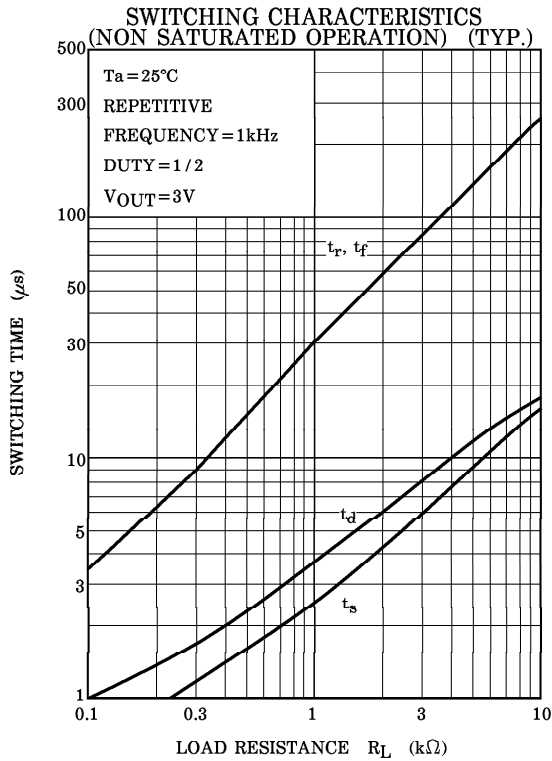

POSITIONING OF SHUTTER AND DEVICE

To operate correctly, make sure that the shutter and the device are positioned as shown in the figure below.

The slit pitch of the shutter must be set wider than the slit width of the device.
 Determine the width taking the switching time into consideration.

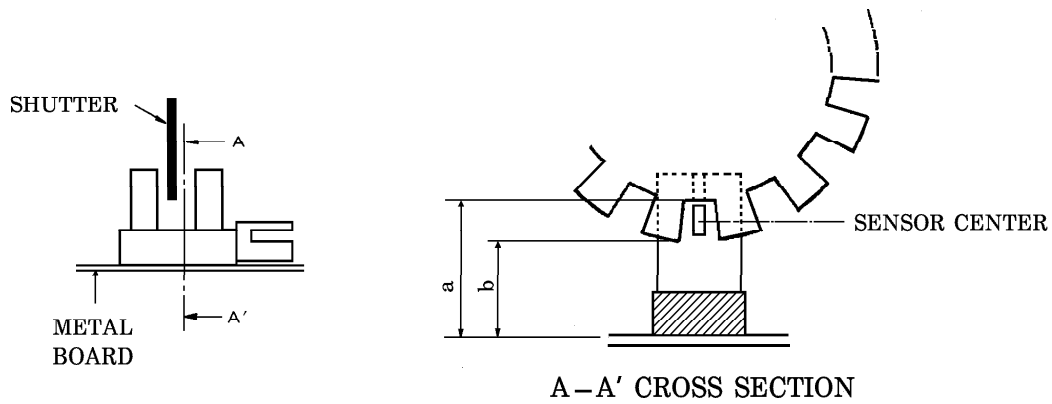

Unit : mm

METAL BOARD THICKNESS	a SIZE	b SIZE
1.0	11.9MIN.	9.4MAX.
1.2	11.7MIN.	9.2MAX.

RECOMMENDED MOUNTING HOLE

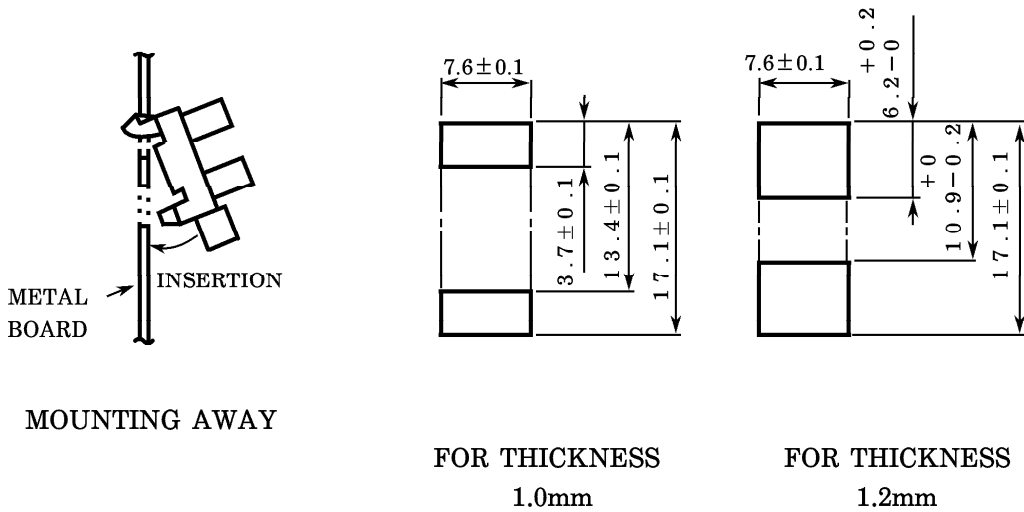

MOUNTING AWAY

FOR THICKNESS
1.0mm

FOR THICKNESS
1.2mm