

TOSHIBA PHOTOINTERRUPTER INFRARED LED + PHOTO IC

TLP1024

PRINTER, ELECTRONIC TYPEWRITER, FACSIMILE
 COPYING MACHINE, LATHER BEAMING PRINTER
 VCR, VIDEODISC, COMPACT DISC
 VARIOUS POSITION DETECTION

TLP1024 is a digital output photointerrupter with a GaAs infrared LED and a high sensitive and high gain Si photo IC combined.

This photointerrupter has a response speed faster than the phototransistor output and is capable of high speed position detection.

Further because of large output current and a built-in Schmitt trigger circuit, this photointerrupter is connectable directly to a microcomputer or logic IC.

Its output becomes low level when the light is shielded. The TLP1034 with a pull-up resistor in the same shape as this photointerrupter is also available.

- Side mounting type
- Gap : 3mm
- Resolution : Slit width 0.5mm
- Digital output (open collector)
- Digital connectable to TTL, LSTTL and CMOS.
- Threshold input current : $I_{FLH}=4\text{mA}$ (Max.) at $T_a=25^\circ\text{C}$
- Operating supply voltage : $V_{CC}=4.5\sim 17\text{V}$
- Built-in Schmitt trigger circuit
- Fast response speed : $t_{pLH}=3\mu\text{s}$, $t_{pHL}=6\mu\text{s}$ (Typ.)
- Detector side is of visible light cut type.

Unit in mm

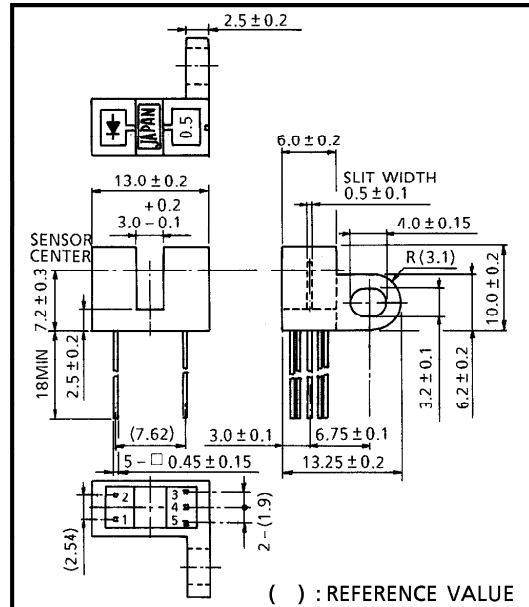

JEDEC	—
EIAJ	—
TOSHIBA	11-13M2

Weight : 0.87g (Typ.)

PIN CONNECTION

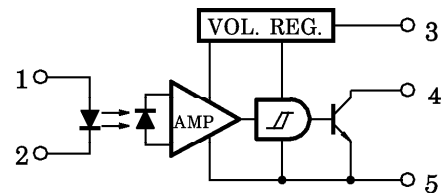

1. ANODE
2. CATHODE
3. V_{CC}
4. OUT
5. GND

961001EBC2

● TOSHIBA is continually working to improve the quality and the reliability of its products. Nevertheless, semiconductor devices in general can malfunction or fail due to their inherent electrical sensitivity and vulnerability to physical stress. It is the responsibility of the buyer, when utilizing TOSHIBA products, to observe standards of safety, and to avoid situations in which a malfunction or failure of a TOSHIBA product could cause loss of human life, bodily injury or damage to property. In developing your designs, please ensure that TOSHIBA products are used within specified operating ranges as set forth in the most recent products specifications. Also, please keep in mind the precautions and conditions set forth in the TOSHIBA Semiconductor Reliability Handbook.

● Gallium arsenide (GaAs) is a substance used in the products described in this document. GaAs dust and fumes are toxic. Do not break, cut or pulverize the product, or use chemicals to dissolve them. When disposing of the products, follow the appropriate regulations. Do not dispose of the products with other industrial waste or with domestic garbage.

● The products described in this document are subject to foreign exchange and foreign trade control laws.

● The information contained herein is presented only as a guide for the applications of our products. No responsibility is assumed by TOSHIBA CORPORATION for any infringements of intellectual property or other rights of the third parties which may result from its use. No license is granted by implication or otherwise under any intellectual property or other rights of TOSHIBA CORPORATION or others.

● The information contained herein is subject to change without notice.

MAXIMUM RATINGS (Ta = 25°C)

CHARACTERISTIC		SYMBOL	RATING	UNIT
LED	Forward Current	I _F	50	mA
	Forward Current Derating (Ta > 25°C)	ΔI _F /°C	-0.33	mA/°C
	Reverse Voltage	V _R	5	V
DETECTOR	Supply Voltage	V _{CC}	17	V
	Output Voltage	V _O	30	V
	Output Current	I _O	50	mA
	Power Dissipation	P _O	250	mW
	Power Dissipation Derating (Ta > 25°C)	ΔP _O /°C	-3.33	mW/°C
Operating Temperature Range		T _{opr}	-25~85	°C
Storage Temperature Range		T _{stg}	-40~100	°C
Soldering Temperature (5s)		T _{sol}	260	°C

RECOMMENDED OPERATING CONDITIONS

CHARACTERISTIC	SYMBOL	MIN.	TYP.	MAX.	UNIT
LED Forward Current	I _F	14*	—	20	mA
Supply Voltage	V _{CC}	4.5	5	17	V
Output Voltage	V _O	—	5	24	V
Low Level Output Current	I _{OL}	—	—	16	mA
Operating Temperature	T _{opr}	-25	—	85	°C

* 14mA is a value when 50% LED deterioration is taken into consideration.
Initial threshold input current shall be 7mA MAX.

OPTO-ELECTRICAL CHARACTERISTICS (Unless Otherwise Specified, Ta = -25~85°C, VCC = 4.5~5.5V)

CHARACTERISTIC		SYMBOL	TEST CONDITION	MIN.	TYP.	MAX.	UNIT	
LED	Forward Current	V_F	$I_F = 10\text{mA}$, $T_a = 25^\circ\text{C}$	1.00	1.15	1.30	V	
	Reverse Current	I_R	$V_R = 5\text{V}$, $T_a = 25^\circ\text{C}$	—	—	10	μA	
	Peak Emission Wavelength	λ_P	$I_F = 25\text{mA}$, $T_a = 25^\circ\text{C}$	—	940	—	nm	
DETECTOR	Supply Voltage	V_{CC}	—	4.5	—	17	V	
	Low Level Supply Current	I_{CCL}	$I_F = 0$	—	—	5.0	mA	
			$I_F = 0$, $V_{CC} = 17\text{V}$	—	—	5.2		
	High Level Supply Current	I_{CCH}	$I_E = 15\text{mA}$	—	—	3.0	mA	
			$I_F = 15\text{mA}$, $V_{CC} = 17\text{V}$	—	—	3.2		
	Low Level Output Voltage	V_{OL}	$I_{OL} = 16\text{mA}$, $I_F = 0$ $T_a = 25^\circ\text{C}$	—	0.07	0.3	V	
			$I_{OL} = 16\text{mA}$, $I_F = 0$ $V_{CC} = 17\text{V}$	—	—	0.4		
High Level Output Current	I_{OH}	$I_F = 15\text{mA}$, $V_O = 30\text{V}$	—	—	15	μA		
Peak Sensitivity Wavelength	λ_P	$T_a = 25^\circ\text{C}$	—	900	—	nm		
COUPLED	Threshold Input Current (L→H)	I_{FLH}	$T_a = 25^\circ\text{C}$	—	—	4	mA	
			$V_{CC} = 17\text{V}$	—	—	7		
	Hysteresis Ratio	I_{FHL} / I_{FLH}	$T_a = 25^\circ\text{C}$	—	0.67	—	—	
	Propagation Delay Time	L→H	t_{pLH}	$V_{CC} = 5\text{V}$, $I_F = 15\text{mA}$ $R_L = 280\Omega$, $T_a = 25^\circ\text{C}$ (Note)	—	3	—	μs
		H→L	t_{pHL}		—	6	—	
Rise Time	t_r		—	0.1	—			
Fall Time	t_f		—	0.05	—			

NOTE : SWITCHING TIME TEST CIRCUIT

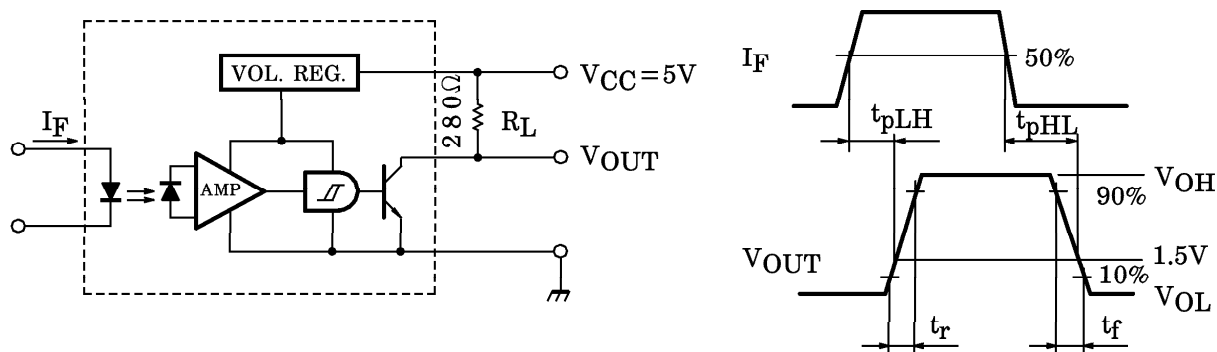

PRECAUTION

Please be careful of the followings.

1. Soldering should be performed after lead forming.
2. If chemicals are used for cleaning, the soldered surface only shall be cleaned with chemicals avoiding the whole cleaning of the package.
3. The container is made of polycarbonate. Polycarbonate is usually stable with acid, alcohol, and aliphatic hydrocarbons however, with peroxochemicals (such as benzene, toluene, and acetone), alkali, aromatic hydrocarbons, or chloric hydrocarbons, polycarbonate becomes cracked, swollen, or melted. Please take care when choosing a packaging material by referencing the table below.

<Chemicals to avoid with polycarbonate>

	PHENOMENON	CHEMICALS
A	Little deterioration but staining	<ul style="list-style-type: none"> • nitric acid (low concentration), hydrogen peroxide, chlorine
B	Cracked, crazed, or swollen	<ul style="list-style-type: none"> • acetic acid (70% or more) • gasoline • methyl ethyl ketone, ethyl acetate, butyl acetate • ethyl methacrylate, ethyl ether, MEK • acetone, m-amino alcohol, carbon tetrachloride • carbon disulfide, trichloroethylene, cresol • thinners, oil of turpentine • triethanolamine, TCP, TBP
C	Melted { } : Used as solvent.	<ul style="list-style-type: none"> • concentrated sulfuric acid • benzene • styrene, acrylonitrile, vinyl acetate • ethylenediamine, diethylenediamine • {chloroform, methyl chloride, tetrachloromethane, dioxane, } • {1, 2-dichloroethane }
D	Decomposed	<ul style="list-style-type: none"> • ammonia water • other alkali

4. During 100 μ s after turning on VCC, output voltage changes for stabilizing the inner circuit.
5. Supply the by-pass condenser up to 0.01 μ F between VCC and GND near device to stabilize the power supply line.
6. Screw shall be tightened to clamping torque of 0.59N·m.

PRODUCT INDICATION

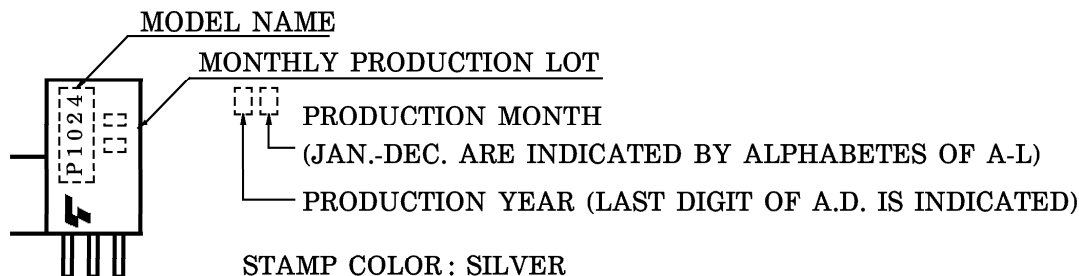

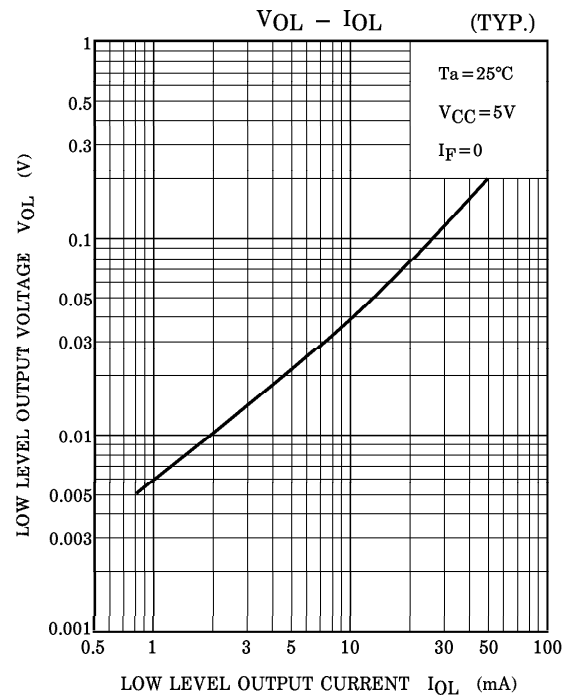
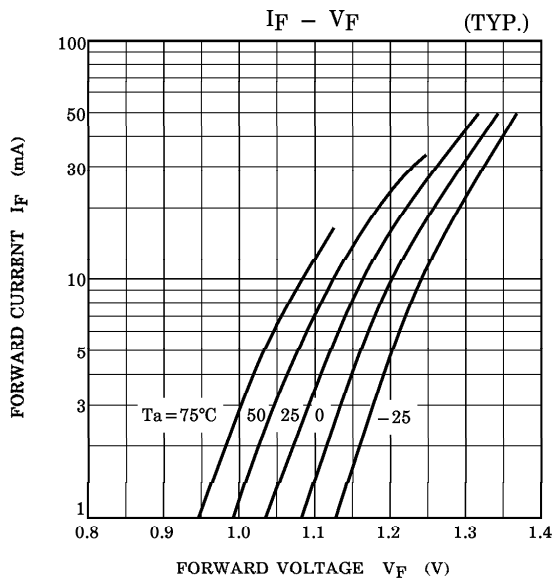
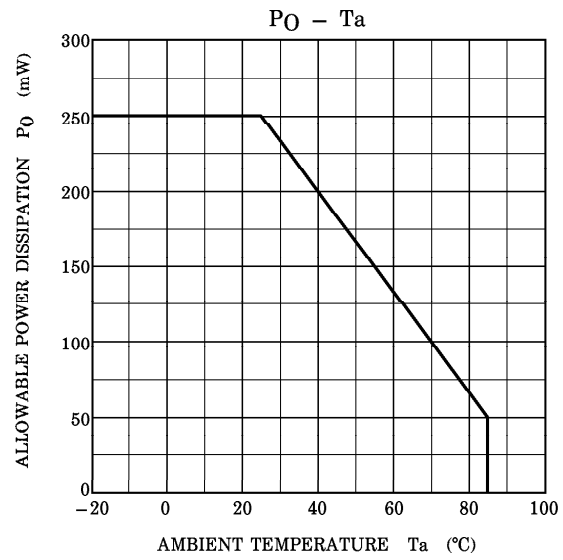
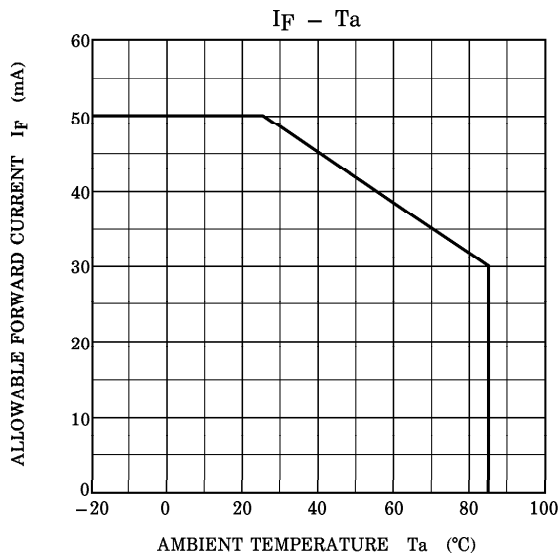

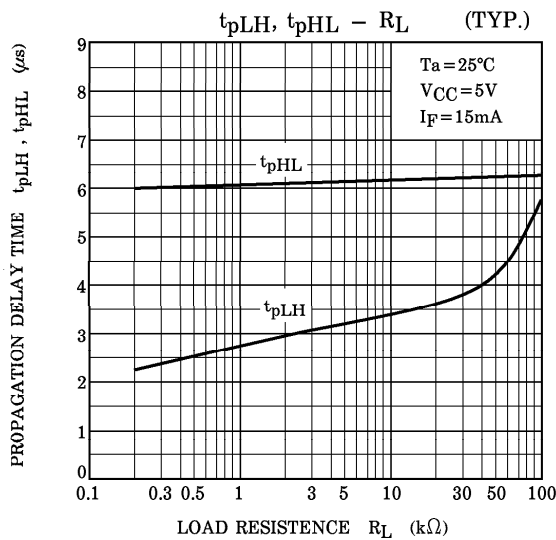
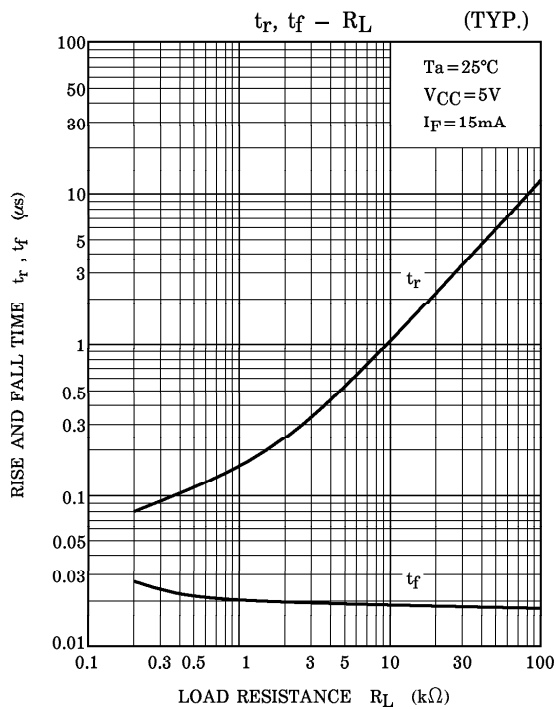
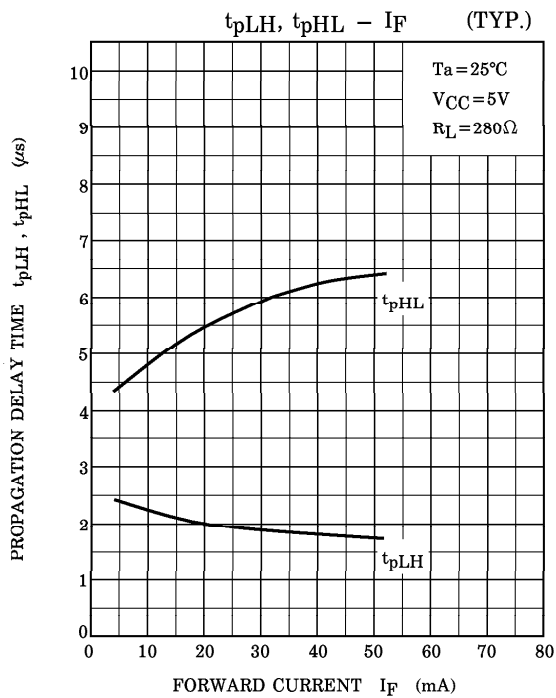

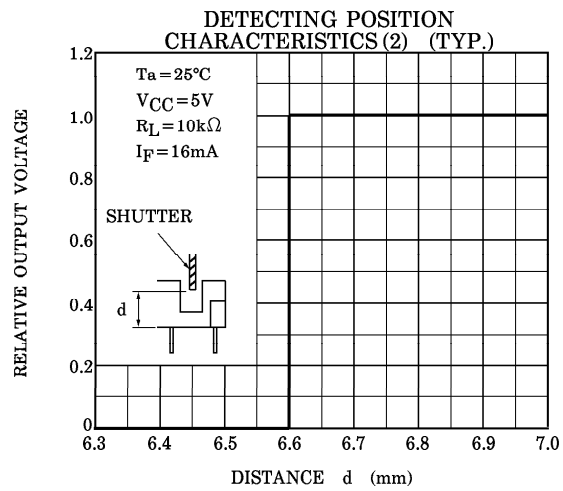
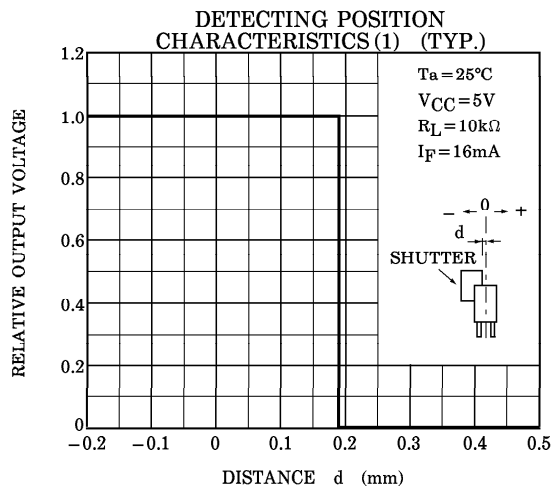

POSITIONING OF SHUTTER AND DEVICE

To operate correctly, make sure that the shutter and the device are positioned as shown in the figure below.

The slit pitch of the shutter must be set wider than the slit width of the device. Determine the width taking the switching time into consideration.

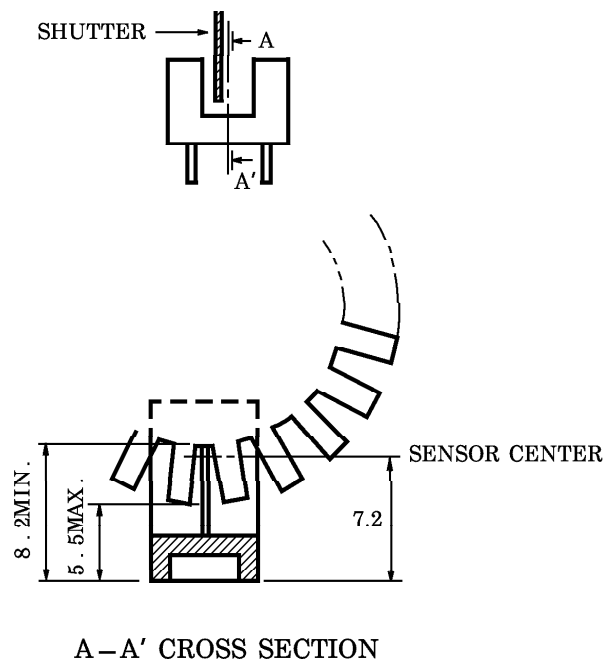

UNIT IN mm