

# Photointerrupter, double-layer mold type

## RPI-352

The RPI-352 is a compact, double-layer mold photointerrupter.

### ●Applications

Floppy disk drives  
Printers  
Facsimiles  
VCR

### ●Features

- 1) Positioning pin enables precision mounting.
- 2) Gap between emitter and detector is 3.0 mm.
- 3) Compact

### ●External dimensions (Units: mm)

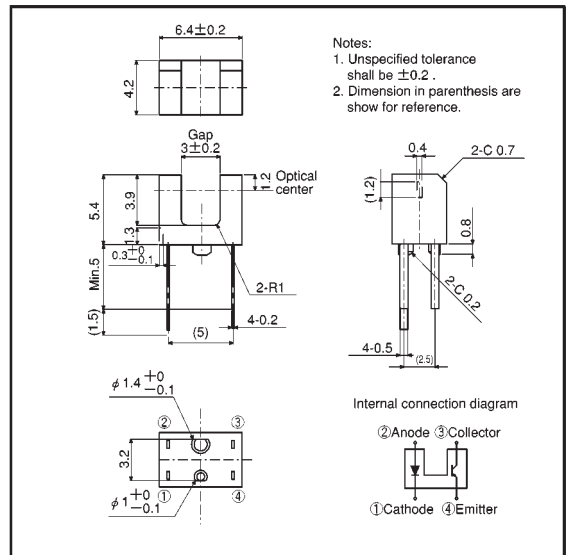

### ●Absolute maximum ratings (Ta = 25°C)

	Parameter	Symbol	Limits	Unit
Input(LED)	Forward current	I <sub>F</sub>	50	mA
	Reverse voltage	V <sub>R</sub>	5	V
	Power dissipation	P <sub>D</sub>	80	mW
Output (photo-transistor)	Collector-emitter voltage	V <sub>CEO</sub>	30	V
	Emitter-collector voltage	V <sub>ECO</sub>	4.5	V
	Collector current	I <sub>C</sub>	30	mA
	Collector power dissipation	P <sub>C</sub>	80	mW
	Operating temperature	T <sub>opr</sub>	-25~+85	°C
	Storage temperature	T <sub>stg</sub>	-30~+85	°C

## ● Electrical and optical characteristics (Ta = 25°C)

Parameter		Symbol	Min.	Typ.	Max.	Unit	Conditions
Input characteristics	Forward voltage	$V_F$	—	1.3	1.6	V	$I_F=50\text{mA}$
	Reverse current	$I_R$	—	—	10	$\mu\text{A}$	$V_R=5\text{V}$
Output characteristics	Dark current	$I_{CEO}$	—	—	0.5	$\mu\text{A}$	$V_{CE}=10\text{V}$
	Peak sensitivity wavelength	$\lambda_P$	—	800	—	nm	—
Transfer characteristics	Collector current	$I_C$	0.2	1.0	—	mA	$V_{CE}=5\text{V}, I_F=20\text{mA}$
	Collector-emitter saturation voltage	$V_{CE(sat)}$	—	—	0.4	V	$I_F=20\text{mA}, I_C=0.1\text{mA}$
	Response time	$t_r \cdot t_f$	—	10	—	$\mu\text{s}$	$V_{CC}=5\text{V}, I_F=20\text{mA}, R_L=100\Omega$

## ● Electrical and optical characteristic curves

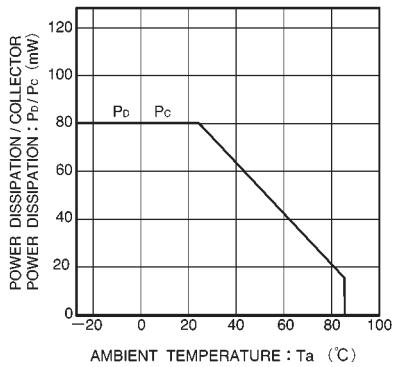

Fig.1 Power dissipation / collector power dissipation vs. ambient temperature

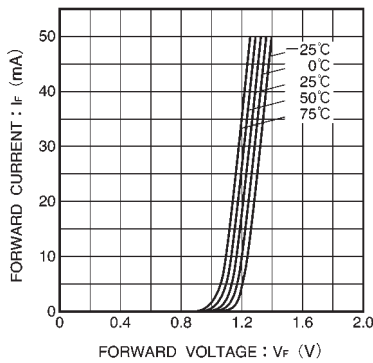

Fig.2 Forward current vs. forward voltage

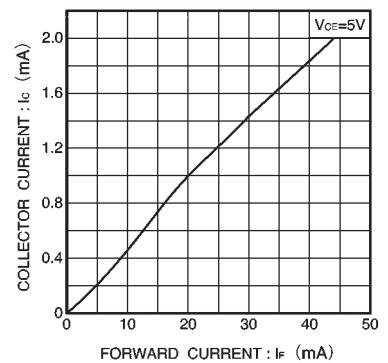

Fig.3 Collector current vs. forward current

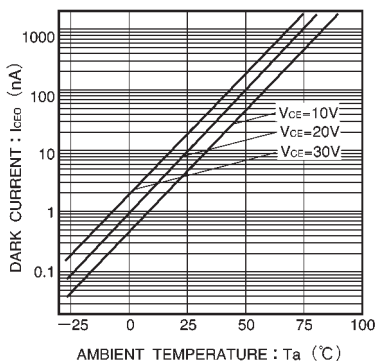

Fig.4 Dark current vs. ambient temperature

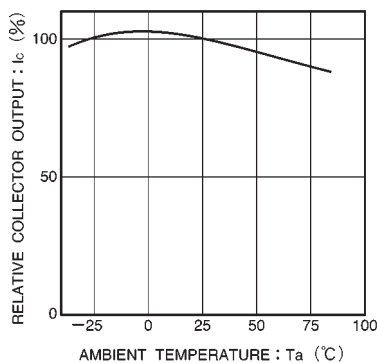

Fig.5 Relative output vs. ambient temperature

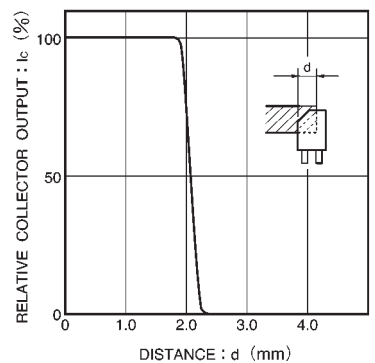

Fig.6 Relative output vs. distance

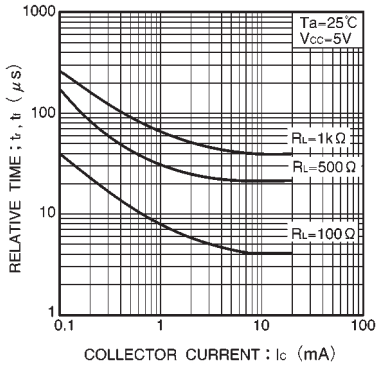

Fig.7 Response time vs. collector current

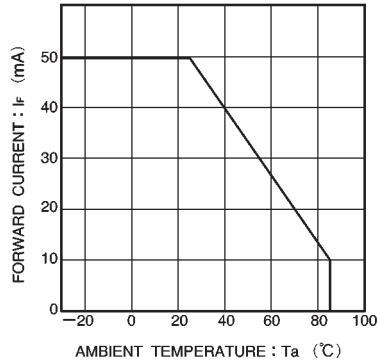

Fig.8 Forward current falloff

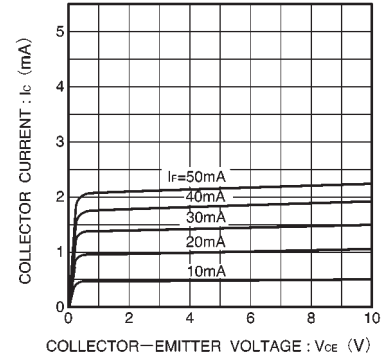
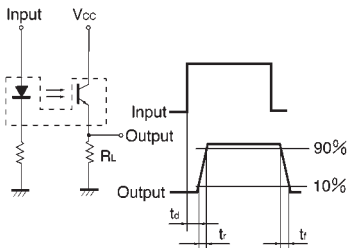

Fig.9 Output characteristics



- $t_d$ : Delay time
- $t_r$ : Rise time (time for output current to rise from 10% to 90% of peak current)
- $t_f$ : Fall time (time for output current to fall from 90% to 10% of peak current)

Fig.10 Response time measurement circuit