

# Photointerrupter, double-layer mold type

## RPI-122

The RPI-122 is an ultra-small size, double-layer mold photointerrupter.

### ●Applications

Optical control equipment  
Cameras  
Floppy disk drives

### ●Features

- 1) Ultra-small.
- 2) Minimal influence from stray light.
- 3) Low collector-emitter saturation voltage.

### ●External dimensions (Units: mm)

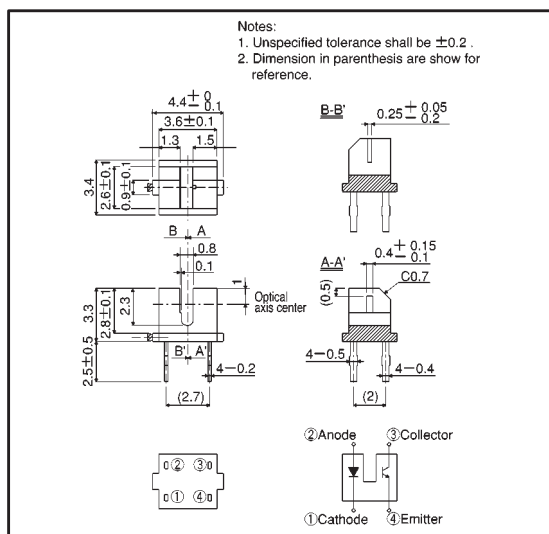

### ●Absolute maximum ratings (Ta = 25°C)

Parameter		Symbol	Limits	Unit
Input(LED)	Forward current	$I_F$	50	mA
	Reverse voltage	$V_R$	5	V
	Power dissipation	$P_D$	80	mW
Output (photo-transistor)	Collector-emitter voltage	$V_{CEO}$	30	V
	Emitter-collector voltage	$V_{ECO}$	4.5	V
	Collector current	$I_C$	30	mA
	Collector power dissipation	$P_C$	80	mW
Operating temperature		$T_{opr}$	-25 ~ +85	°C
Storage temperature		$T_{stg}$	-40 ~ +100	°C

## ● Electrical and optical characteristics (Ta = 25°C)

Parameter		Symbol	Min.	Typ.	Max.	Unit	Conditions
Input characteristics	Forward voltage	$V_F$	—	1.3	1.6	V	$I_F=50\text{mA}$
	Reverse current	$I_R$	—	—	10	$\mu\text{A}$	$V_R=5\text{V}$
	Dark current	$I_{CEO}$	—	—	0.5	$\mu\text{A}$	$V_{CE}=10\text{V}$
Output characteristics	Peak sensitivity wavelength	$\lambda_P$	—	800	—	nm	—
Transfer characteristics	Collector current	$I_C$	0.18	—	1.08	mA	$V_{CE}=0.7\text{V}$ , $I_F=3\text{mA}$
	Collector-emitter saturation voltage	$V_{CE(sat)}$	—	—	0.3	V	$I_F=20\text{mA}$ , $I_C=0.3\text{mA}$
	Response time	$t_r \cdot t_f$	—	10	—	$\mu\text{s}$	$V_{CC}=5\text{V}$ , $I_F=20\text{mA}$ , $R_L=100\Omega$

## ● Electrical and optical characteristic curves

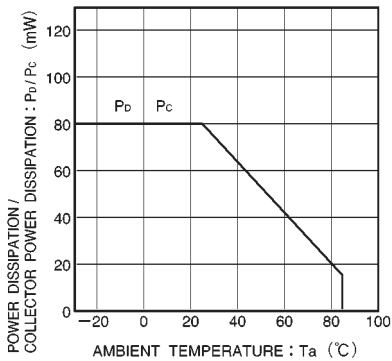

Fig.1 Output vs. ambient temperature

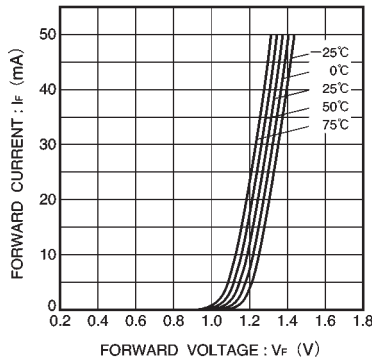

Fig.2 Forward current vs. forward voltage

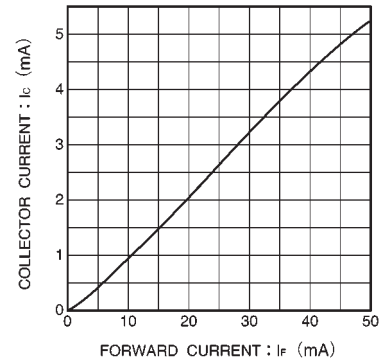

Fig.3 Collector current vs. forward current

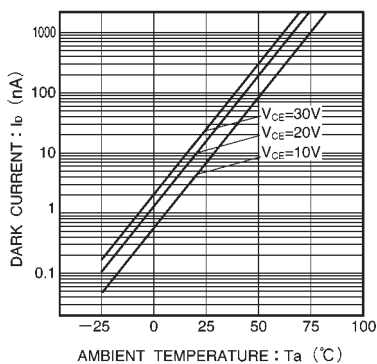

Fig.4 Dark current vs. ambient temperature

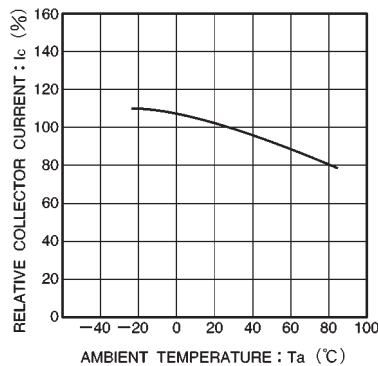

Fig.5 Relative output vs. ambient temperature

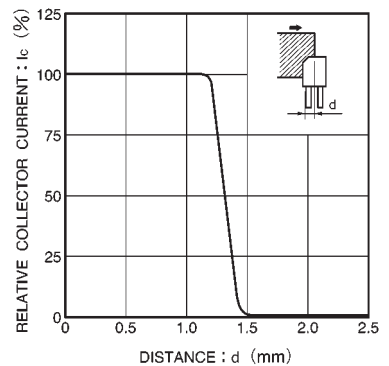

Fig.6 Relative output current vs. distance (I)

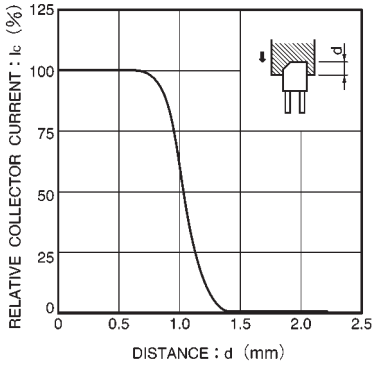

Fig.7 Relative output current vs. distance (II)

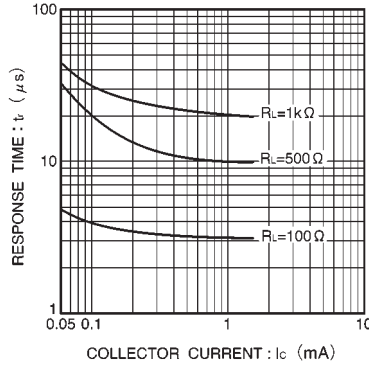

Fig.8 Response time vs. collector current

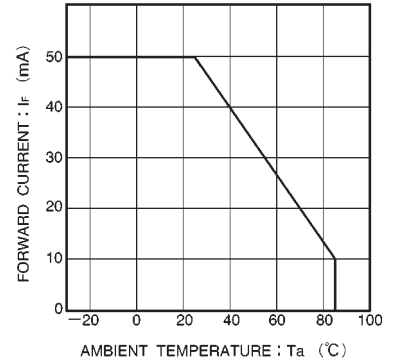

Fig.9 Forward current falloff

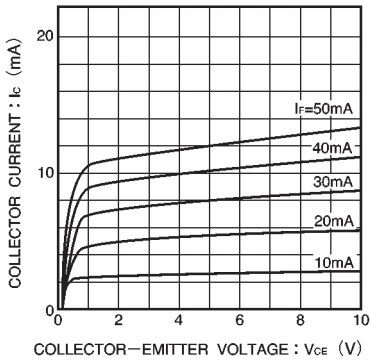

Fig.10 Output characteristics

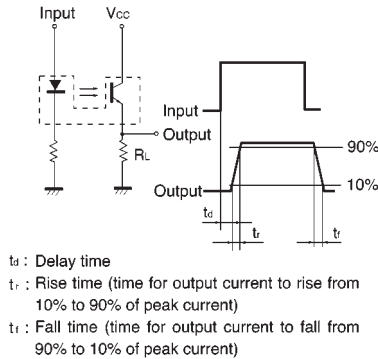

Fig.11 Response time measurement circuit

- $t_d$  : Delay time
- $t_r$  : Rise time (time for output current to rise from 10% to 90% of peak current)
- $t_f$  : Fall time (time for output current to fall from 90% to 10% of peak current)