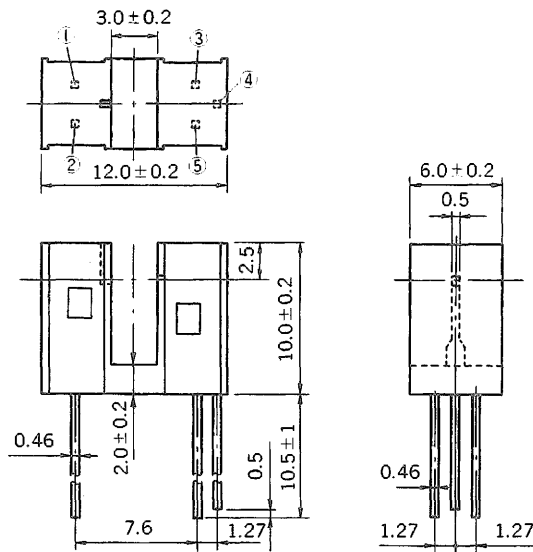

PHOTO INTERRUPTER PS5003HC

PHOTO IC INTERRUPTER

— NEPOC SERIES —

PACKAGE DIMENSIONS (Unit : mm)



CONNECTION DIAGRAM

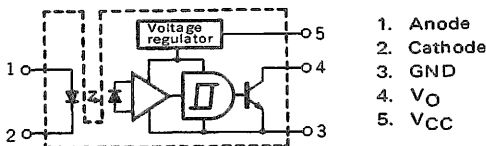

- 1. Anode
- 2. Cathode
- 3. GND
- 4. V_O
- 5. V_{CC}

APPLICATIONS

- PPC
- FACSIMILE
- PRINTER
- FDD

DESCRIPTION

The PS5003HC photo interrupter module is a GaAs Light Emitting Diode coupled to a Si monolithic integrated circuit including a Photo Diode in a plastic housing.

The output incorporates a Schmitt Trigger circuit which provides hysteresis for noise immunity and pulse shaping.

FEATURES

- Built-in Schmitt Trigger circuit
- Low threshold input current ($I_{FLH} = 5 \text{ mA MAX.}$)
- TTL, LSTTL, CMOS compatible
- Wide supply voltage capability ($V_{CC} = 4.5 \text{ to } 17 \text{ V}$)
- High On/Off resolution (Slit width: 0.5 mm (equivalent to 0.5 mm^2 aperture))
- High speed switching ($t_{PLH} (t_{PHL}) = 3 \mu\text{s TYP.}$
 $t_r = 100 \text{ ns}, t_f = 50 \text{ ns TYP.}$
@ $R_L = 280 \Omega$)
- Active "High"
- Open collector output

OUTPUT PATTERN

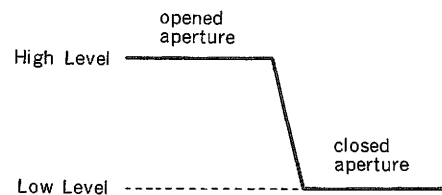

ABSOLUTE MAXIMUM RATINGS ($T_a = 25^\circ\text{C}$)

Diode

Reverse Voltage	V_R	6	V
Forward Current	I_F	50	mA
Power Dissipation	P_D	75	mW

Detector

Supply Voltage	V_{CC}	17	V
Output Voltage	V_O	28	V
Low Level Output Current	I_{OL}	50	mA
Power Dissipation	P_C	250	mW
Storage Temperature	T_{stg}	-40 to +100	$^\circ\text{C}$
Operating Temperature	T_{opt}	-30 to +85	$^\circ\text{C}$

RECOMMENDED OPERATING CONDITIONS ($T_a = 25^\circ\text{C}$)

CHARACTERISTIC	SYMBOL	MIN.	TYP.	MAX.	UNIT
Operating Temperature	T_{opt}	-10		+60	$^\circ\text{C}$
Supply Voltage	V_{CC}	4.5	5	12	V
Forward Current	I_F	5		20	mA

ELECTRICAL CHARACTERISTICS ($T_a = 25^\circ\text{C}$)

CHARACTERISTIC		SYMBOL	MIN.	TYP.	MAX.	UNIT	TEST CONDITIONS
Diode	Forward Voltage	V_F		1.1	1.4	V	$I_F = 5\text{ mA}$
	Reverse Current	I_R			10	μA	$V_R = 5\text{ V}$
	Junction Capacitance	C_t		20		pF	$V = 0, f = 1\text{ MHz}$
Detector	Operating Supply Voltage	V_{CC}	4.5		17	V	
	Low Level Output Voltage	V_{OL}		0.15	0.4	V	$I_{OL} = 16\text{ mA}, V_{CC} = 5\text{ V}$
	High Level Output Voltage	V_{OH}	4.9			V	$V_{CC} = 5\text{ V}, I_F = 5\text{ mA}$
	Low Level Supply Current	I_{CCL}		2.5	5	mA	$V_{CC} = 5\text{ V}, I_F = 0$
Coupled	High Level Supply Current	I_{CCH}		1	3	mA	$V_{CC} = 5\text{ V}, I_F = 5\text{ mA}$
	Threshold Input Current	I_{FLH}			5	mA	$V_{CC} = 5\text{ V}, R_L = 280\ \Omega$
	Hysteresis Ratio	I_{FHL}/I_{FLH}		0.7			$V_{CC} = 5\text{ V}, R_L = 280\ \Omega$
	Propagation Delay Time	t_{PLH}		3	9	μs	$V_{CC} = 5\text{ V}$ $I_F = 5\text{ mA}$ $R_L = 280\ \Omega$
		t_{PHL}		3	9	μs	
	Rise Time	t_r		100	300	ns	
Fall Time	t_f		50	150	ns		

Test Circuit for Switching Time

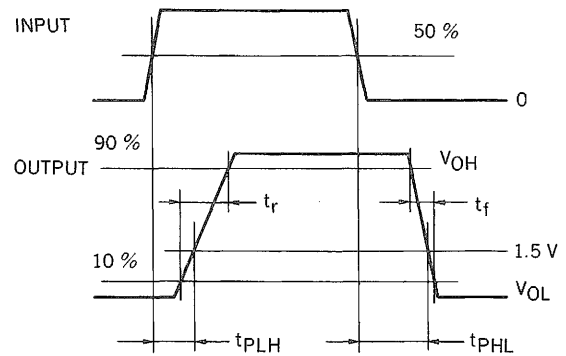
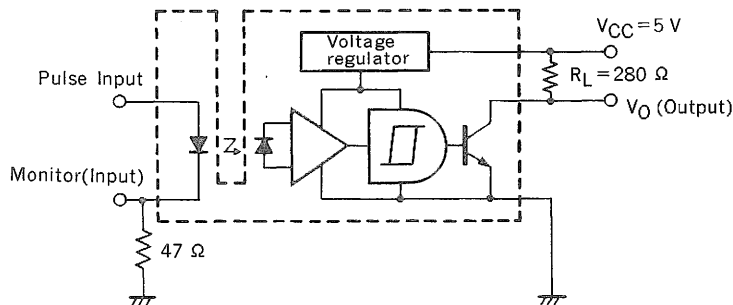
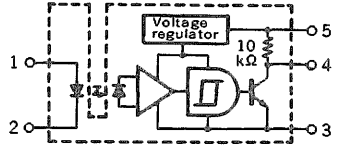
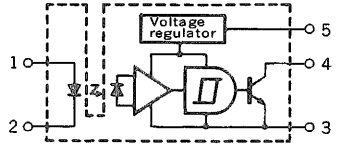
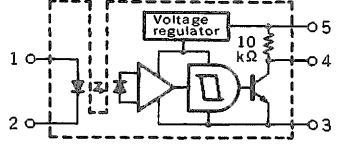
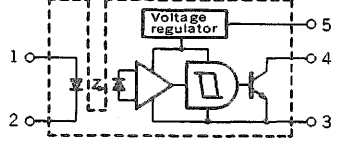

PHOTO IC INTERRUPTER FAMILY

[LINEUP]

PS50XX FAMILY

TYPE No.		OUTPUT		BLOCK DIAGRAM
		OUTPUT PORALITY	OUT TERMINAL	
PS50XX HR SERIES	PS5001HR	active "HIGH"	Built-in pull up resistor	
	PS5002HR			
	PS5003HR			
PS50XX HC SERIES	PS5001HC	active "HIGH"	Open collector output	
	PS5002HC			
	PS5003HC			
PS50XX LR SERIES	PS5001LR	active "LOW"	Built-in pull up resistor	
	PS5002LR			
	PS5003LR			
PS50XX LC SERIES	PS5001LC	active "LOW"	Open collector output	
	PS5002LC			
	PS5003LC			

PS55XX FAMILY

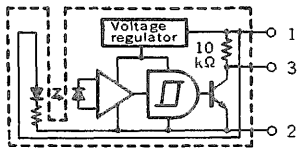
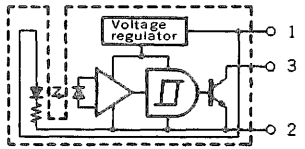
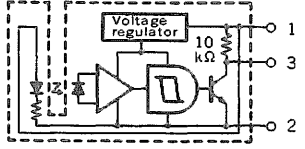
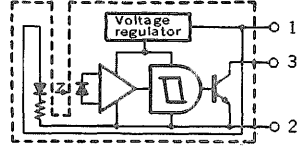
TYPE No.		OUTPUT		BLOCK DIAGRAM
		OUTPUT PORALITY	OUT TERMINAL	
PS5501HR-1*		active "HIGH"	Built-in pull up resistor	
PS5501HC-1*		active "HIGH"	Open collector output	
PS5501LR-1*		active "LOW"	Built-in pull up resistor	
PS5501LC-1*		active "LOW"	Open collector output	

* Suffix No. indicates connector type (Ex. "-1": EI 3pin series 171825-3 made by AMP)

[OUTLINE]

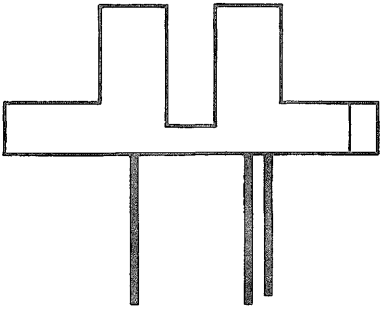
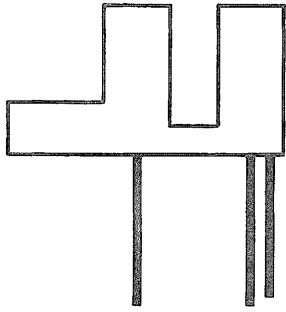
PS5001HR	PS5002HR
PS5001HC	PS5002HC
PS5001LR	PS5002LR
PS5001LC	PS5002LC
	
PS5003HR	PS5501HR-1
PS5003HC	PS5501HC-1
PS5003LR	PS5501LR-1
PS5003LC	PS5501LC-1
