

# PHOTO INTERRUPTER PS5002HC

## PHOTO IC INTERRUPTER

—NEPOC SERIES—

### PACKAGE DIMENSIONS (Unit : mm)

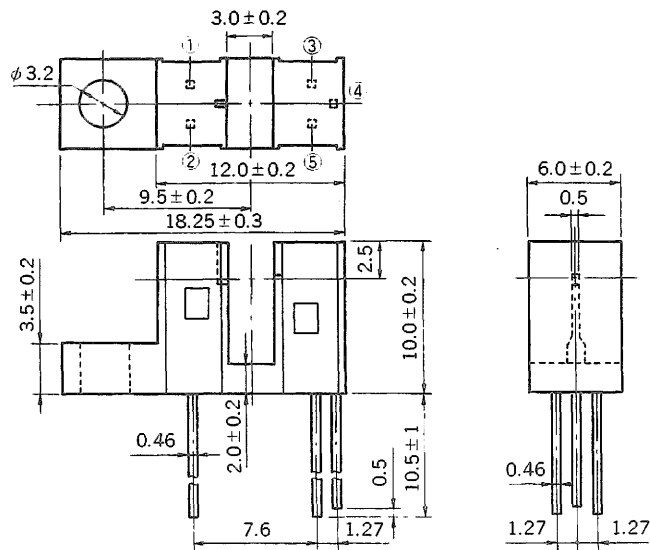

### CONNECTION DIAGRAM

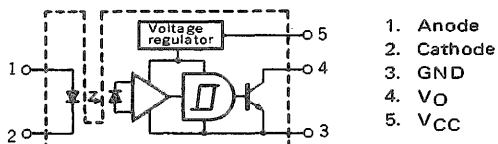

1. Anode
2. Cathode
3. GND
4. VO
5. VCC

### APPLICATIONS

- PPC
- FACSIMILE
- PRINTER
- FDD

### DESCRIPTION

The PS5002HC photo interrupter module is a GaAs Light Emitting Diode coupled to a Si monolithic integrated circuit including a Photo Diode in a plastic housing.

The output incorporates a Schmitt Trigger circuit which provides hysteresis for noise immunity and pulse shaping.

### FEATURES

- Built-in Schmitt Trigger circuit
- Low threshold input current ( $I_{FLH} = 5 \text{ mA MAX.}$ )
- TTL, LSTTL, CMOS compatible
- Wide supply voltage capability ( $V_{CC} = 4.5 \text{ to } 17 \text{ V}$ )
- High On/Off resolution (Slit width: 0.5 mm (equivalent to 0.5 mm<sup>2</sup> aperture))
- High speed switching ( $t_{PLH} (t_{PHL}) = 3 \mu\text{s TYP.}$   
 $t_r = 100 \text{ ns, } t_f = 50 \text{ ns TYP.}$   
@  $R_L = 280 \Omega$ )
- Active "High"
- Open collector output

### OUTPUT PATTERN

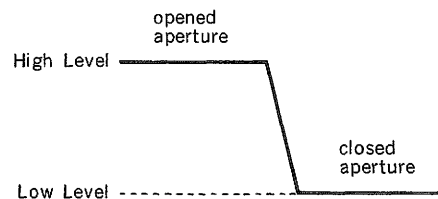

**ABSOLUTE MAXIMUM RATINGS ( $T_a = 25^\circ\text{C}$ )**

**Diode**

Reverse Voltage	$V_R$	6	V
Forward Current	$I_F$	50	mA
Power Dissipation	$P_D$	75	mW

**Detector**

Supply Voltage	$V_{CC}$	17	V
Output Voltage	$V_O$	28	V
Low Level Output Current	$I_{OL}$	50	mA
Power Dissipation	$P_C$	250	mW
Storage Temperature	$T_{stg}$	-40 to +100	$^\circ\text{C}$
Operating Temperature	$T_{opt}$	-30 to +85	$^\circ\text{C}$

**RECOMMENDED OPERATING CONDITIONS ( $T_a = 25^\circ\text{C}$ )**

CHARACTERISTIC	SYMBOL	MIN.	TYP.	MAX.	UNIT
Operating Temperature	$T_{opt}$	-10		+60	$^\circ\text{C}$
Supply Voltage	$V_{CC}$	4.5	5	12	V
Forward Current	$I_F$	5		20	mA

**ELECTRICAL CHARACTERISTICS ( $T_a = 25^\circ\text{C}$ )**

CHARACTERISTIC		SYMBOL	MIN.	TYP.	MAX.	UNIT	TEST CONDITIONS
Diode	Forward Voltage	$V_F$		1.1	1.4	V	$I_F = 5\text{ mA}$
	Reverse Current	$I_R$			10	$\mu\text{A}$	$V_R = 5\text{ V}$
	Junction Capacitance	$C_t$		20		pF	$V = 0, f = 1\text{ MHz}$
Detector	Operating Supply Voltage	$V_{CC}$	4.5		17	V	
	Low Level Output Voltage	$V_{OL}$		0.15	0.4	V	$I_{OL} = 16\text{ mA}, V_{CC} = 5\text{ V}$
	High Level Output Voltage	$V_{OH}$	4.9			V	$V_{CC} = 5\text{ V}, I_F = 5\text{ mA}$
	Low Level Supply Current	$I_{CCL}$		2.5	5	mA	$V_{CC} = 5\text{ V}, I_F = 0$
	High Level Supply Current	$I_{CCH}$		1	3	mA	$V_{CC} = 5\text{ V}, I_F = 5\text{ mA}$
Coupled	Threshold Input Current	$I_{FLH}$			5	mA	$V_{CC} = 5\text{ V}, R_L = 280\ \Omega$
	Hysteresis Ratio	$I_{FHL}/I_{FLH}$		0.7			$V_{CC} = 5\text{ V}, R_L = 280\ \Omega$
	Propagation Delay Time	$t_{PLH}$		3	9	$\mu\text{s}$	$V_{CC} = 5\text{ V}$ $I_F = 5\text{ mA}$ $R_L = 280\ \Omega$
		$t_{PHL}$		3	9	$\mu\text{s}$	
	Rise Time	$t_r$		100	300	ns	
Fall Time	$t_f$		50	150	ns		

Test Circuit for Switching Time

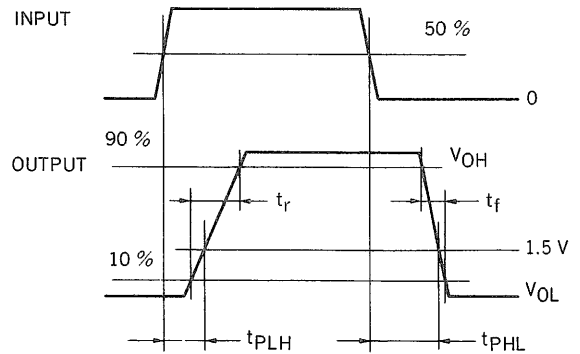
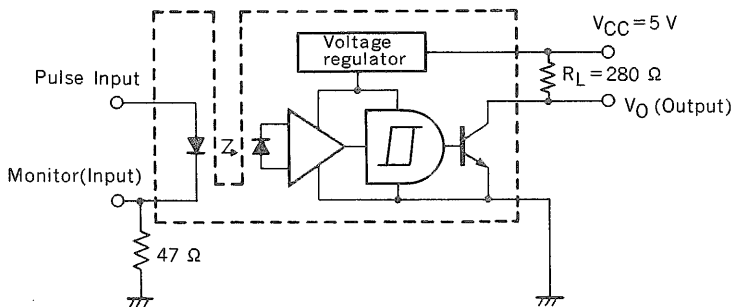
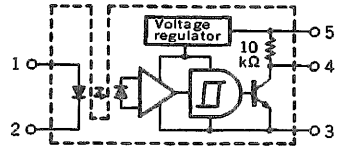
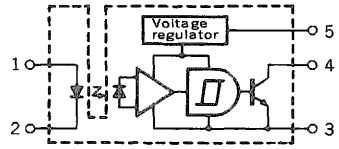
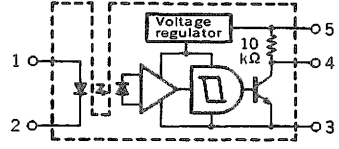
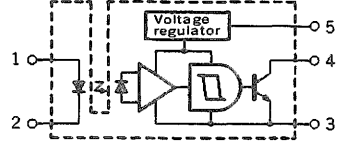

PHOTO IC INTERRUPTER FAMILY

[LINEUP]

PS50XXFAMILY

TYPE No.		OUTPUT		BLOCK DIAGRAM
		OUTPUT PORALITY	OUT TERMINAL	
PS50XXHR SERIES	PS5001HR	active "HIGH"	Built-in pull up resistor	
	PS5002HR			
	PS5003HR			
PS50XXHC SERIES	PS5001HC	active "HIGH"	Open collector output	
	PS5002HC			
	PS5003HC			
PS50XXLR SERIES	PS5001LR	active "LOW"	Built-in pull up resistor	
	PS5002LR			
	PS5003LR			
PS50XXLC SERIES	PS5001LC	active "LOW"	Open collector output	
	PS5002LC			
	PS5003LC			

PS55XXFAMILY

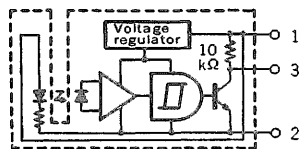
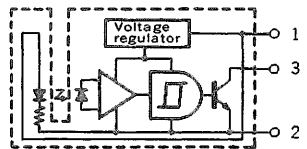
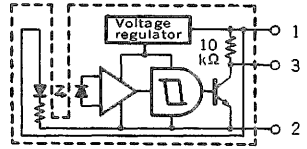
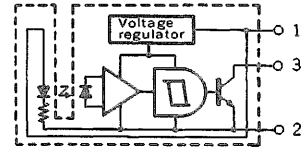
TYPE No.		OUTPUT		BLOCK DIAGRAM
		OUTPUT PORALITY	OUT TERMINAL	
	PS5501HR-1*	active "HIGH"	Built-in pull up resistor	
	PS5501HC-1*	active "HIGH"	Open collector output	
	PS5501LR-1*	active "LOW"	Built-in pull up resistor	
	PS5501LC-1*	active "LOW"	Open collector output	

\* Suffix No. indicates connector type (Ex. "-1": EI 3pin series 171825-3 made by AMP)

[OUTLINE]

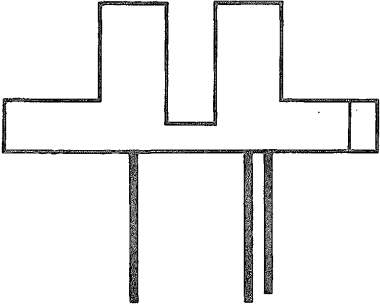
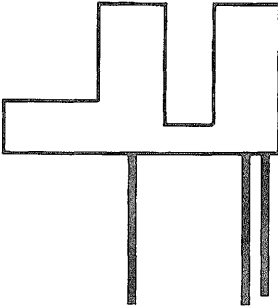
PS5001HR	PS5002HR
PS5001HC	PS5002HC
PS5001LR	PS5002LR
PS5001LC	PS5002LC
	
PS5003HR	PS5501HR-1
PS5003HC	PS5501HC-1
PS5003LR	PS5501LR-1
PS5003LC	PS5501LC-1
