

16-element Si photodiode array



S5668-021

S5668 series

Long and narrow format by multiple arrays

The S5668 series is a 16-element Si photodiode linear array. Each element has an active area of 1.175 mm (width) × 2.0 mm (height) and is arrayed at an element pitch of 1.575 mm. The entire linear array is mounted on a 25.4 mm (1 inch) long PC board. By linearly arranging two or more pieces of the S5668 series, a long and narrow photodiode array can be easily configured at the same element pitch. For X-ray detection applications, the S5668-121 with a CsI (TI) scintillator, the S5668-321 with a ceramic scintillator and the S5668-421 with a fluorescent paper are also available.

Features

- Active area: 1.175 × 2.0 mm/one element
- Element pitch: 1.575 mm
- Mounted on a 1-inch (25.4 mm) long PC board
- Long and narrow format by multiple arrays

Applications

- Non-destructive inspection, etc.

Selection guide

Type No.	Scintillator	Scintillator specifications		Application example
		Afterglow	Cross-talk	
S5668-021	None (epoxy resin potting)	-	-	General photometry
S5668-121	CsI (TI)	Large	Low	X-ray non-destructive inspection of slow-moving objects (baggage inspection, etc.) X-ray applications where signal can be integrated
S5668-321	Ceramic	Small	Low	X-ray non-destructive inspection of fast-moving objects (baggage inspection, etc.)
S5668-421	Phosphor sheet	Small	May occur.	X-ray non-destructive inspection (at low X-ray intensity)



Handling precautions

CsI scintillator of the S5668-121 has deliquescence. Avoid storing or using the S5668-121 at high humidity.

Absolute maximum ratings

Parameter	Symbol	S5668-021	S5668-121/-321/-421	Unit
Reverse voltage	V _R Max.	10	10	V
Operating temperature	T _{opr}	-20 to +60	-10 to +60	°C
Storage temperature	T _{stg}	-20 to +80	-20 to +70	°C

Electrical and optical characteristics (T_a=25 °C, per 1 element)

Parameter	Symbol	Condition	Min.	Typ.	Max.	Unit
Spectral response range	λ		-	340 to 1100	-	nm
Peak sensitivity wavelength	λ_p		-	960	-	nm
Photo sensitivity	S	$\lambda=540$ nm	0.27	0.31	0.35	A/W
		$\lambda=\lambda_p$	0.54	0.60	0.66	
Dark current	I _D	V _R =10 mV	-	5	30	pA
Rise time	t _r	V _R =0 V, R _L =1 k Ω 10 to 90 %	-	0.1	-	μ s
Terminal capacitance	C _t	V _R =0 V, f=10 kHz	20	30	40	pF
Noise equivalent power	NEP	V _R =0 V, $\lambda=540$ nm	-	9.3×10^{-15}	-	W/Hz ^{1/2}
X-ray sensitivity	iscX	*	-021	-	-	nA
			-121	-	6.8	
			-321	-	3.4	
			-421	-	3.2	

* These are for reference (X-ray tube voltage 120 kV, tube current 1.0 mA, aluminum filter t=6 mm, distance 830 mm), X-ray sensitivity depends on the X-ray equipment operating and setup conditions.

Spectral response

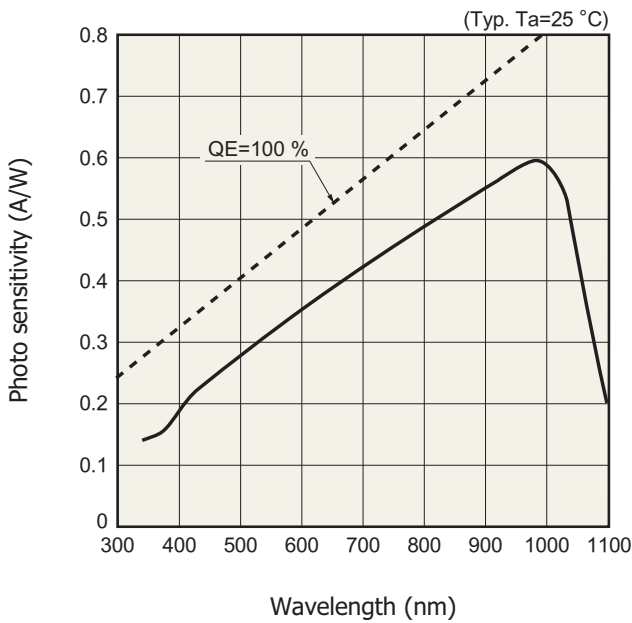

KMPD80277EB

■ Emission spectrum of scintillator and spectral response

S5668-121

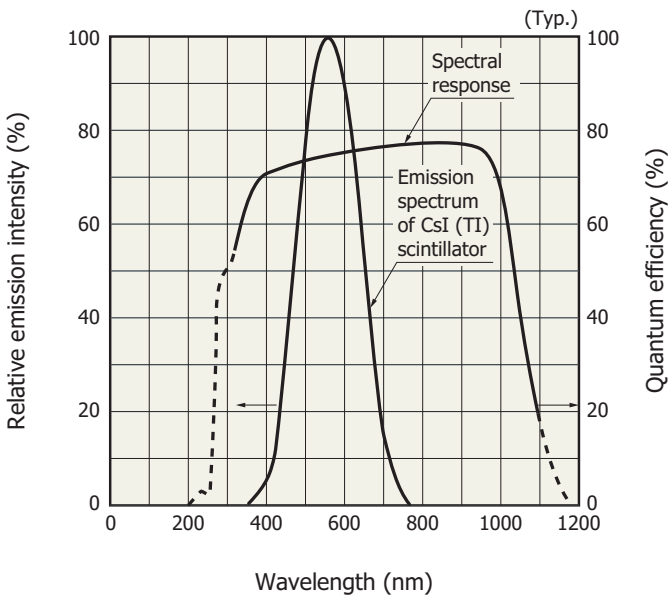

S5668-321

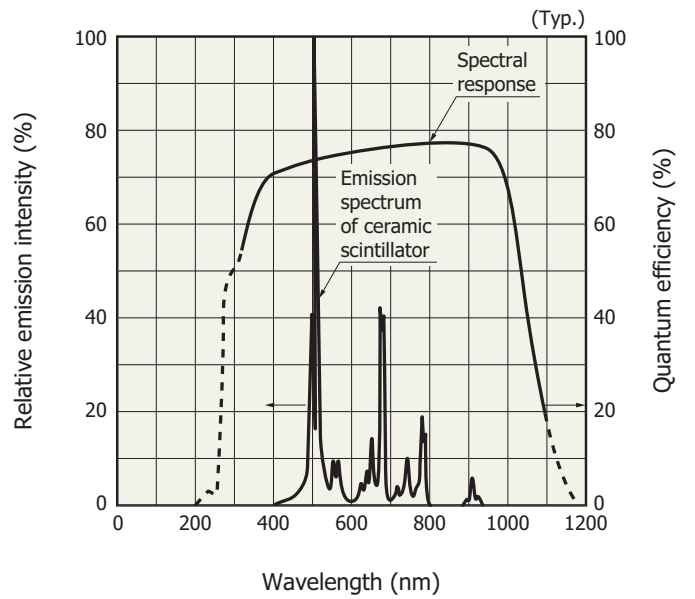

■ Typical scintillator characteristics

Parameter	Condition	CsI (TI)	Ceramic scintillator	Unit
Peak emission wavelength		560	512	nm
X-ray absorption coefficient	100 keV	10	7	cm ⁻¹
Refractive index	at peak emission wavelength	1.74	2.2	-
Decay constant		1	3	μs
Afterglow	100 ms after X-ray turn off	0.3	0.01	%
Density		4.51	7.34	g/cm ³
Color		Transparent	Light yellow-green	-
Sensitivity non-uniformity		±10	±5	%

Dimensional outlines (unit: mm, tolerance: ± 1 mm unless otherwise noted)

S5668-021

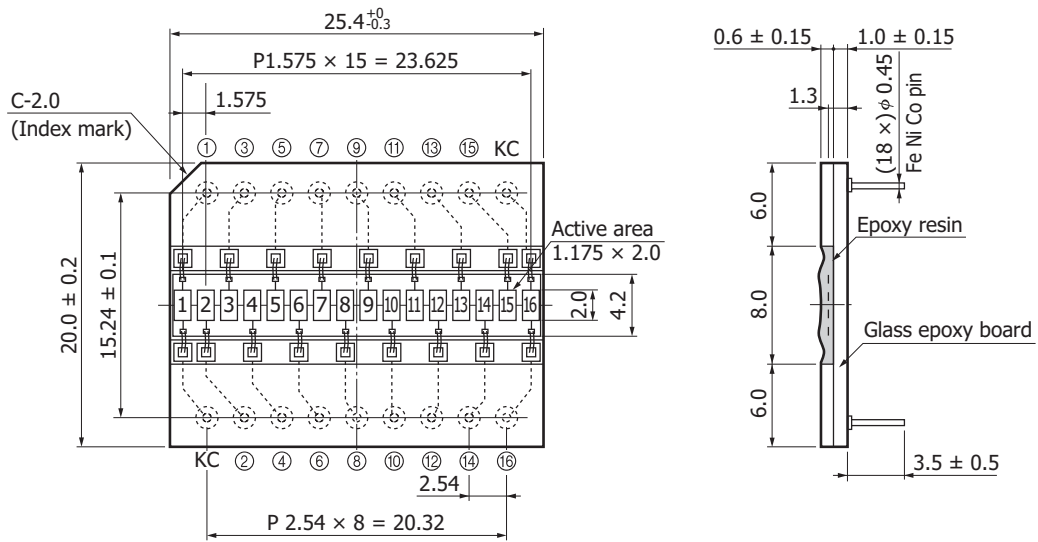

KMPDA0229EB

S5668-121

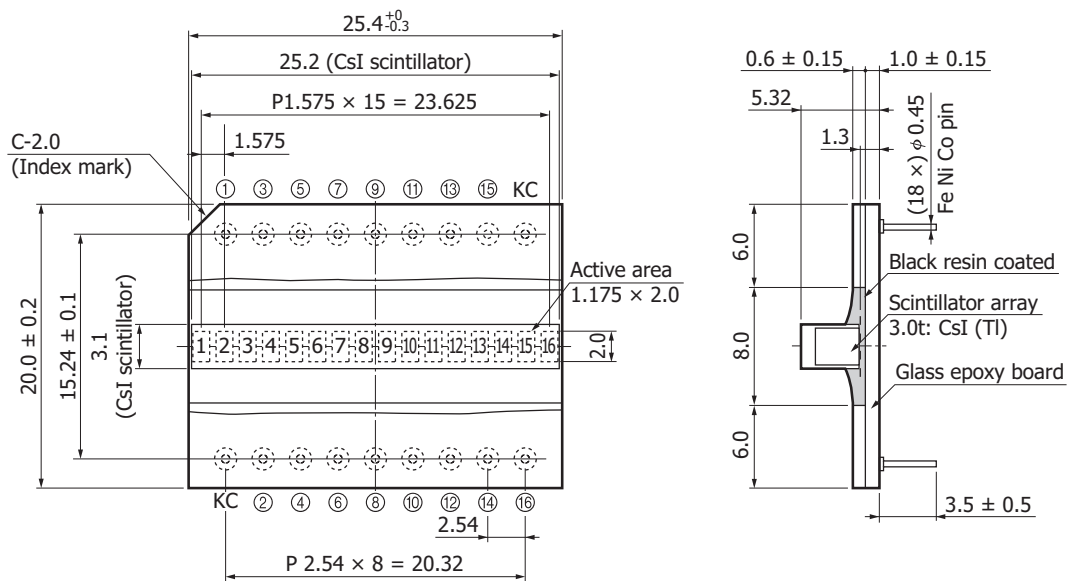

KMPDA0230EB

S5668-321

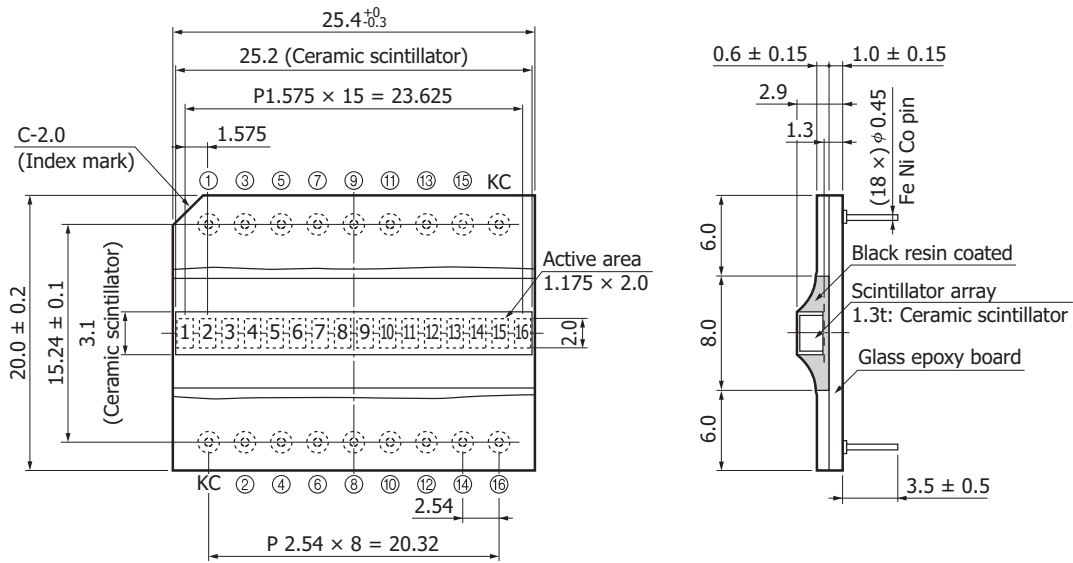

KMPDA0231EA

S5668-421

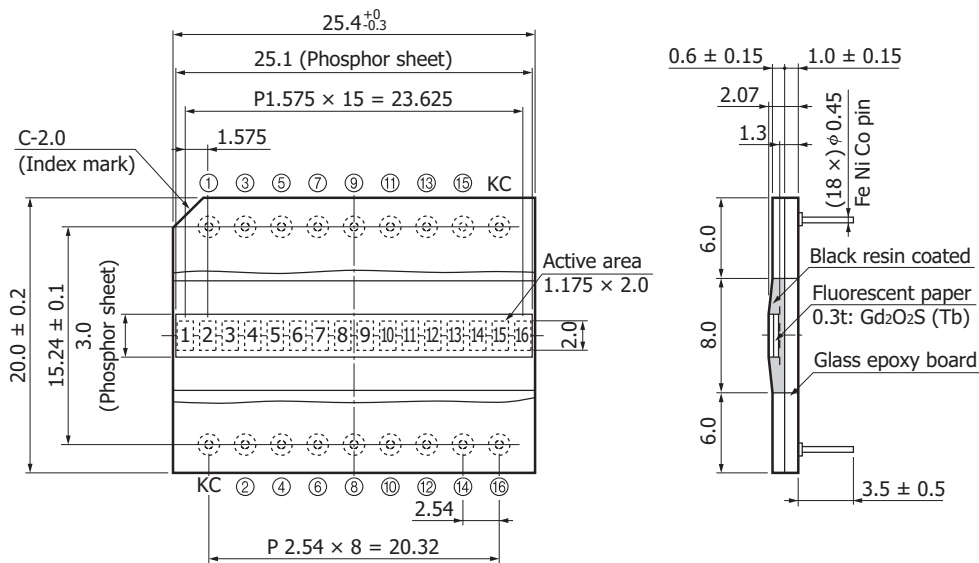

KMPDA0232EA

HAMAMATSU also provides the C9004 driver circuit for Si photodiode arrays, that allows direct mounting of the S5668 series on the circuit board.

Information described in this material is current as of November, 2011.

Product specifications are subject to change without prior notice due to improvements or other reasons. Before assembly into final products, please contact us for the delivery specification sheet to check the latest information.

Type numbers of products listed in the delivery specification sheets or supplied as samples may have a suffix "(X)" which means preliminary specifications or a suffix "(Z)" which means developmental specifications.

The product warranty is valid for one year after delivery and is limited to product repair or replacement for defects discovered and reported to us within that one year period. However, even if within the warranty period we accept absolutely no liability for any loss caused by natural disasters or improper product use.

Copying or reprinting the contents described in this material in whole or in part is prohibited without our prior permission.

HAMAMATSUwww.hamamatsu.com

HAMAMATSU PHOTONICS K.K., Solid State Division

1126-1 Ichino-cho, Higashi-ku, Hamamatsu City, 435-8558 Japan, Telephone: (81) 53-434-3311, Fax: (81) 53-434-5184

U.S.A.: Hamamatsu Corporation: 360 Foothill Road, P.O.Box 6910, Bridgewater, N.J. 08807-0910, U.S.A., Telephone: (1) 908-231-0960, Fax: (1) 908-231-1218

Germany: Hamamatsu Photonics Deutschland GmbH: Arzbergerstr. 10, D-82211 Herrsching am Ammersee, Germany, Telephone: (49) 8152-375-0, Fax: (49) 8152-265-8

France: Hamamatsu Photonics France S.A.R.L.: 19, Rue du Saule Trapu, Parc du Moulin de Massy, 91882 Massy Cedex, France, Telephone: 33-(1) 69 53 71 00, Fax: 33-(1) 69 53 71 10

United Kingdom: Hamamatsu Photonics UK Limited: 2 Howard Court, 10 Tewin Road, Welwyn Garden City, Hertfordshire AL7 1BW, United Kingdom, Telephone: (44) 1707-294888, Fax: (44) 1707-325777

North Europe: Hamamatsu Photonics Norden AB: Smidesvägen 12, SE-171 41 Solna, Sweden, Telephone: (46) 8-509-031-00, Fax: (46) 8-509-031-01

Italy: Hamamatsu Photonics Italia S.R.L.: Strada della Moia, 1 int. 6, 20020 Arese, (Milano), Italy, Telephone: (39) 02-935-81-733, Fax: (39) 02-935-81-741