

S11499 series

Large area, enhanced near IR sensitivity, using a MEMS technology

HAMAMATSU has developed various types of Si detectors that offer enhanced near-infrared sensitivity due to a MEMS structure formed on the back side of the photodiode. The S11499 series is a family of Si PIN photodiodes with drastically improved sensitivity in the near infrared region at wavelengths longer than 900 nm. Compared to our conventional product, the S11499 series has much higher sensitivity to YAG laser light (1.06 μm). It also offers improved temperature characteristics of sensitivity at wavelengths longer than 950 nm.

Features

- High sensitivity: 0.6 A/W ($\lambda=1060$ nm)
- Large active area: $\phi 5.0$ mm (S11499-01)
- High reliability package: TO-5/TO-8 metal package

Applications

- YAG laser monitor

General ratings

Parameter	S11499	S11499-01	Unit
Package	TO-5	TO-8	-
Active area	$\phi 3.0$	$\phi 5.0$	mm

Absolute maximum ratings

Parameter	Symbol	Condition	S11499	S11499-01	Unit
Reverse voltage	V_R max.	$T_a=25$ °C	30		V
Operating temperature	T_{opr}		-40 to +100		°C
Storage temperature	T_{stg}		-55 to +125		°C

Electrical and optical characteristics ($T_a=25$ °C)

Parameter	Symbol	Condition	S11499			S11499-01			Unit
			Min.	Typ.	Max.	Min.	Typ.	Max.	
Spectral response range	λ		-	360 to 1140	-	-	360 to 1140	-	nm
Peak sensitivity wavelength	λ_p		-	1000	-	-	1000	-	nm
Photo sensitivity	S	$\lambda=1060$ nm	0.54	0.6	-	0.54	0.6	-	A/W
Short circuit current	I_{sc}	100 lx	6.0	7.8	-	15	21	-	μA
Dark current	I_D	$V_R=20$ V	-	0.05	5	-	0.1	10	nA
Cut-off frequency	f_c	$V_R=20$ V, -3 dB, $R_L=50$ Ω	-	30	-	-	15	-	MHz
Terminal capacitance	C_t	$V_R=20$ V, $f=1$ MHz	-	13	-	-	33	-	pF

Spectral response

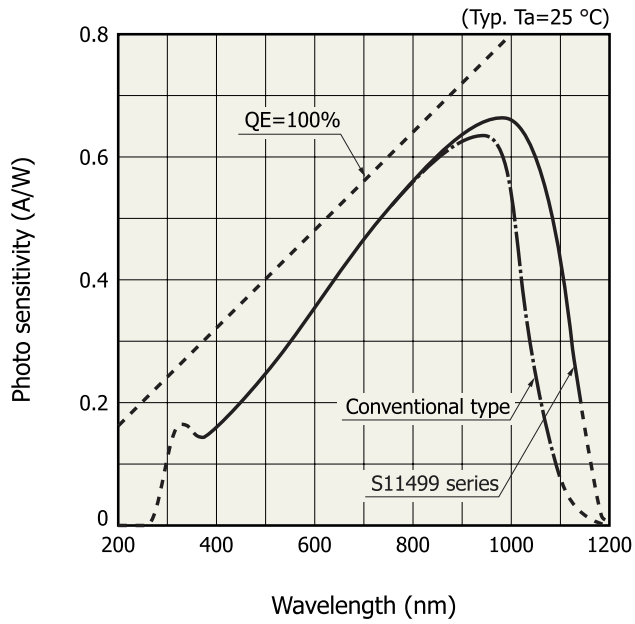
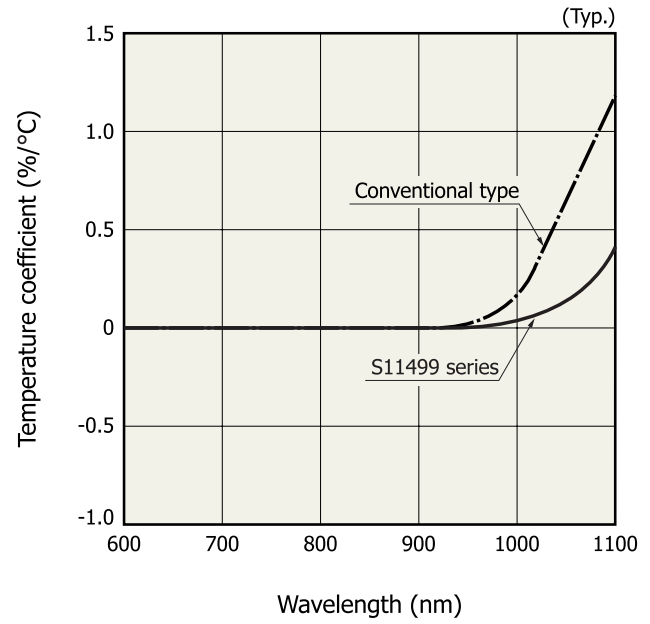
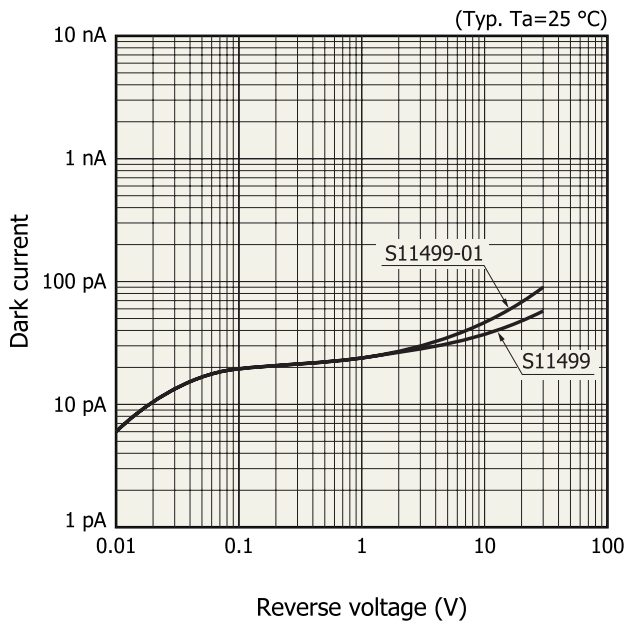

Photo sensitivity temperature characteristic



Dark current vs. reverse voltage



Terminal capacitance vs. reverse voltage

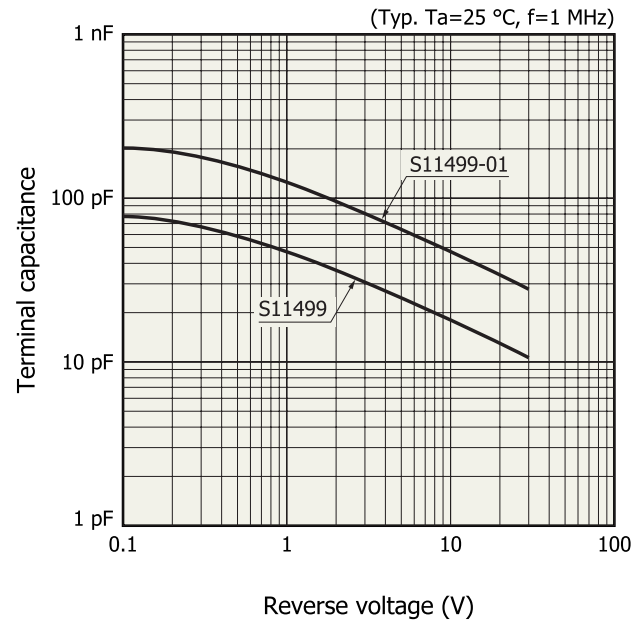

Dimensional outlines (unit: mm)

S11499

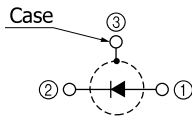
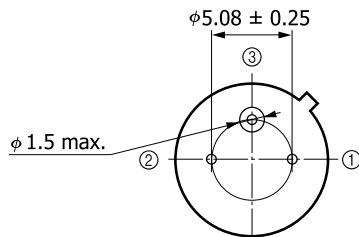
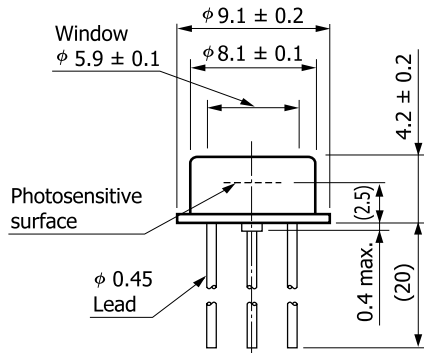

The glass window may extend a maximum of 0.2 mm above the upper surface of the cap.

KPINA0024EB

S11499-01

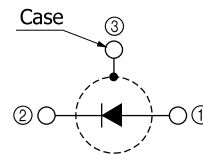
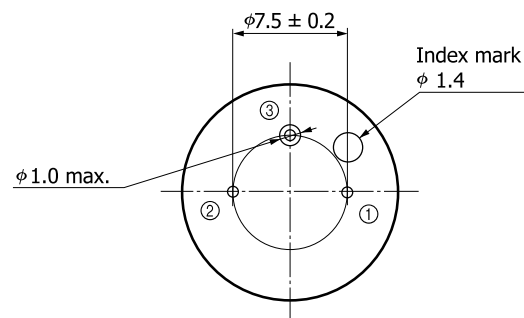
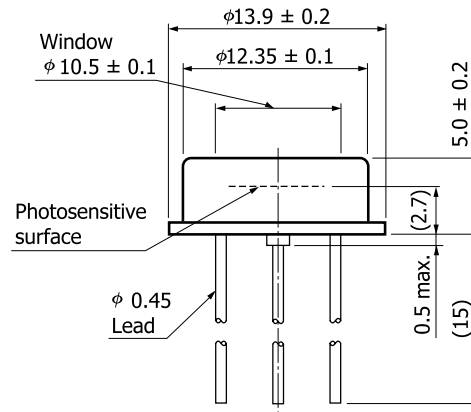

The glass window may extend a maximum of 0.3 mm above the upper surface of the cap.

KPINA0027EC

Information described in this material is current as of January, 2011. Product specifications are subject to change without prior notice due to improvements or other reasons. Before assembly into final products, please contact us for the delivery specification sheet to check the latest information.

Type numbers of products listed in the delivery specification sheets or supplied as samples may have a suffix "(X)" which means preliminary specifications or a suffix "(Z)" which means developmental specifications.

The product warranty is valid for one year after delivery and is limited to product repair or replacement for defects discovered and reported to us within that one year period. However, even if within the warranty period we accept absolutely no liability for any loss caused by natural disasters or improper product use. Copying or reprinting the contents described in this material in whole or in part is prohibited without our prior permission.

HAMAMATSU

www.hamamatsu.com

HAMAMATSU PHOTONICS K.K., Solid State Division

1126-1 Ichino-cho, Higashi-ku, Hamamatsu City, 435-8558 Japan, Telephone: (81) 53-434-3311, Fax: (81) 53-434-5184

U.S.A.: Hamamatsu Corporation: 360 Foothill Road, P.O.Box 6910, Bridgewater, N.J. 08807-0910, U.S.A., Telephone: (1) 908-231-0960, Fax: (1) 908-231-1218

Germany: Hamamatsu Photonics Deutschland GmbH: Arzbergerstr. 10, D-82211 Herrsching am Ammersee, Germany, Telephone: (49) 8152-375-0, Fax: (49) 8152-265-8

France: Hamamatsu Photonics France S.A.R.L.: 19, Rue du Saule Trapu, Parc du Moulin de Massy, 91882 Massy Cedex, France, Telephone: 33-(1) 69 53 71 00, Fax: 33-(1) 69 53 71 10

United Kingdom: Hamamatsu Photonics UK Limited: 2 Howard Court, 10 Tewin Road, Welwyn Garden City, Hertfordshire AL7 1BW, United Kingdom, Telephone: (44) 1707-294888, Fax: (44) 1707-325777

North Europe: Hamamatsu Photonics Norden AB: Smidesvägen 12, SE-171 41 Solna, Sweden, Telephone: (46) 8-509-031-00, Fax: (46) 8-509-031-01

Italy: Hamamatsu Photonics Italia S.R.L.: Strada della Moia, 1 int. 6, 20020 Arese, (Milano), Italy, Telephone: (39) 02-935-81-733, Fax: (39) 02-935-81-741