

## PIN PHOTODIODE

— NEPOC SERIES —

The PH320 is a PIN structure photodiode which is molded with visible-ray shielding resin, thus activating the light-receiving sensitivity at approx. 840 nm and leading to little possibility of malfunction by fluorescent lamps.

As the high-speed response is possible and the infrared ray sensitivity ( $\lambda = 940$  nm) is the same as PH302C, PH309 and PH310, it is ideally suited for various types of remote control applications.

## FEATURES

- Ultra high speed response ( $t_r = 30$  ns,  $t_f = 50$  ns TYP.)
- Superlative wave matching the characteristic for infrared LED ( $\lambda_{max.} = 990$  nm TYP.)
- Light receiving sensitivity:  
4.4  $\mu$ A (@  $V_R = 5$  V,  $H = 0.1$   $\mu$ W/cm<sup>2</sup>)
- Compact package
- Infrared-ray filter resin molding (Rise wavelength: 840 nm)

## QUALITY GRADE

Standard

Please refer to "Quality grade on NEC Semiconductor Devices" (Document number IEI-1209) published by NEC Corporation to know the specification of quality grade on the devices and its recommended applications.

## APPLICATIONS

- Photosensor for TV remote control.

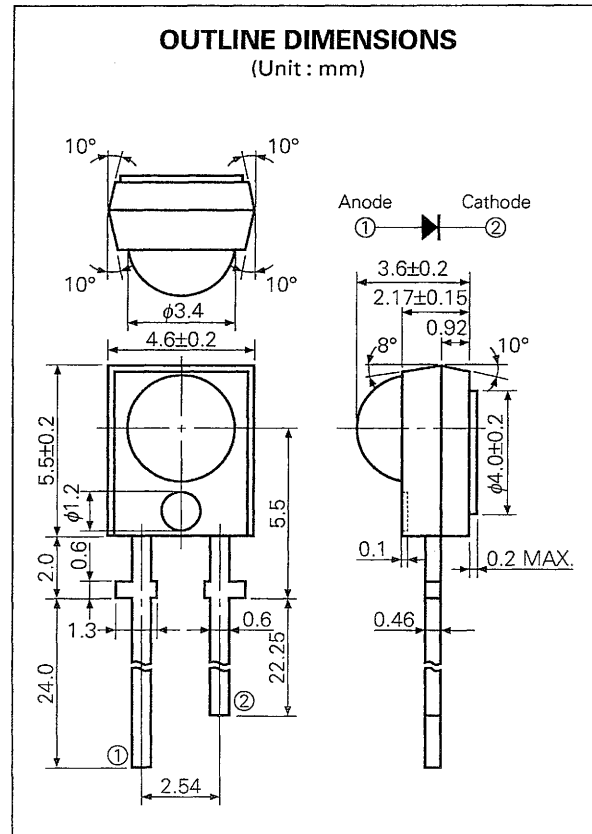

**ABSOLUTE MAXIMUM RATINGS (T<sub>a</sub> = 25 °C)**

Reverse Voltage	V <sub>R</sub>	32	V
Power Consumption	P <sub>D</sub>	100	mW
Operating Temperature	T <sub>opt</sub>	-30 to +85	°C
Storage Temperature	T <sub>stg</sub>	-40 to +100	°C

**ELECTRICAL CHARACTERISTICS (T<sub>a</sub> = 25 °C)**

ITEMS	SYMBOL	MIN.	TYP.	MAX.	UNIT	CONDITIONS
Dark current	I <sub>R</sub>			10	nA	V <sub>R</sub> = 10 V
Maximum sensitivity wavelength	λ <sub>MAX</sub> *1		940		nm	
Product maximum sensitivity wavelength	λ <sub>SMAX</sub> *2		990		nm	
Quantum efficiency	η		0.88			λ = 940 nm
Infrared ray sensitivity	S <sub>IR</sub>	3.6	4.4		μA	V <sub>R</sub> = 5 V, H = 0.1 μW/cm <sup>2</sup>
Rise time	t <sub>r</sub>		30		ns	R <sub>L</sub> = 1 kΩ, V <sub>R</sub> = 5 V, λ = 940 nm
Fall time	t <sub>f</sub>		50			R <sub>L</sub> = 1 kΩ, V <sub>R</sub> = 5 V, λ = 940 nm
Capacitance between terminal	C <sub>t</sub>		8		pF	V <sub>R</sub> = 5 V, f = 1 MHz
Light receiving area	A		3.6		mm <sup>2</sup>	—

\*1 λ<sub>MAX</sub> : PIN photodiode chip maximum sensitivity wavelength

\*2 λ<sub>SMAX</sub> : Maximum sensitivity wavelength as a product including molding resin

**RECOMMENDED APPLICATION**

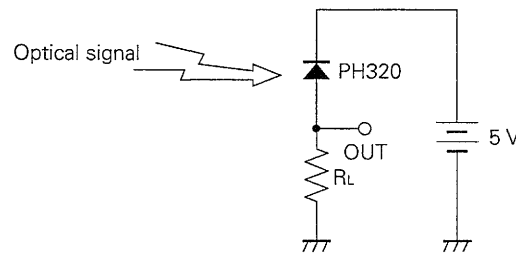

**STANDARD CHARACTERISTICS (T<sub>a</sub> = 25 °C)**

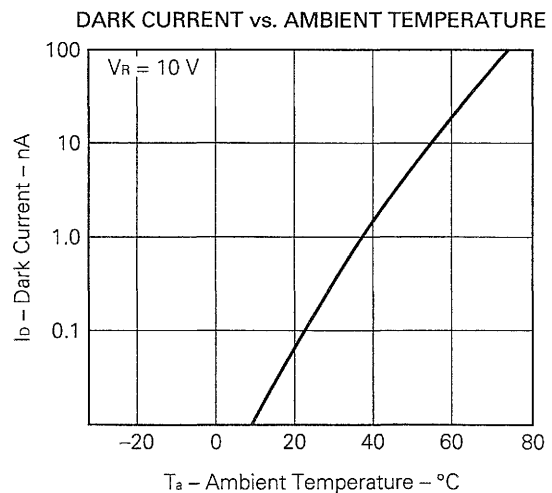
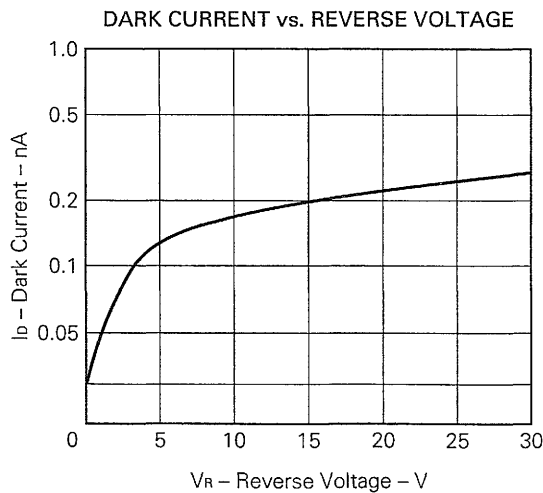

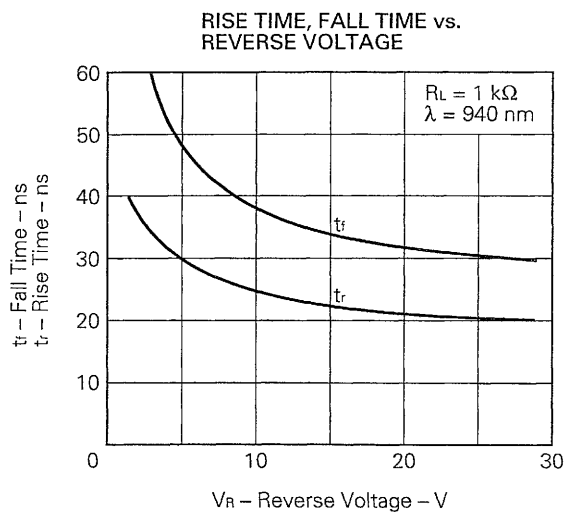
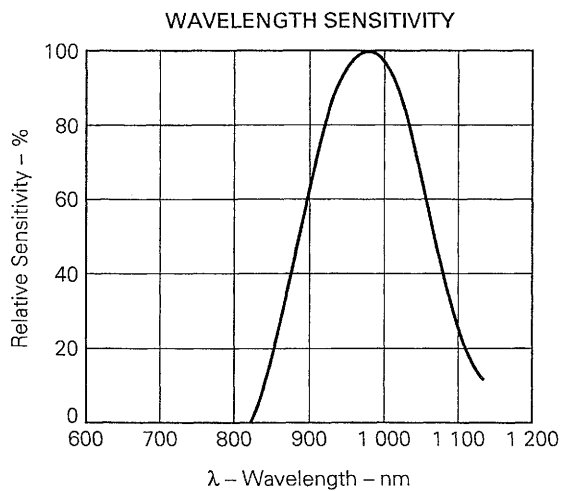

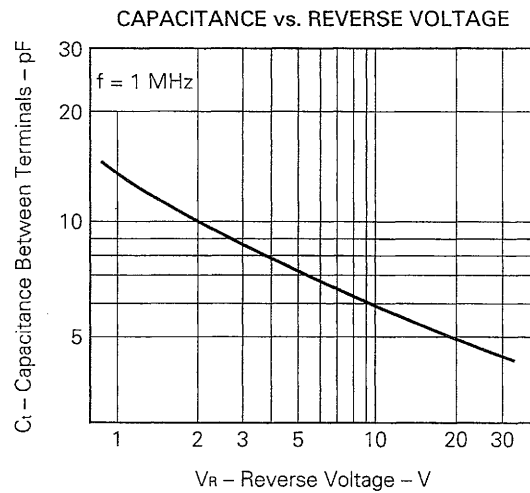
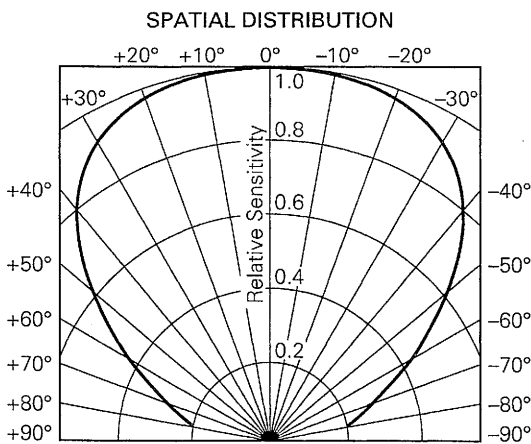
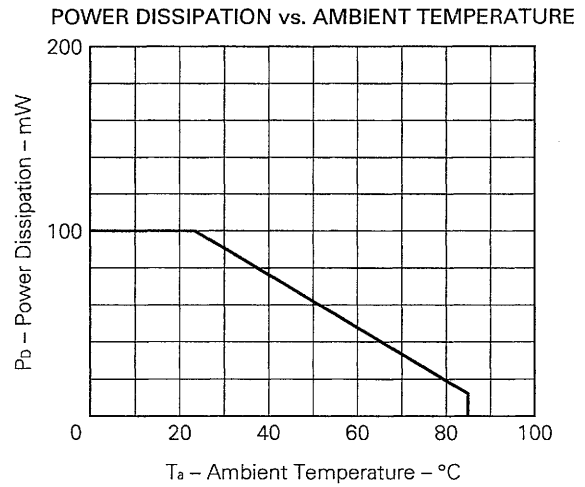
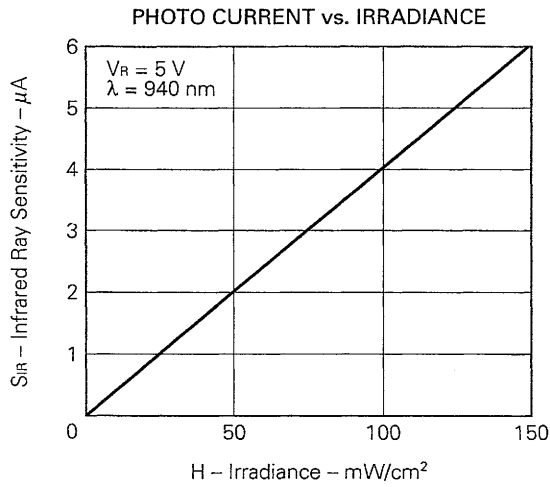
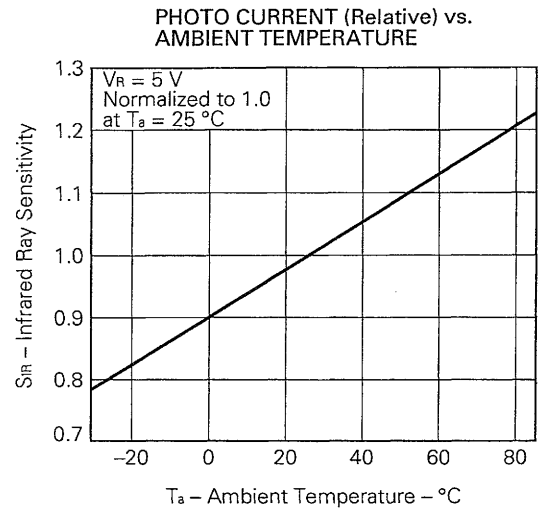
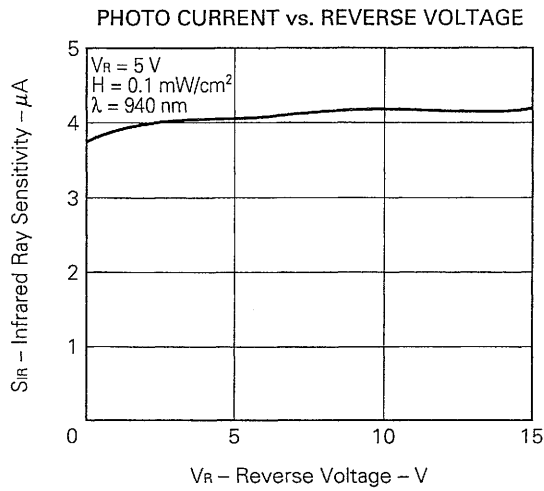

**HANDLING PRECAUTIONS:**

1. The full resin-molded PH320 has generally a little less mechanical and thermal strength than other resin-molded semiconductor devices as they have less additives. Therefore please note on the following points.
  - (a) Soldering of leads should be made at the point 3 mm or more from the root of the leads at 260 °C and within 5 s.
  - (b) If the temperature of the molded portion rises in addition to the residual stress between the leads, the possibility that open or short circuit occurs due to the deformation or destruction of the resin will increase.
  
2. On cleaning the device:
  - (a) Cleaning with unsuitable solvent may impair the resin if the package and the following solvents should be used at the temperature of less than 45 °C and for less than 3 minutes of immersion time.
    - Freon TE, Freon TF, Ethanol, Methanol
    - Difron-solvent, Isopropyl-alcohol
  - (b) Ultrasonic cleaning will add some stress on devices. The degree of the stress differs depending on the oscillation output power, the size of the PCB and the mounting methods of the devices, therefore it should be confirmed by making an experiment at actual conditions that the cleaning does not have any problem on the devices.

[MEMO]

No part of this document may be copied or reproduced in any form or by any means without the prior written consent of NEC Corporation. NEC Corporation assumes no responsibility for any errors which may appear in this document.

NEC Corporation does not assume any liability for infringement of patents, copyrights or other intellectual property rights of third parties by or arising from use of a device described herein or any other liability arising from use of such device. No license, either express, implied or otherwise, is granted under any patents, copyrights or other intellectual property rights of NEC Corporation or others.

The devices listed in this document are not suitable for use in aerospace equipment, submarine cables, nuclear reactor control systems and life support systems. If customers intend to use NEC devices for above applications or they intend to use "Standard" quality grade NEC devices for applications not intended by NEC, please contact our sales people in advance.

Application examples recommended by NEC Corporation.

Standard: Computer, Office equipment, Communication equipment, Test and Measurement equipment, Machine tools, Industrial robots, Audio and Visual equipment, Other consumer products, etc.

Special: Automotive and Transportation equipment, Traffic control systems, Antidisaster systems, Anticrime systems, etc.