

PD413PI

High Speed Type Photodiode

■ Features

1. Built-in visible light cut-off filter
(Sensitivity wavelength range : 750 to 1070 nm)
2. Half intensity angle : $\Delta\theta : \pm 45^\circ$

■ Applications

1. Portable information terminal equipment
2. Personal computers
3. Printers

■ Outline Dimensions

(Unit : mm)

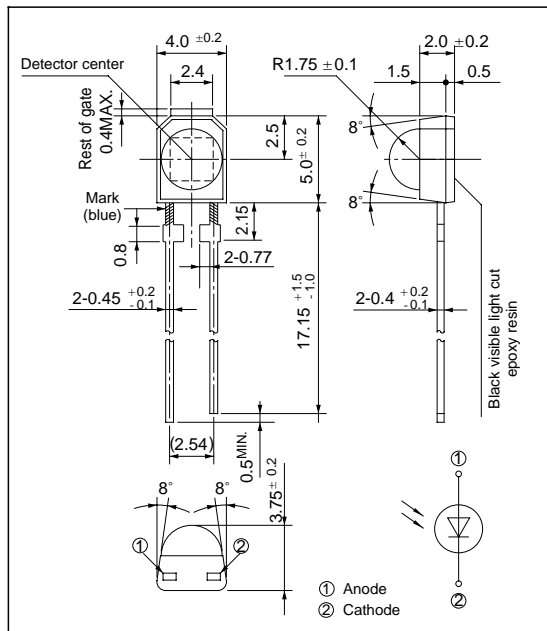

■ Absolute Maximum Ratings

(Ta=25°C)

Parameter	Symbol	Rating	Unit
Reverse voltage	V_R	32	V
Power dissipation	P	150	mW
Operating temperature	T_{opr}	- 25 to + 85	°C
Storage temperature	T_{stg}	- 40 to + 100	°C
*1 Soldering temperature	T_{sol}	260	°C

*1 For 5 seconds at the position of 2.15 mm from bottom face of resin package

■ Electro-optical Characteristics

(Ta=25 °C)

Parameter	Symbol	Conditions	MIN.	TYP.	MAX.	Unit
Shortcircuit current	I_{SC}	$E_v^{*2} = 100 \text{ lx}$	4.5	5.4	8.1	μA
Dark current	I_d	$V_R = 10\text{V}, E_v = 0$	-	-	10	nA
Forward voltage	V_F	$I_F = 1\text{mA}$	-	-	1	V
Terminal capacitance	C_t	$V_R = 3\text{V}, f = 1\text{MHz}$	-	20	35	pF
Peak sensitivity wavelength	λ_p	-	-	960	-	nm
Half intensity angle	$\Delta\theta$	-	-	± 45	-	°
Response time	t_r, t_f	$R_L = 1\text{k}\Omega, V_R = 10\text{V}$	-	200	-	ns

*2 E_v : Illuminance by CIE standard light source A (tungsten lamp)

Fig. 1 Power Dissipation vs. Ambient Temperature

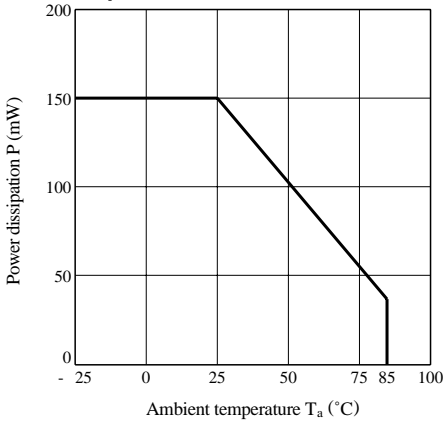

Fig. 2 Spectral Sensitivity

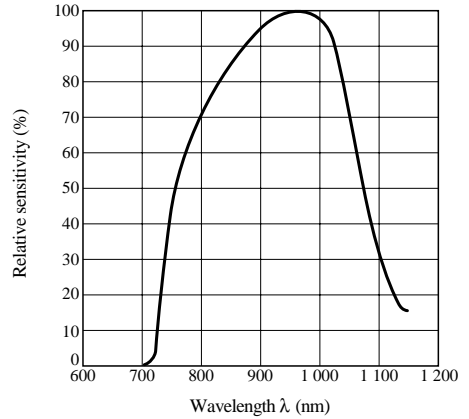

Fig. 3 Shortcircuit Current vs. Illuminance

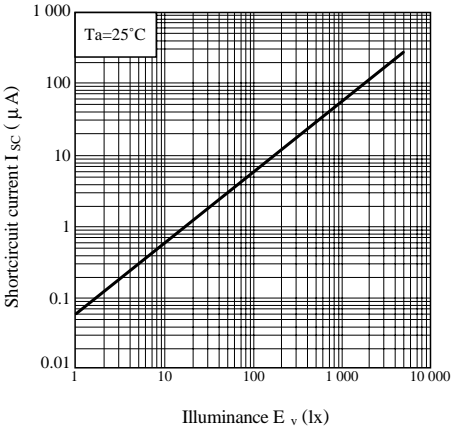

Fig. 4 Dark Current vs. Ambient Temperature

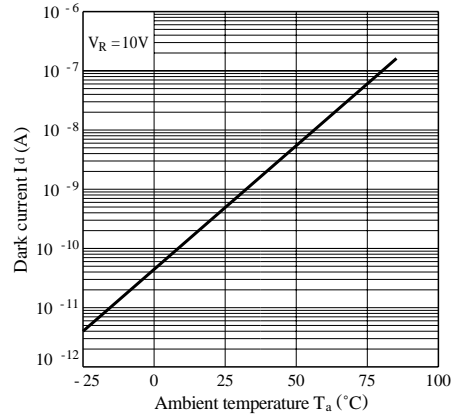

Fig. 5 Dark Current vs. Reverse Voltage

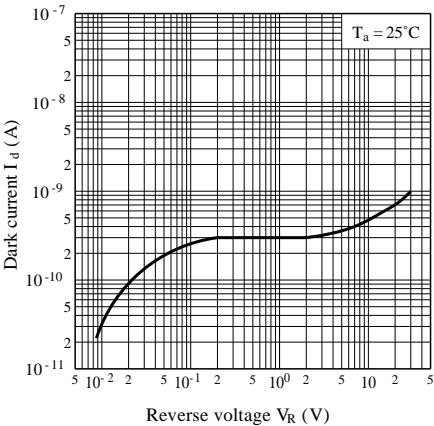

Fig. 6 Terminal Capacitance vs. Reverse Voltage

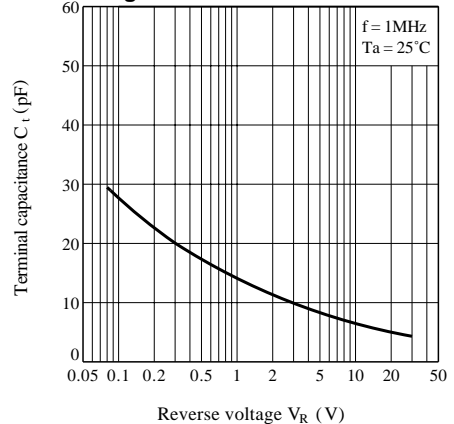

Fig. 7 Relative Output vs. Ambient Temperature (Detector : GL537/GL538)

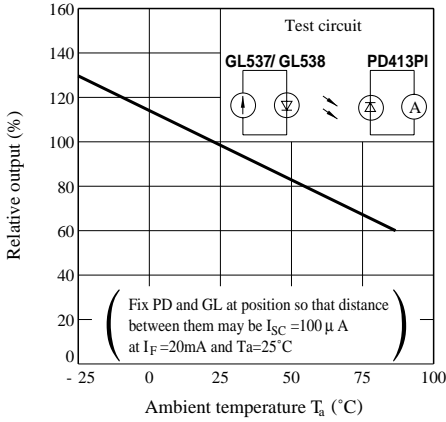

Fig. 8 Radiation Diagram ($T_a = 25^{\circ}\text{C}$)

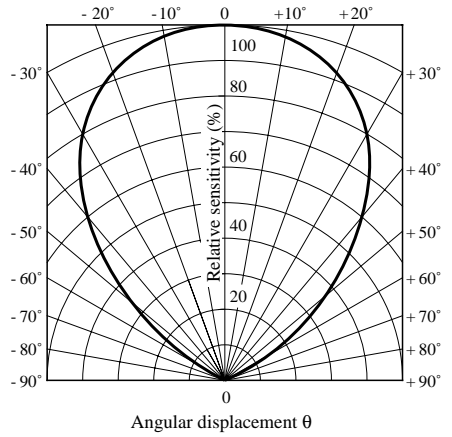

Fig. 9 Relative Output vs. Distance (Detector : GL537/GL538)

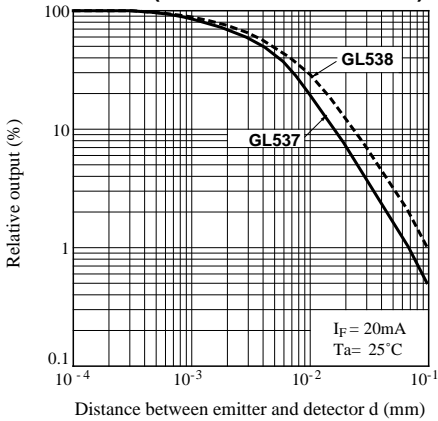
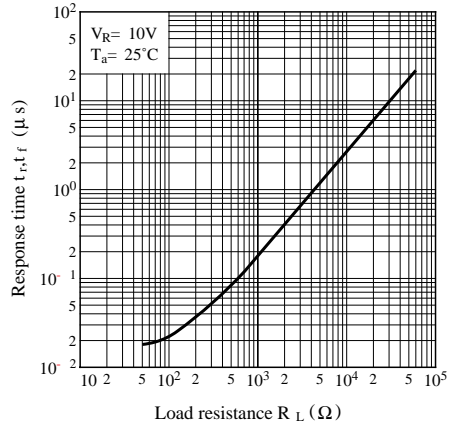
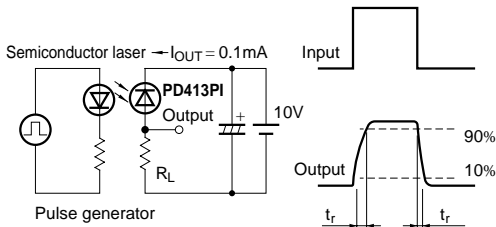

Fig. 10 Response Time vs. Load Resistance



Test Circuit for Response Time



NOTICE

- The circuit application examples in this publication are provided to explain representative applications of SHARP devices and are not intended to guarantee any circuit design or license any intellectual property rights. SHARP takes no responsibility for any problems related to any intellectual property right of a third party resulting from the use of SHARP's devices.
- Contact SHARP in order to obtain the latest device specification sheets before using any SHARP device. SHARP reserves the right to make changes in the specifications, characteristics, data, materials, structure, and other contents described herein at any time without notice in order to improve design or reliability. Manufacturing locations are also subject to change without notice.
- Observe the following points when using any devices in this publication. SHARP takes no responsibility for damage caused by improper use of the devices which does not meet the conditions and absolute maximum ratings to be used specified in the relevant specification sheet nor meet the following conditions:
 - (i) The devices in this publication are designed for use in general electronic equipment designs such as:
 - Personal computers
 - Office automation equipment
 - Telecommunication equipment [terminal]
 - Test and measurement equipment
 - Industrial control
 - Audio visual equipment
 - Consumer electronics
 - (ii) Measures such as fail-safe function and redundant design should be taken to ensure reliability and safety when SHARP devices are used for or in connection with equipment that requires higher reliability such as:
 - Transportation control and safety equipment (i.e., aircraft, trains, automobiles, etc.)
 - Traffic signals
 - Gas leakage sensor breakers
 - Alarm equipment
 - Various safety devices, etc.
 - (iii) SHARP devices shall not be used for or in connection with equipment that requires an extremely high level of reliability and safety such as:
 - Space applications
 - Telecommunication equipment [trunk lines]
 - Nuclear power control equipment
 - Medical and other life support equipment (e.g., scuba).
- Contact a SHARP representative in advance when intending to use SHARP devices for any "specific" applications other than those recommended by SHARP or when it is unclear which category mentioned above controls the intended use.
- If the SHARP devices listed in this publication fall within the scope of strategic products described in the Foreign Exchange and Foreign Trade Control Law of Japan, it is necessary to obtain approval to export such SHARP devices.
- This publication is the proprietary product of SHARP and is copyrighted, with all rights reserved. Under the copyright laws, no part of this publication may be reproduced or transmitted in any form or by any means, electronic or mechanical, for any purpose, in whole or in part, without the express written permission of SHARP. Express written permission is also required before any use of this publication may be made by a third party.
- Contact and consult with a SHARP representative if there are any questions about the contents of this publication.