

**φ80 μm InGaAs PIN-PD COAXIAL MODULE  
 FOR 622 Mb/s, 156 Mb/s FIBEROPTIC COMMUNICATIONS  
 AND EDFA MONITOR**

**DESCRIPTION**

The NR7800 Series is an InGaAs PIN photo diode (PIN-PD) coaxial module with optical fiber pigtail. This module is designed for long wavelength optical communication systems and ideal as a receiver for Synchronous Digital Hierarchy (SDH) system, STM-4 and STM-1, ITU-T recommendations.

**FEATURES**

- Small dark current  $I_D = 0.1 \text{ nA}$
- High sensitivity  $S = 0.89 \text{ A/W @ } \lambda = 1\,310 \text{ nm}$   
 $S = 0.94 \text{ A/W @ } \lambda = 1\,550 \text{ nm}$
- Low operating voltage  $V_R = 5 \text{ V}$
- ★ • Coaxial module with SMF or GI-50 fiber
- ★ • With SC connector : standard, FC connector : option  
(Refer to **ORDERING INFORMATION**)

The information in this document is subject to change without notice. Before using this document, please confirm that this is the latest version.  
 Not all devices/types available in every country. Please check with local NEC representative for availability and additional information.

★ PACKAGE DIMENSIONS (UNIT: mm)

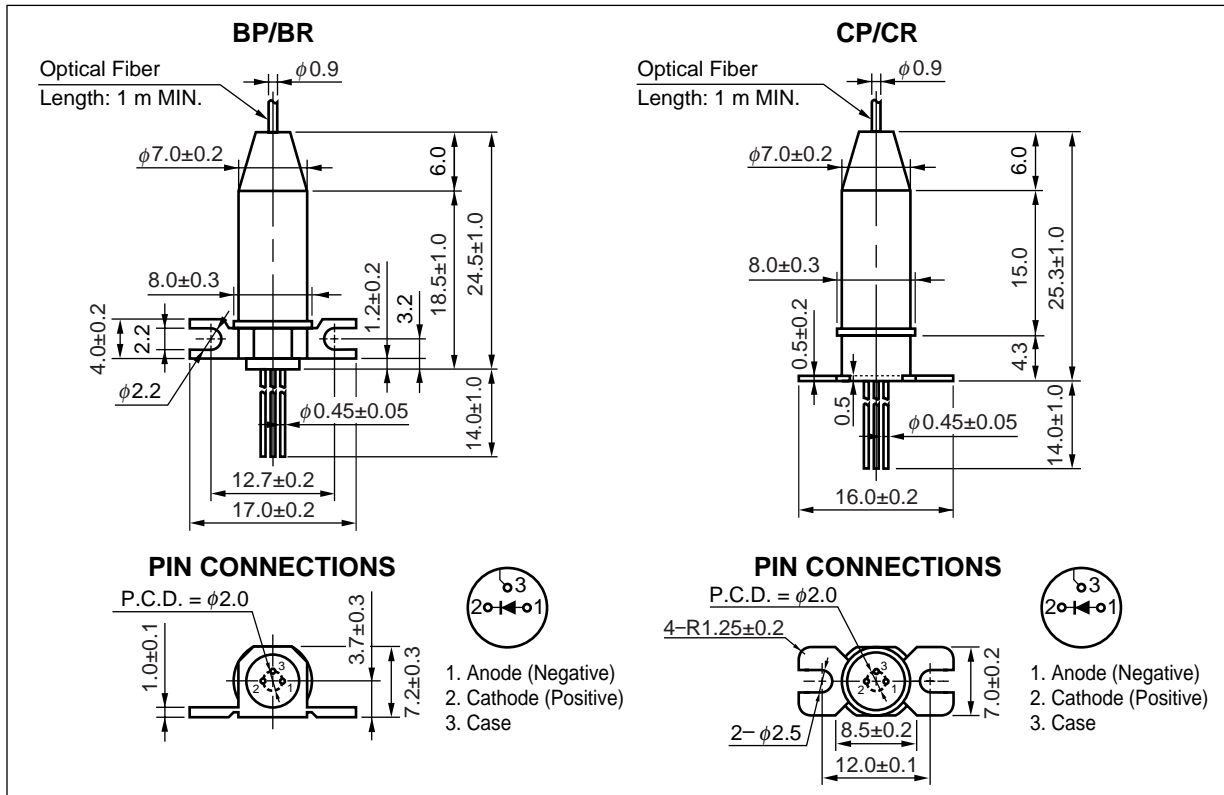

★ OPTICAL FIBER CHARACTERISTICS

| Parameter                           | Specification  |               | Unit          |
|-------------------------------------|----------------|---------------|---------------|
|                                     | SMF            | GI-50 Fiber   |               |
| Mode Field Diameter                 | $9.5 \pm 1$    | —             | $\mu\text{m}$ |
| Core Diameter                       | —              | $50 \pm 3$    | $\mu\text{m}$ |
| Cladding Diameter                   | $125 \pm 2$    | $125 \pm 2$   | $\mu\text{m}$ |
| Maximum Cladding Noncircularity     | 2              | 2             | %             |
| Maximum Core/Cladding Concentricity | 1.6            | 4.0           | %             |
| Outer Diameter                      | $0.9 \pm 0.1$  | $0.9 \pm 0.1$ | mm            |
| Cut-off Wavelength                  | 1 100 to 1 270 | —             | nm            |
| Minimum Fiber Bending Radius        | 30             | 30            | mm            |
| Fiber Length                        | 1 000 MIN.     | 1 000 MIN.    | mm            |
| Flammability                        | UL1581 VW-1    |               |               |

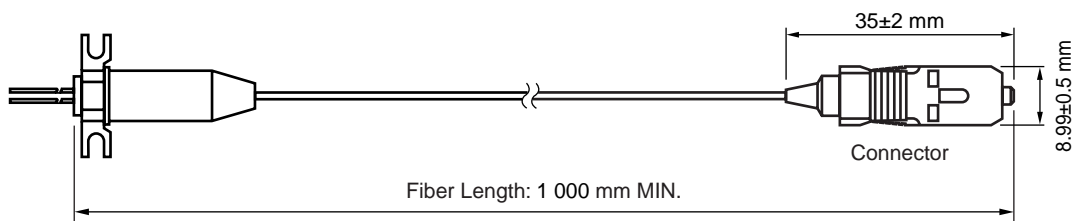

★ **ORDERING INFORMATION**

| Part Number | Flange Type           | Fiber Type  | Available Connector <sup>*1</sup> |
|-------------|-----------------------|-------------|-----------------------------------|
| NR7800BP-BC | Flat Mount Flange     | SMF         | With FC-UPC Connector             |
| NR7800BP-CC |                       |             | With SC-UPC Connector             |
| NR7800BR-BB |                       | GI-50 Fiber | With FC-SPC Connector             |
| NR7800BR-CB |                       |             | With SC-SPC Connector             |
| NR7800CP-BC | Vertical Mount Flange | SMF         | With FC-UPC Connector             |
| NR7800CP-CC |                       |             | With SC-UPC Connector             |
| NR7800CR-BB |                       | GI-50 Fiber | With FC-SPC Connector             |
| NR7800CR-CB |                       |             | With SC-SPC Connector             |

\*1 SC Connector : standard  
 FC Connector : option

**ABSOLUTE MAXIMUM RATINGS**

| Parameter                         | Symbol    | Ratings       | Unit |
|-----------------------------------|-----------|---------------|------|
| Reverse Voltage                   | $V_R$     | 20            | V    |
| Forward Current                   | $I_F$     | 10            | mA   |
| Optical Input Power               | $P_{in}$  | 8             | mW   |
| Operating Case Temperature        | $T_c$     | -40 to +85    | °C   |
| Storage Temperature               | $T_{stg}$ | -40 to +85    | °C   |
| Lead Soldering Temperature        | $T_{sld}$ | 260 (10 sec.) | °C   |
| Relative Humidity (noncondensing) | RH        | 85            | %    |

**ELECTRO-OPTICAL CHARACTERISTICS (T<sub>c</sub> = -40 to +85 °C, unless otherwise specified)**

| Parameter                              | Symbol          | Conditions  | MIN. | TYP. | MAX. | Unit |
|--|-----------------|---|------|------|------|------|
| Dark Current                           | I <sub>D</sub>  | V <sub>R</sub> = 5 V, T <sub>C</sub> = 25 °C                        |      | 0.1  | 1.0  | nA   |
|  |                 | V <sub>R</sub> = 5 V  |      |      | 20   |      |
| Terminal Capacitance                   | C <sub>t</sub>  | V <sub>R</sub> = 5 V, f = 1 MHz, T <sub>C</sub> = 25 °C             |      | 1.0  | 1.5  | pF   |
| Sensitivity                            | S               | V <sub>R</sub> = 5 V, λ = 1 310 nm                                  | 0.78 | 0.89 |      | A/W  |
|  |                 | V <sub>R</sub> = 5 V, λ = 1 550 nm                                  | 0.80 | 0.94 |      |      |
| Temperature Dependence of Sensitivity  | ΔS <sub>t</sub> | V <sub>R</sub> = 5 V, λ = 1 550 nm                                  | -5   |      | 5    | %    |
| Polarization Dependence of Sensitivity | ΔS <sub>p</sub> | V <sub>R</sub> = 5 V, λ = 1 550 nm, T <sub>C</sub> = 25 °C          | -2.5 |      | 2.5  | %    |
| Wavelength Dependence of Sensitivity   | ΔS <sub>w</sub> | V <sub>R</sub> = 5 V, λ = 1 520 to 1 560 nm, T <sub>C</sub> = 25 °C | -2.5 |      | 2.5  | %    |
| Cut-off Frequency                      | f <sub>c</sub>  | V <sub>R</sub> = 5 V, T <sub>C</sub> = 25 °C                        | 2.5  |      |      | GHz  |
| ★ Optical Return Loss                  | ORL             | SMF   | 30   |      |      | dB   |
|  |                 | GI-50 Fiber   | 28   |      |      |      |

TYPICAL CHARACTERISTICS (T<sub>c</sub> = 25 °C, unless otherwise specified)

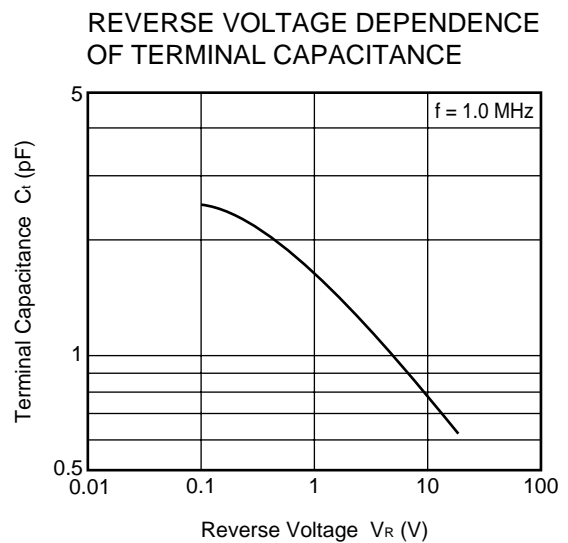
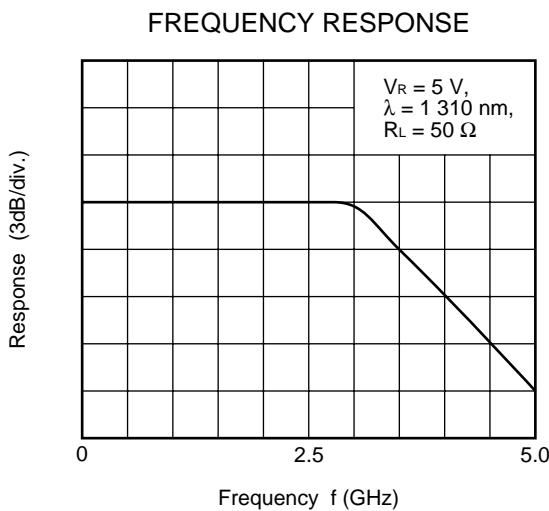
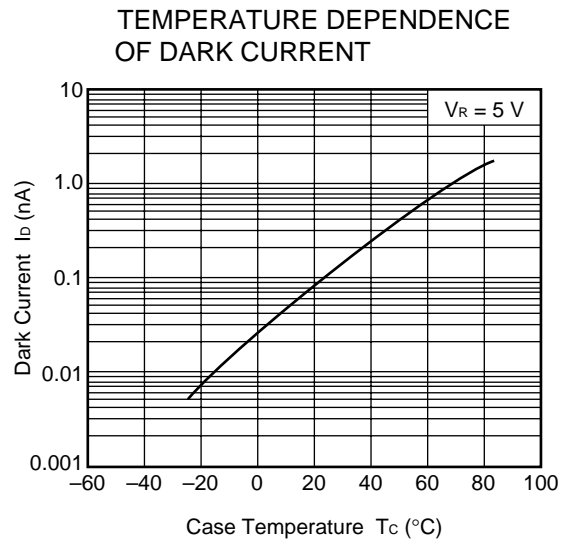
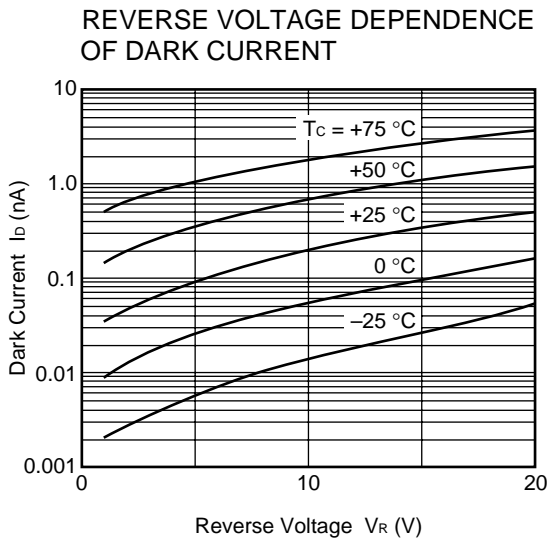
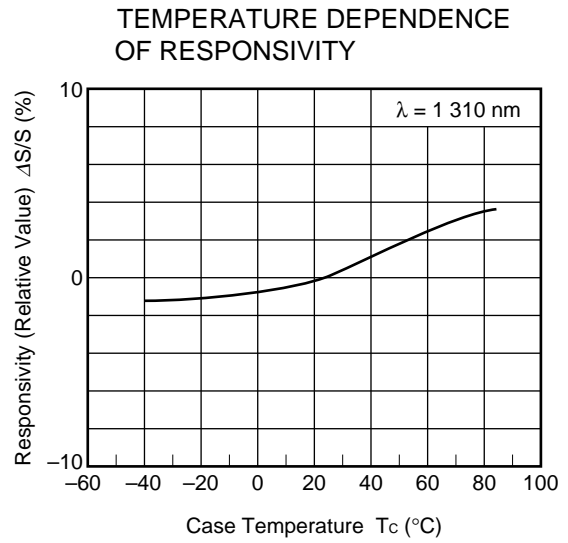
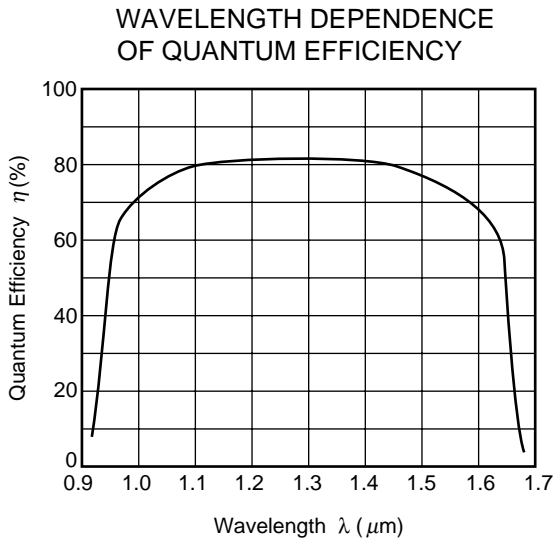

**Remark** The graphs indicate nominal characteristics.

★ InGaAs APD/PD FAMILY

| Part Number                | Absolute Maximum Ratings |                          | Electro-Optical Characteristics (T <sub>c</sub> = 25 °C) |                        |                         |            |            |                       | Applications                | Package                                 |
|----------------------------|--------------------------|--------------------------|--|------------------------|-------------------------|------------|------------|-----------------------|-----------------------------|---|
|                            | T <sub>c</sub><br>(°C)   | T <sub>stg</sub><br>(°C) | Detect-<br>ing Area<br>Size<br>(μm)                      | I <sub>b</sub><br>(nA) | f <sub>c</sub><br>(GHz) | S<br>(A/W) |            | V <sub>R</sub><br>(V) |                             |   |
|                            |                          |                          |  | TYP.                   | MIN.                    | TYP.       | @λ<br>(nm) |                       |                             |   |
| NR4500BP-CC<br>NR4500CP-CC | 0 to +70                 | -40 to +85               | φ50  | -                      | 2.5 <sup>*1</sup>       | 0.94       | 1 310      | 0.9V <sub>BR</sub>    | 2.5 Gb/s:<br>STM-16         | Coaxial APD with<br>an Internal pre-amp |
| NR7500 Series              | -40 to +85               | -40 to +85               | φ50  | 0.1                    | 2.5                     | 0.89       | 1 310      | 5                     | 2.5 Gb/s:<br>STM-16         | Coaxial PD                              |
| NR7800 Series              | -40 to +85               | -40 to +85               | φ80  | 0.1                    | 2.5                     | 0.89       | 1 310      | 5                     | ≤ 622 Mb/s:<br>STM-4, STM-1 | Coaxial PD                              |
| NR8500 Series              | -40 to +85               | -40 to +85               | φ50  | 7                      | 1                       | 0.94       | 1 310      | 0.9V <sub>BR</sub>    | ≤ 622 Mb/s:<br>STM-4, STM-1 | Coaxial APD                             |
| NR8501 Series              | -40 to +85               | -40 to +85               | φ50  | 7                      | 2.5                     | 0.94       | 1 310      | 0.9V <sub>BR</sub>    | 2.5 Gb/s:<br>STM-16         | Coaxial APD                             |

\*1  $\bar{P}_{Low}$  and  $\bar{P}_{High}$  are specified at 2.5 Gb/s

★ REFERENCE

| Document Name   | Document No. |
|---|--------------|
| Optical semiconductor devices for fiberoptic communications Selection Guide | P12480E      |
| Opto-Electronics Devices Pamphlet   | P13623E      |
| Opto-Electronics Devices (CD-ROM)   | P12944X      |
| NEC semiconductor device reliability/quality control system                 | C11159E      |
| Quality grades on NEC semiconductor devices                                 | C11531E      |
| SEMICONDUCTOR SELECTION GUIDE –Products and Packages–                       | X13769E      |

**SAFETY INFORMATION ON THIS PRODUCT**

|                                     |   |
|-------------------------------------|---|
| <p><b>Caution</b> GaAs Products</p> | <p>The product contains gallium arsenide, GaAs.<br/>GaAs vapor and powder are hazardous to human health if inhaled or ingested.</p> <ul style="list-style-type: none"> <li>• Do not destroy or burn the product.</li> <li>• Do not cut or cleave off any part of the product.</li> <li>• Do not crush or chemically dissolve the product.</li> <li>• Do not put the product in the mouth.</li> </ul> <p>Follow related laws and ordinances for disposal. The product should be excluded from general industrial waste or household garbage.</p> |
| <p><b>Caution</b> Optical Fiber</p> | <p>A glass-fiber is attached on the product. Handle with care.</p> <ul style="list-style-type: none"> <li>• When the fiber is broken or damaged, handle carefully to avoid injury from the damaged part or fragments.</li> </ul>  |

The export of this product from Japan is prohibited without governmental license. To export or re-export this product from a country other than Japan may also be prohibited without a license from that country. Please call an NEC sales representative.

- **The information in this document is current as of May, 2001. The information is subject to change without notice. For actual design-in, refer to the latest publications of NEC's data sheets or data books, etc., for the most up-to-date specifications of NEC semiconductor products. Not all products and/or types are available in every country. Please check with an NEC sales representative for availability and additional information.**
  - No part of this document may be copied or reproduced in any form or by any means without prior written consent of NEC. NEC assumes no responsibility for any errors that may appear in this document.
  - NEC does not assume any liability for infringement of patents, copyrights or other intellectual property rights of third parties by or arising from the use of NEC semiconductor products listed in this document or any other liability arising from the use of such products. No license, express, implied or otherwise, is granted under any patents, copyrights or other intellectual property rights of NEC or others.
  - Descriptions of circuits, software and other related information in this document are provided for illustrative purposes in semiconductor product operation and application examples. The incorporation of these circuits, software and information in the design of customer's equipment shall be done under the full responsibility of customer. NEC assumes no responsibility for any losses incurred by customers or third parties arising from the use of these circuits, software and information.
  - While NEC endeavours to enhance the quality, reliability and safety of NEC semiconductor products, customers agree and acknowledge that the possibility of defects thereof cannot be eliminated entirely. To minimize risks of damage to property or injury (including death) to persons arising from defects in NEC semiconductor products, customers must incorporate sufficient safety measures in their design, such as redundancy, fire-containment, and anti-failure features.
  - NEC semiconductor products are classified into the following three quality grades:  
"Standard", "Special" and "Specific". The "Specific" quality grade applies only to semiconductor products developed based on a customer-designated "quality assurance program" for a specific application. The recommended applications of a semiconductor product depend on its quality grade, as indicated below. Customers must check the quality grade of each semiconductor product before using it in a particular application.  
"Standard": Computers, office equipment, communications equipment, test and measurement equipment, audio and visual equipment, home electronic appliances, machine tools, personal electronic equipment and industrial robots  
"Special": Transportation equipment (automobiles, trains, ships, etc.), traffic control systems, anti-disaster systems, anti-crime systems, safety equipment and medical equipment (not specifically designed for life support)  
"Specific": Aircraft, aerospace equipment, submersible repeaters, nuclear reactor control systems, life support systems and medical equipment for life support, etc.
- The quality grade of NEC semiconductor products is "Standard" unless otherwise expressly specified in NEC's data sheets or data books, etc. If customers wish to use NEC semiconductor products in applications not intended by NEC, they must contact an NEC sales representative in advance to determine NEC's willingness to support a given application.
- (Note)
- (1) "NEC" as used in this statement means NEC Corporation and also includes its majority-owned subsidiaries.
  - (2) "NEC semiconductor products" means any semiconductor product developed or manufactured by or for NEC (as defined above).