

- Gallium-Arsenide-Diode Infrared Source
- Source Is Optically Coupled to Silicon npn Phototransistor
- Choice of One, Two, or Four Channels
- Choice of Three Current-Transfer Ratios
- High-Voltage Electrical Isolation 3.535 kV Peak (2.5 kV rms)
- Plastic Dual-In-Line Packages
- UL Listed — File #E65085

description

These optocouplers consist of one gallium-arsenide light-emitting diode and one silicon npn phototransistor per channel. The TIL191 has a single channel in a 4-pin package, the TIL192 has two channels in an 8-package, and the TIL193 has four channels in a 16-pin package. The standard devices, TIL191, TIL192, and TIL193, are tested for a current-transfer ratio of 20% minimum. Devices selected for a current-transfer ratio of 50% and 100% minimum are designated with the suffix A and B respectively.

schematic diagrams

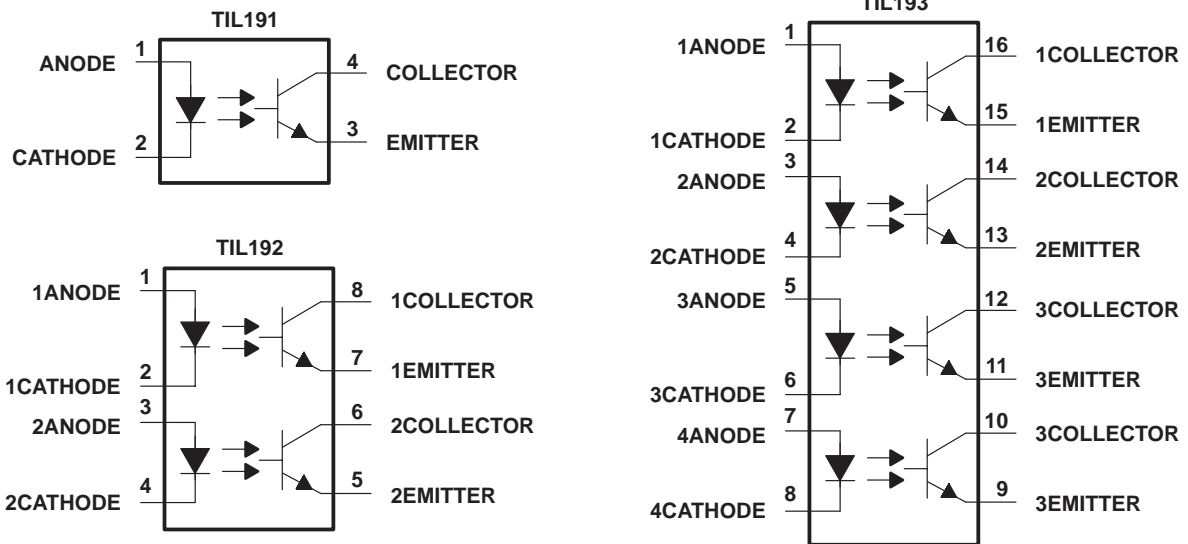

absolute maximum ratings at 25°C free-air (unless otherwise noted)†

Input-to-output voltage (see Note 1)	±3.535 kV peak or dc (±2.5 kV rms)
Collector-emitter voltage (see Note 2)	35 V
Emitter-collector voltage	7 V
Input diode reverse voltage	5 V
Input diode continuous forward current at (or below) 25°C free-air temperature (see Note 3)	50 mA
Continuous total power dissipation at (or below) 25°C free-air temperature:	
Phototransistor (see Note 4)	150 mW
Input diode plus phototransistor per channel (see Note 5)	200 mW
Storage temperature range, T _{stg}	–55°C to 125°C
Lead temperature 1,6 mm (1/16 inch) from case for 10 seconds	260°C

† Stresses beyond those listed under “absolute maximum ratings” may cause permanent damage to the device. These are stress ratings only, and functional operation of the device at these or any other conditions beyond those indicated under “recommended operating conditions” is not implied. Exposure to absolute-maximum-rated conditions for extended periods may affect device reliability.

- NOTES:
1. This rating applies for sine-wave operation at 50 Hz or 60 Hz. This capability is verified by testing in accordance with UL requirements.
 2. This value applies when the base-emitter diode is open circuited.
 3. Derate linearly to 100°C free-air temperature at the rate of 0.67 mA/°C.
 4. Derate linearly to 100°C free-air temperature at the rate of 2 mW/°C.
 5. Derate linearly to 100°C free-air temperature at the rate of 2.67 mW/°C.

TIL191, TIL192, TIL193, TIL191A, TIL192A, TIL193A TIL191B, TIL192B, TIL193B OPTOCOUPLEDERS

SOES026B – APRIL 1989 – REVISED APRIL 1998

electrical characteristics 25°C free-air temperature range (unless otherwise noted)

PARAMETER		TEST CONDITIONS	MIN	TYP	MAX	UNIT
$V_{(BR)CEO}$	Collector-emitter breakdown voltage	$I_C = 0.5 \text{ mA}$, $I_F = 0$	35			V
$V_{(BR)ECO}$	Emitter-collector breakdown voltage	$I_C = 100 \mu\text{A}$, $I_F = 0$	7			V
I_R	Input diode static reverse current	$V_R = 5 \text{ V}$			10	μA
$I_{C(off)}$	Off-state collector current	$V_{CE} = 24 \text{ V}$, $I_F = 0$			100	nA
CTR	Current transfer ratio	TIL191, TIL192, TIL193		20%		
		TIL191A, TIL192A, TIL193A	$I_F = 5 \text{ mA}$, $V_{CE} = 5 \text{ V}$	50%		
		TIL191B, TIL192B, TIL193B		100%		
V_F	Input diode static forward voltage	$I_F = 20 \text{ mA}$			1.4	V
$V_{CE(sat)}$	Collector-emitter saturation voltage	$I_F = 5 \text{ mA}$, $I_C = 1 \text{ mA}$			0.4	V
C_{io}	Input-to-output capacitance	$V_{in-out} = 0 \text{ mA}$, $f = 1 \text{ MHz}$, See Note 6		1		pF
r_{io}	Input-to-output internal resistance	$V_{in-out} = \pm 1 \text{ mA}$, See Note 6		10^{11}		Ω

NOTE 6: These parameters are measured between all input diode leads shorted together and all phototransistor leads shorted together.

switching characteristics at 25°C free-air temperature

PARAMETER		TEST CONDITIONS	MIN	TYP	MAX	UNIT
t_r	Rise time	$V_{CC} = 5 \text{ V}$, $I_{C(on)} = 2 \text{ mA}$, $R_L = 100 \Omega$, See Figure 1		6		μs
t_f	Fall time			6		

PARAMETER MEASUREMENT INFORMATION

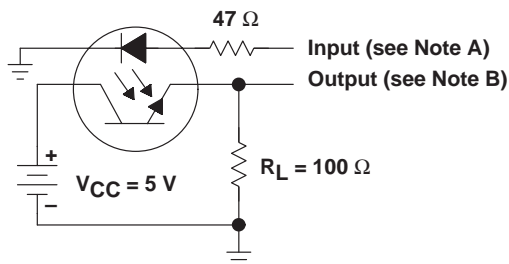

TEST CIRCUIT

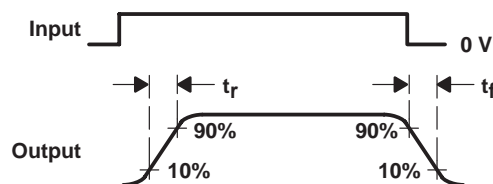

NOTE C. Adjust amplitude of input pulse for $I_{C(on)} = 2 \text{ mA}$

VOLTAGE WAVEFORMS

- NOTES: A. The input waveform is supplied by a generator with the following characteristics: $Z_{OUT} = 50 \Omega$, $t_r \leq 15 \text{ ns}$, duty cycle $\approx 1\%$, $t_w = 100 \mu\text{s}$.
B. The output waveform is monitored on an oscilloscope with the following characteristic: $t_r \leq 12 \text{ ns}$, $R_{in} \geq 1 \text{ M}\Omega$, $C_{in} \leq 20 \text{ pF}$.

Figure 1. Switching Times

TYPICAL CHARACTERISTICS

**FORWARD CURRENT
 vs
 FORWARD VOLTAGE**

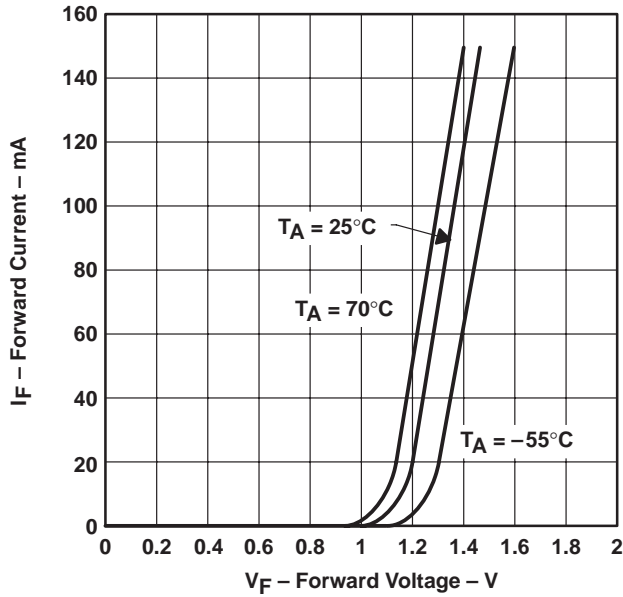

Figure 2

**TIL191, TIL192, TIL193
 COLLECTOR CURRENT
 vs
 COLLECTOR-EMITTER VOLTAGE**

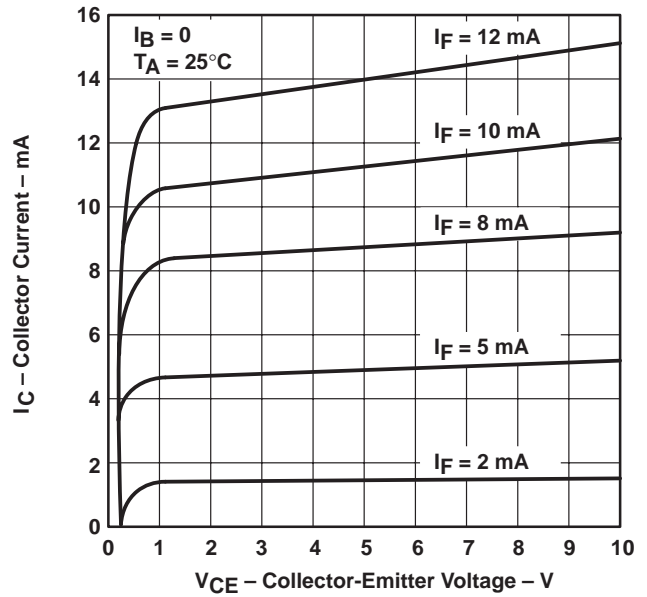

Figure 3

**ON-STATE COLLECTOR CURRENT (NORMALIZED)
 vs
 INPUT DIODE FORWARD CURRENT**

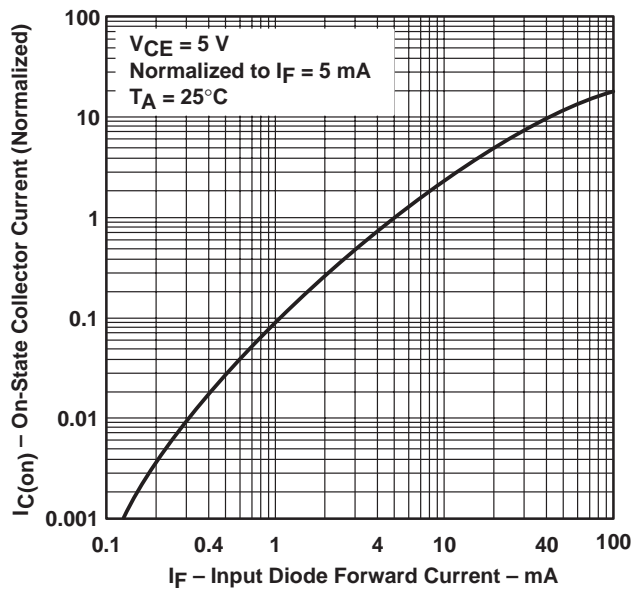

Figure 4

**ON-STATE COLLECTOR CURRENT
 (RELATIVE TO VALUE AT 25°C)
 vs
 FREE-AIR TEMPERATURE**

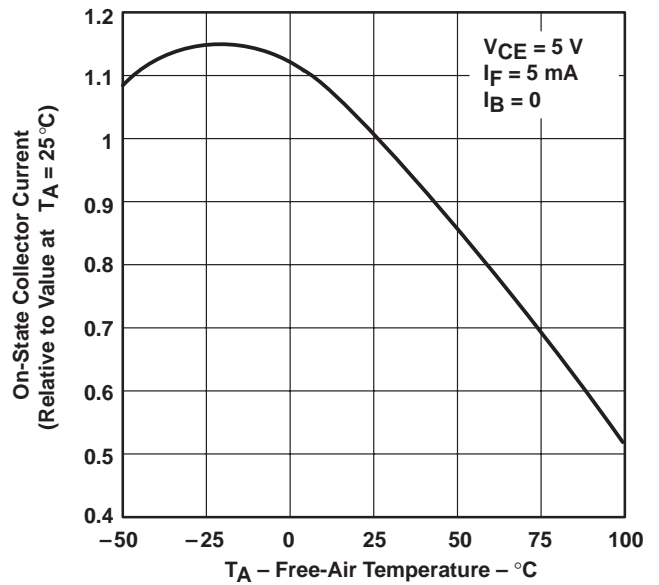

Figure 5

TYPICAL CHARACTERISTICS

COLLECTOR-EMITTER SATURATION VOLTAGE
 VS
 FREE-AIR TEMPERATURE

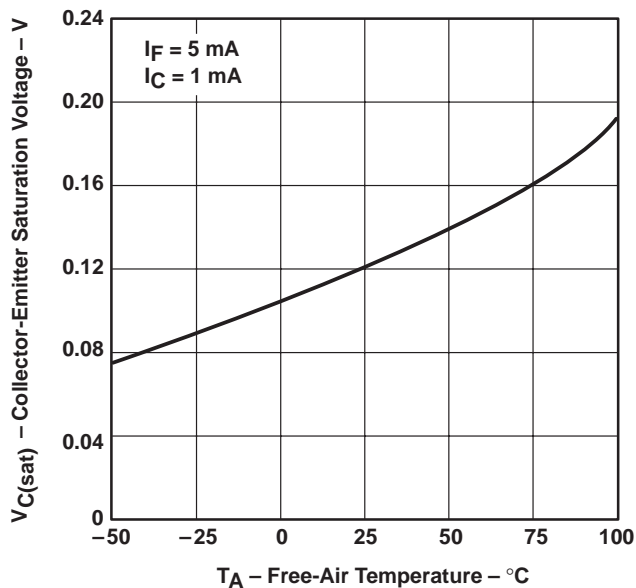

Figure 6

APPLICATION INFORMATION

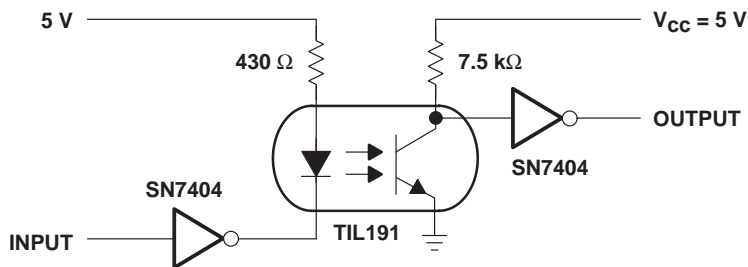
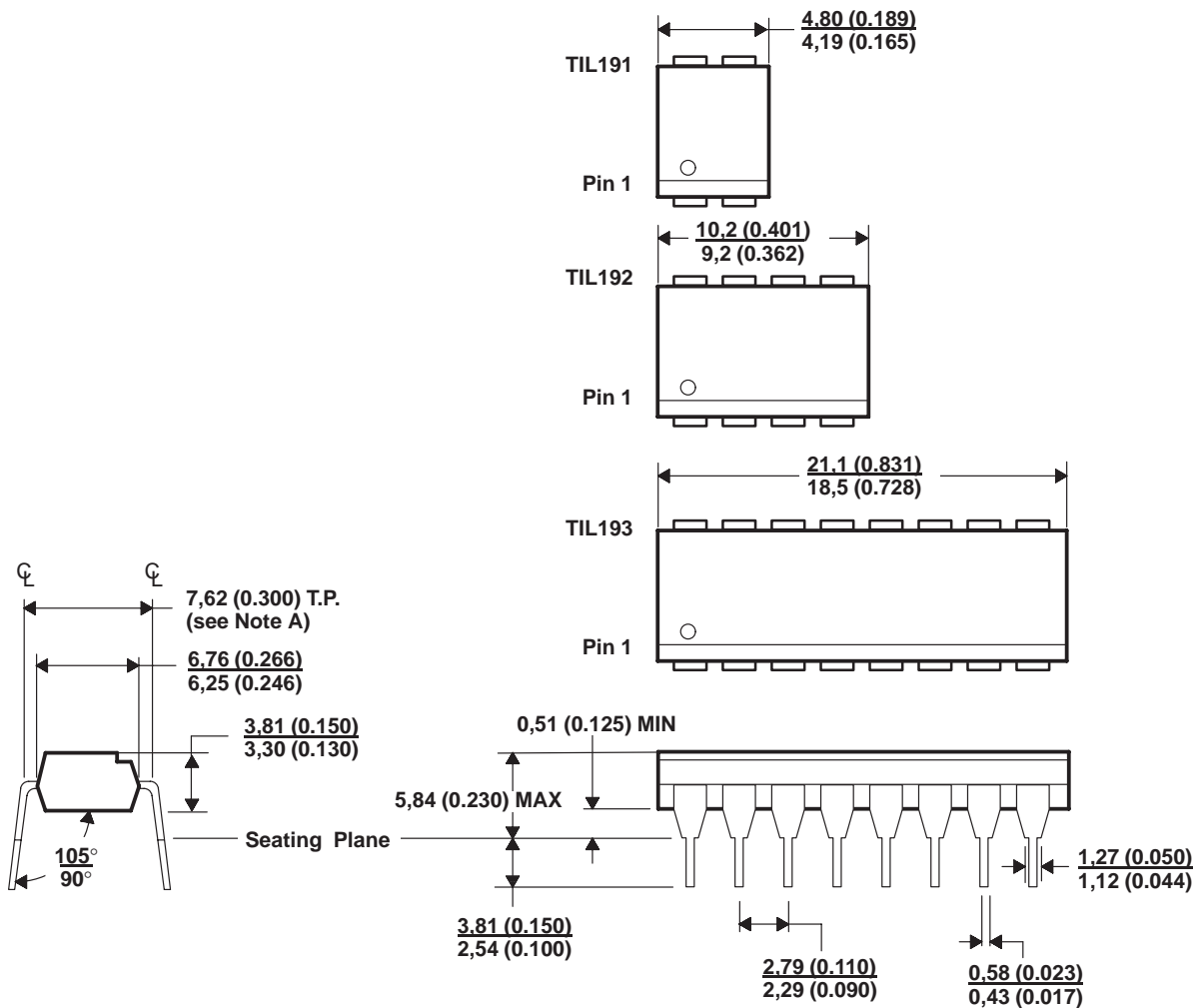

Figure 7

MECHANICAL INFORMATION



- NOTES: A. Each pin centerline is located within 0,25 (0.010) of its true longitudinal position.
 B. All linear dimensions are given in millimeters and parenthetically given in inches.

Figure 8. Mechanical Information

IMPORTANT NOTICE

Texas Instruments (TI) reserves the right to make changes to its products or to discontinue any semiconductor product or service without notice, and advises its customers to obtain the latest version of relevant information to verify, before placing orders, that the information being relied on is current and complete.

TI warrants performance of its semiconductor products and related software to the specifications applicable at the time of sale in accordance with TI's standard warranty. Testing and other quality control techniques are utilized to the extent TI deems necessary to support this warranty. Specific testing of all parameters of each device is not necessarily performed, except those mandated by government requirements.

Certain applications using semiconductor products may involve potential risks of death, personal injury, or severe property or environmental damage ("Critical Applications").

TI SEMICONDUCTOR PRODUCTS ARE NOT DESIGNED, INTENDED, AUTHORIZED, OR WARRANTED TO BE SUITABLE FOR USE IN LIFE-SUPPORT APPLICATIONS, DEVICES OR SYSTEMS OR OTHER CRITICAL APPLICATIONS.

Inclusion of TI products in such applications is understood to be fully at the risk of the customer. Use of TI products in such applications requires the written approval of an appropriate TI officer. Questions concerning potential risk applications should be directed to TI through a local SC sales office.

In order to minimize risks associated with the customer's applications, adequate design and operating safeguards should be provided by the customer to minimize inherent or procedural hazards.

TI assumes no liability for applications assistance, customer product design, software performance, or infringement of patents or services described herein. Nor does TI warrant or represent that any license, either express or implied, is granted under any patent right, copyright, mask work right, or other intellectual property right of TI covering or relating to any combination, machine, or process in which such semiconductor products or services might be or are used.