

TLP751

Digital Logic Ground Isolation
 Line Receiver
 Microprocessor System Interfaces
 Switching Power Supply Feedback Control
 Analog Signal Isolation

The TOSHIBA TLP751 consists of GaAlAs high-output light emitting diode and a high speed detector of one chip photo diode-transistor. This unit is 8-lead DIP.

TLP751 has internal base connection. This base pin should be used for analog application or enable operation. If base pin is open, output signal will be noisy by environmental condition. For this case, TLP750 is suitable.

- Switching speed: $t_{pHL} = 0.3\mu s$ (typ.)
 $t_{pLH} = 0.5\mu s$ (typ.) ($R_L = 1.9k\Omega$)
- TTL compatible
- UL recognized: UL1577, file no. E67349
- BSI approved: BS EN60065: 1994,
 Certificate no. 7613
 BS EN60950: 1992,
 Certificate no. 7614
- Isolation voltage: 5000Vrms(min.)
- Option(D4)type
 VDE approved: DIN VDE0884 / 06.92,
 Certificate no. 68384
 Maximum operating insulation voltage: 890V_{PK}
 Highest permissible over voltage: 8000V_{PK}

(Note) When a VDE0884 approved type is needed, please designate the "Option(D4)"

- Creepage distance: 6.4mm(min.)
 Clearance: 6.4mm(min.)
 Insulation thickness: 0.4mm(min.)

Unit in mm

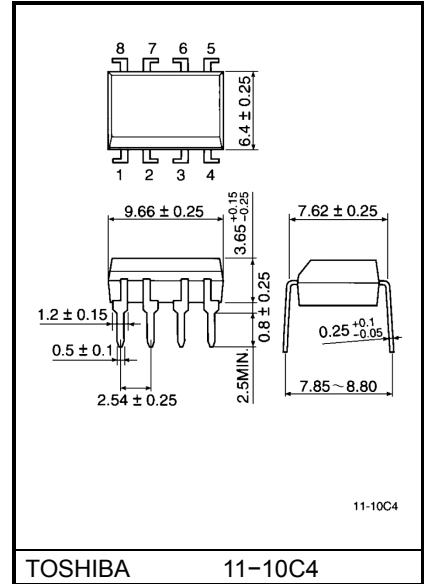

Weight: 0.54g

Pin Configuration(top view)

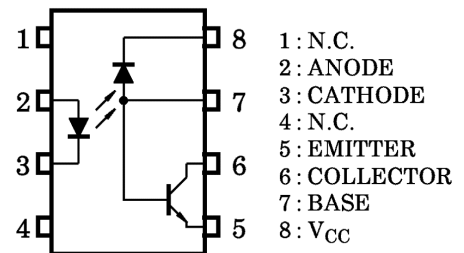

Schematic

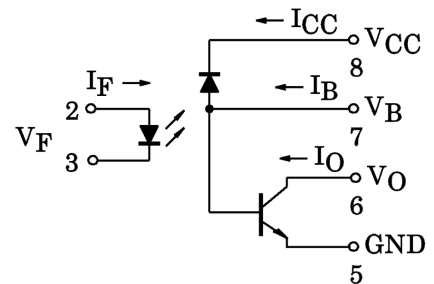

Maximum Ratings (Ta = 25°C)

| Characteristic | | Symbol | Rating | Unit |
|--|---|-----------|---------|------|
| LED | Forward current (Note 1) | I_F | 25 | mA |
| | Pulse forward current (Note 2) | I_{FP} | 50 | mA |
| | Peak transient forward current (Note 3) | I_{FPT} | 1 | A |
| | Reverse voltage | V_R | 5 | V |
| | Diode power dissipation (Note 4) | P_D | 45 | mW |
| Detector | Output current | I_O | 8 | mA |
| | Peak output current | I_{OP} | 16 | mA |
| | Output voltage | V_O | -0.5~15 | V |
| | Supply voltage | V_{CC} | -0.5~15 | V |
| | Base current | I_B | 5 | mA |
| | Output power dissipation (Note 5) | P_O | 100 | mW |
| | Emitter-base reverse voltage | V_{EB} | 5 | V |
| Operating temperature range | | T_{opr} | -55~100 | °C |
| Storage temperature range | | T_{stg} | -55~125 | °C |
| Lead solder temperature(10s) (Note 6) | | T_{sol} | 260 | °C |
| Isolation voltage (AC, 1min., R.H. ≤ 60%) (Note 7) | | BV_S | 5000 | Vrms |

(Note 1) Derate 0.8mA above 70°C

(Note 2) 50% duty cycle, 1ms pulse width.

Derate 1.6mA / °C above 70°C

(Note 3) Pulse width ≤ 1μs, 300pps.

(Note 4) Derate 0.9mW / °C above 70°C

(Note 5) Derate 2mW / °C above 70°C

(Note 6) Soldering portion of lead : up to 2mm from the body of the device.

(Note 7) Device considered a two terminal device: Pins 1,2,3 and 4 shorted together and pins 5,6,7 and 8 shorted together.

Electrical Characteristics (Ta = 25°C)

| Characteristic | | Symbol | Test Condition | Min. | Typ. | Max. | Unit |
|---------------------------|---|---|---|--------------------|-----------|---------------|---------------|
| LED | Forward voltage | V_F | $I_F = 16 \text{ mA}$ | — | 1.65 | 1.85 | V |
| | Forward voltage Temperature coefficient | $\Delta V_F / \Delta T_a$ | $I_F = 16 \text{ mA}$ | — | -2 | — | mV / °C |
| | Reverse current | I_R | $V_R = 5 \text{ V}$ | — | — | 10 | μA |
| | Capacitance between terminal | CT | $V_F = 0, f = 1 \text{ MHz}$ | — | 45 | — | pF |
| Detector | High level output current | $I_{OH(1)}$ | $I_F = 0 \text{ mA}, V_{CC} = V_O = 5.5 \text{ V}$ | — | 3 | 500 | nA |
| | | $I_{OH(2)}$ | $I_F = 0 \text{ mA}, V_{CC} = V_O = 15 \text{ V}$ | — | — | 5 | μA |
| | | I_{OH} | $I_F = 0 \text{ mA}, V_{CC} = V_O = 15 \text{ V}$ $T_a = 70^\circ\text{C}$ | — | — | 50 | |
| High level supply voltage | I_{CCH} | $I_F = 0 \text{ mA}, V_{CC} = 15 \text{ V}$ | — | 0.01 | 1 | μA | |
| Coupled | Current transfer ratio | I_O / I_F | $I_F = 16 \text{ mA}, V_{CC} = 4.5 \text{ V}$ $V_O = 0.4 \text{ V}$ | 10 | 30 | — | % |
| | Low level output voltage | V_{OL} | $I_F = 16 \text{ mA}, V_{CC} = 4.5 \text{ V}$ $I_O = 1.1 \text{ mA}$ | — | — | 0.4 | V |
| | resistance(input-output) | R_S | R.H. $\leq 60\%$, $V_S = 500 \text{ V}_{DC}$ (Note7) | 1×10^{12} | 10^{14} | — | Ω |
| | Capacitance (input-output) | C_S | $V_S = 0, f = 1 \text{ MHz}$ (Note7) | — | 0.8 | — | pF |

Switching Characteristics (Ta = 25°C, VCC = 5V)

| Characteristic | Symbol | Test Circuit | Test Condition | Min. | Typ. | Max. | Unit |
|--|-----------|--------------|--|------|-------|------|-------------------|
| Propagation delay time (H→L) | t_{pHL} | 1 | $I_F = 0 \rightarrow 16 \text{ mA}, V_{CC} = 5 \text{ V}, R_L = 4.1 \text{ k}\Omega$ | — | 0.2 | — | μs |
| Propagation delay time (L→H) | t_{pLH} | | $I_F = 16 \rightarrow 0 \text{ mA}, V_{CC} = 5 \text{ V}, R_L = 4.1 \text{ k}\Omega$ | — | 1.0 | — | μs |
| Common mode transient immunity at logic high output (Note 8) | CM_H | 2 | $I_F = 0 \text{ mA}, V_{CM} = 200 \text{ V}_{p-p}, R_L = 4.1 \text{ k}\Omega$ | — | 400 | — | V / μs |
| Common mode transient immunity at logic low output (Note 8) | CM_L | | $I_F = 16 \text{ mA}, V_{CM} = 200 \text{ V}_{p-p}, R_L = 4.1 \text{ k}\Omega$ | — | -1000 | — | V / μs |

(Note 8) CM_L is the maximum rate of fall of the common mode voltage that can be sustained with the output voltage in the logic low state ($V_O < 0.8V$).

CM_H is the maximum rate of rise of the common mode voltage that can be sustained with the output voltage in the logic high state ($V_O > 2.0V$).

(Note 9) Maximum electrostatic discharge voltage for any pins: 100V ($C = 200pF, R = 0$).

Test Circuit 1 : Switching Time Test Circuit

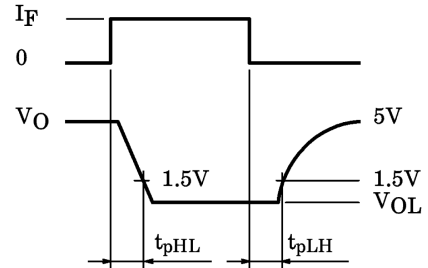
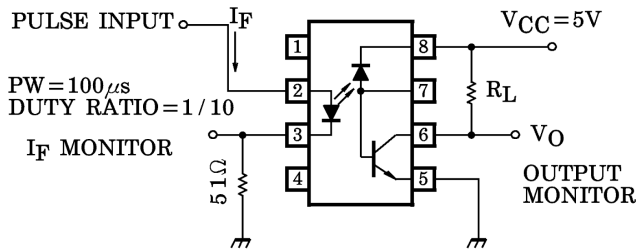

Test Circuit 2 : Common Mode Noise Immunity Test Circuit

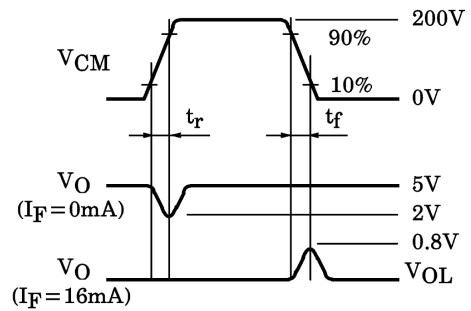
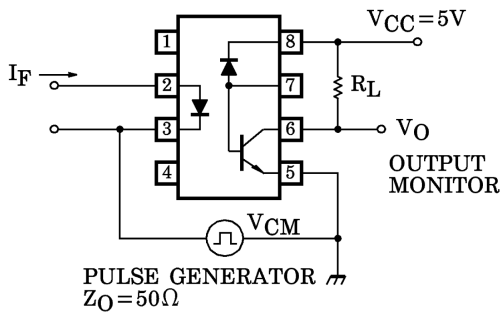

$$CM_H = \frac{160(V)}{t_r(\mu s)}, CM_L = \frac{160(V)}{t_f(\mu s)}$$

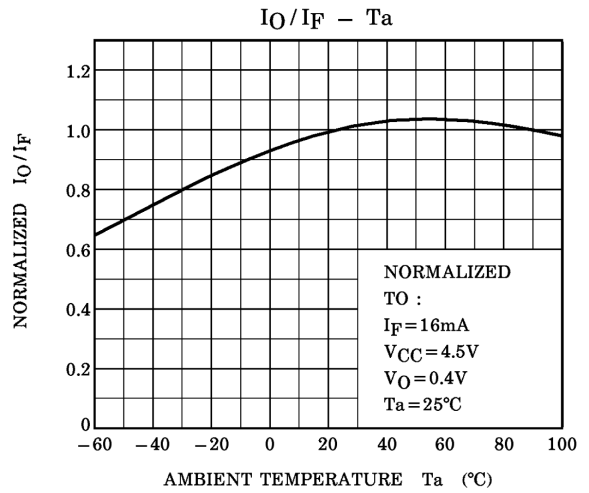
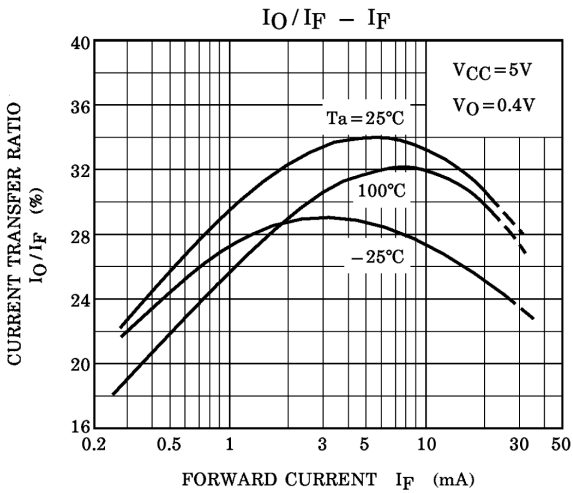
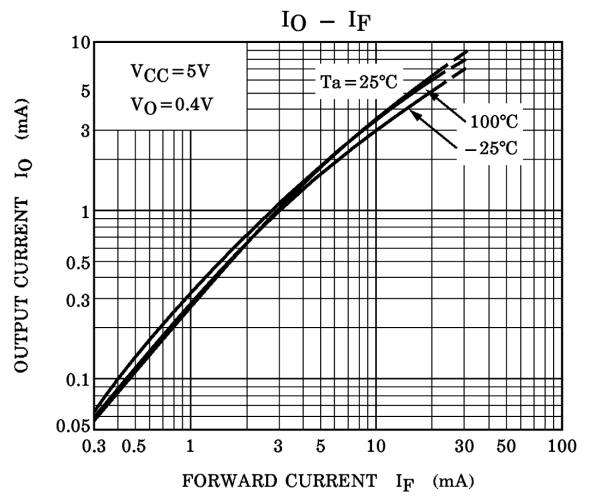
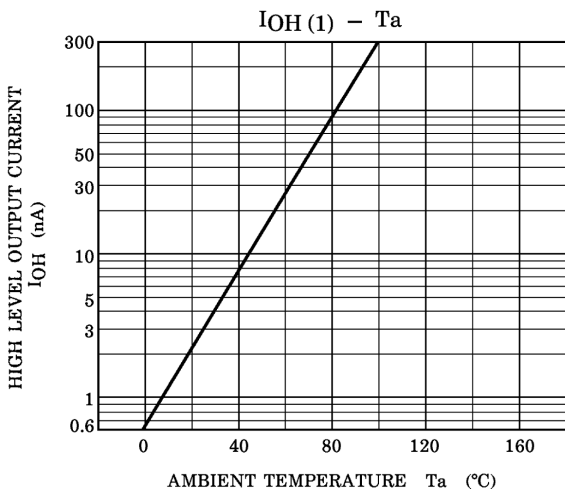
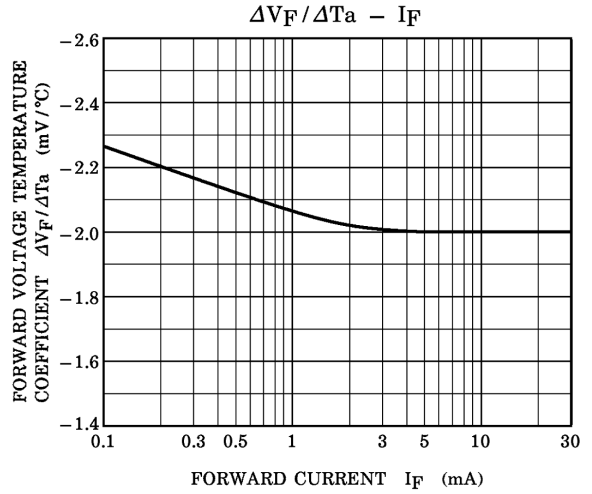
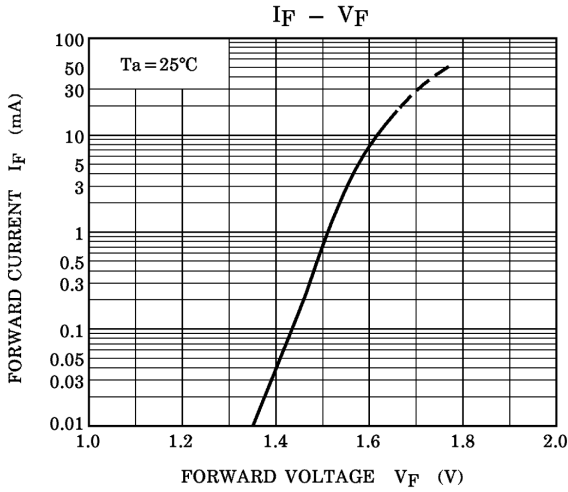

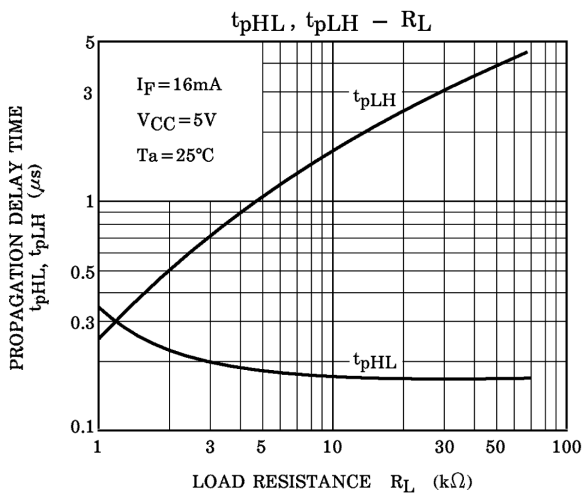
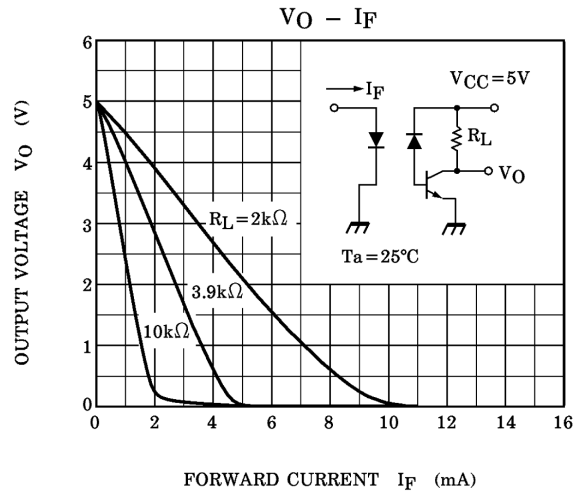
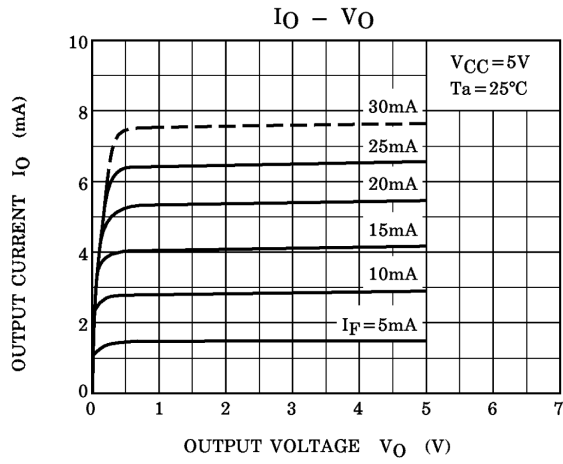

RESTRICTIONS ON PRODUCT USE

000707EBC

- TOSHIBA is continually working to improve the quality and reliability of its products. Nevertheless, semiconductor devices in general can malfunction or fail due to their inherent electrical sensitivity and vulnerability to physical stress. It is the responsibility of the buyer, when utilizing TOSHIBA products, to comply with the standards of safety in making a safe design for the entire system, and to avoid situations in which a malfunction or failure of such TOSHIBA products could cause loss of human life, bodily injury or damage to property.
In developing your designs, please ensure that TOSHIBA products are used within specified operating ranges as set forth in the most recent TOSHIBA products specifications. Also, please keep in mind the precautions and conditions set forth in the "Handling Guide for Semiconductor Devices," or "TOSHIBA Semiconductor Reliability Handbook" etc..
- The TOSHIBA products listed in this document are intended for usage in general electronics applications (computer, personal equipment, office equipment, measuring equipment, industrial robotics, domestic appliances, etc.). These TOSHIBA products are neither intended nor warranted for usage in equipment that requires extraordinarily high quality and/or reliability or a malfunction or failure of which may cause loss of human life or bodily injury ("Unintended Usage"). Unintended Usage include atomic energy control instruments, airplane or spaceship instruments, transportation instruments, traffic signal instruments, combustion control instruments, medical instruments, all types of safety devices, etc.. Unintended Usage of TOSHIBA products listed in this document shall be made at the customer's own risk.
- Gallium arsenide (GaAs) is a substance used in the products described in this document. GaAs dust and fumes are toxic. Do not break, cut or pulverize the product, or use chemicals to dissolve them. When disposing of the products, follow the appropriate regulations. Do not dispose of the products with other industrial waste or with domestic garbage.
- The products described in this document are subject to the foreign exchange and foreign trade laws.
- The information contained herein is presented only as a guide for the applications of our products. No responsibility is assumed by TOSHIBA CORPORATION for any infringements of intellectual property or other rights of the third parties which may result from its use. No license is granted by implication or otherwise under any intellectual property or other rights of TOSHIBA CORPORATION or others.
- The information contained herein is subject to change without notice.