

TOSHIBA Photocoupler GaAs Ired & Photo-Thyristor

# TLP747G

- Office Machine
- Household Use Equipment
- Solid State Relay
- Switching Power Supply

The TOSHIBA TLP747G consists of a photo-thyristor optically coupled to a gallium arsenide infrared emitting diode in a six lead plastic DIP.

- Peak off-state voltage: 400 V (min.)
- Trigger LED current: 15 mA (max.)
- On-state current: 150 mA (max.)
- UL recognized: UL1577, file No. E67349
- BSI approved: BS EN60065: 1994  
Certificate No. 7364  
BS EN60950: 1992  
Certificate No. 7365
- SEMKO approved: SS4330784, certificate No. 9325163, 9522142  
Isolation voltage: 4000 Vrms (min.)
- Option (D4) type  
VDE approved: DIN VDE0884 / 06.92,  
Certificate No. 74286, 91808  
Maximum operating insulation voltage: 630, 890 VPK  
Highest permissible over voltage: 6000, 8000 VPK

**(Note)** When a VDE0884 approved type is needed, please designate the "option (D4)"

	7.62mm pich standard type	10.16mm pich TLPxxxF type
• Creepage distance	: 7.0mm (min.)	8.0mm (min.)
Clearance	: 7.0mm (min.)	8.0mm (min.)
Insulation thickness	: 0.5mm (min.)	0.5mm (min.)

Unit in mm

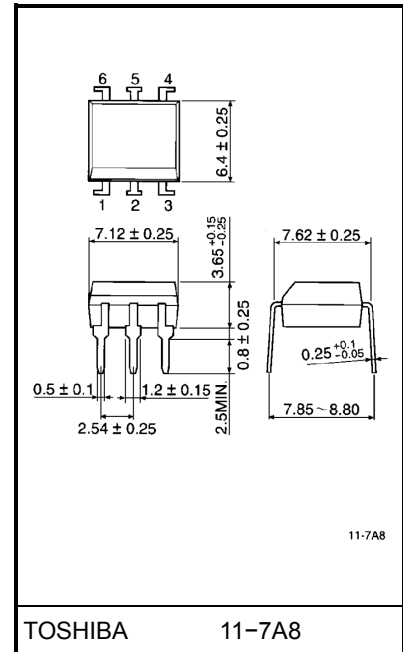

Weight: 0.42 g

### Pin Configuration (top view)

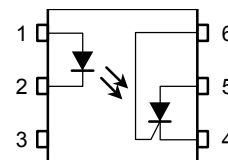

- 1 : Anode
- 2 : Cathode
- 3 : NC
- 4 : Cathode
- 5 : Anode
- 6 : Gate

## Maximum Ratings (Ta = 25°C)

Characteristic		Symbol	Rating	Unit
LED	Forward current	$I_F$	60	mA
	Forward current derating (Ta ≥ 39°C)	$\Delta I_F / ^\circ\text{C}$	-0.7	mA / °C
	Peak forward current (100µs pulse, 100pps)	$I_{FP}$	1	A
	Reverse voltage	$V_R$	5	V
	Junction temperature	$T_j$	125	°C
Detector	Peak forward voltage (RGK = 27kΩ)	$V_{DRM}$	400	V
	Peak reverse voltage (RGK = 27kΩ)	$V_{RRM}$	400	V
	On-state current	$I_{T(RMS)}$	150	mA
	On-state current derating (Ta ≥ 25°C)	$\Delta I_T / ^\circ\text{C}$	-2.0	mA / °C
	Peak on-state current (100 µs pulse, 120pps)	$I_{TP}$	3	A
	Peak one cycle surge current	$I_{TSM}$	2	A
	Peak reverse gate voltage	$V_{GM}$	5	V
	Power dissipation	$P_D$	150	mW
	Power dissipation derating (Ta ≥ 25°C)	$\Delta P_D / ^\circ\text{C}$	-2.0	mW / °C
	Junction temperature	$T_j$	100	°C
Storage temperature range		$T_{stg}$	-55~125	°C
Operating temperature range		$T_{opr}$	-40~100	°C
Lead soldering temperature (10s)		$T_{sol}$	260	°C
Total package power dissipation		$P_T$	250	mW
Total package power dissipation derating (Ta ≥ 25°C)		$\Delta P_T / ^\circ\text{C}$	-3.3	mW / °C
Isolation voltage (AC, 1min., R.H. ≤ 60%) (Note)		$BV_S$	4000	Vrms

(Note) Device considered a two terminal device: Pins 1, 2 and 3 shorted together, and pins 4, 5 and 6 shorted together.

## Recommended Operating Conditions

Characteristic	Symbol	Min.	Typ.	Max.	Unit
Supply voltage	$V_{AC}$	—	—	120	Vac
Forward current	$I_F$	20	—	25	mA
Operating temperature	$T_{opr}$	-25	—	85	°C
Gate to cathode resistance	$R_{GK}$	—	27	33	kΩ
Gate to cathode capacity	$C_{GK}$	—	0.01	0.1	µF

## Individual Electrical Characteristics (Ta = 25°C)

Characteristic		Symbol	Test Condition	Min.	Typ.	Max.	Unit	
LED	Forward voltage	$V_F$	$I_F = 10\text{mA}$	1.0	1.15	1.3	V	
	Reverse current	$I_R$	$V_R = 5\text{V}$	—	—	10	$\mu\text{A}$	
	Capacitance	$C_T$	$V = 0, f = 1\text{MHz}$	—	30	—	pF	
Detector	Off-state current	$I_{\text{DRM}}$	$V_{\text{AK}} = 400\text{V}$ $R_{\text{GK}} = 27\text{k}\Omega$	Ta = 25°C	—	10	5000	nA
				Ta = 100°C	—	1	100	$\mu\text{A}$
	Reverse current	$I_{\text{RRM}}$	$V_{\text{KA}} = 400\text{V}$ $R_{\text{GK}} = 27\text{k}\Omega$	Ta = 25°C	—	10	5000	nA
				Ta = 100°C	—	1	100	$\mu\text{A}$
	On-state voltage	$V_{\text{TM}}$	$I_{\text{TM}} = 100\text{mA}$	—	0.9	1.3	V	
	Holding current	$I_{\text{H}}$	$R_{\text{GK}} = 27\text{k}\Omega$	—	0.2	—	mA	
	Off-state dv / dt	dv / dt	$V_{\text{AK}} = 280\text{V}, R_{\text{GK}} = 27\text{k}\Omega$	5	10	—	V / $\mu\text{s}$	
Capacitance	$C_j$	$V = 0,$ $f = 1\text{MHz}$	Anode to gate	—	20	—	pF	
			Gate to cathode	—	350	—		

## Coupled Characteristics (Ta = 25°C)

Characteristic	Symbol	Test Condition	Min.	Typ.	Max.	Unit
Trigger LED current	$I_{\text{FT}}$	$V_{\text{AK}} = 6\text{V}, R_{\text{GK}} = 27\text{k}\Omega$	—	—	15	mA
Turn-on time	$t_{\text{on}}$	$I_F = 30\text{mA}, V_{\text{AA}} = 50\text{V}$ $R_{\text{GK}} = 27\text{k}\Omega$	—	10	—	$\mu\text{s}$
Coupled dv / dt	dv / dt	$V_S = 500\text{V}, R_{\text{GK}} = 27\text{k}\Omega$	500	—	—	V / $\mu\text{s}$
Capacitance (input to output)	$C_S$	$V_S = 0, f = 1\text{MHz}$	—	0.8	—	pF
Isolation resistance	$R_S$	$V_S = 500\text{V}, \text{R.H.} \leq 60\%$	$1 \times 10^{12}$	$10^{14}$	—	$\Omega$
Isolation voltage	$BV_S$	AC, 1 minute	4000	—	—	Vrms
		AC, 1 second, in oil	—	10000	—	
		DC, 1 minute, in oil	—	10000	—	Vdc

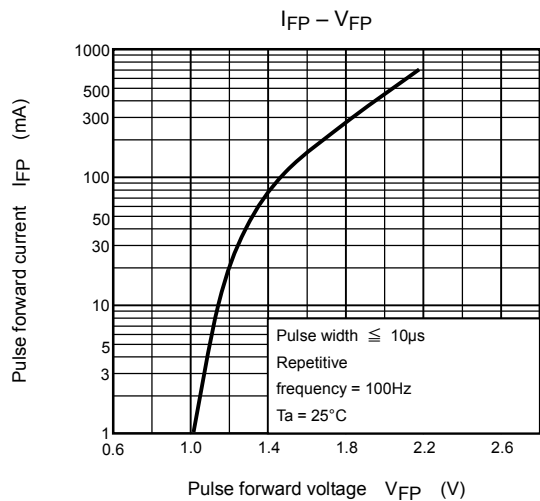
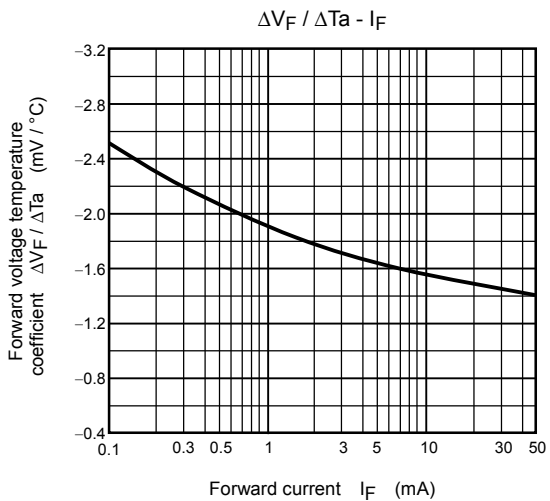
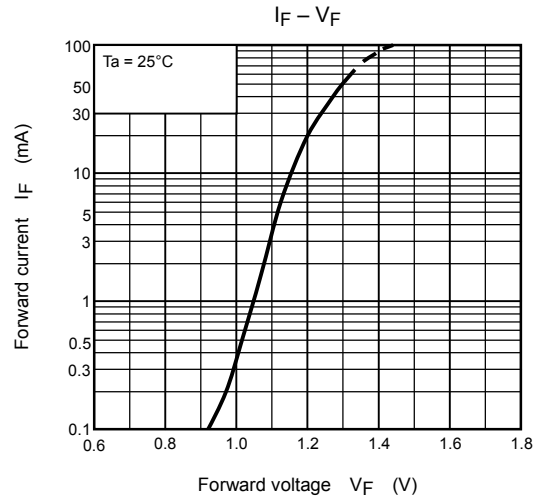
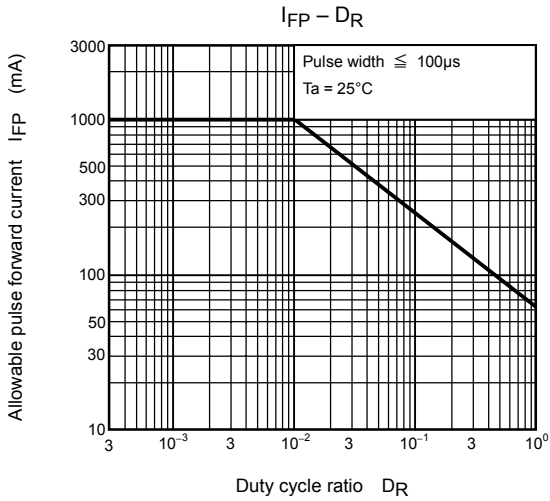
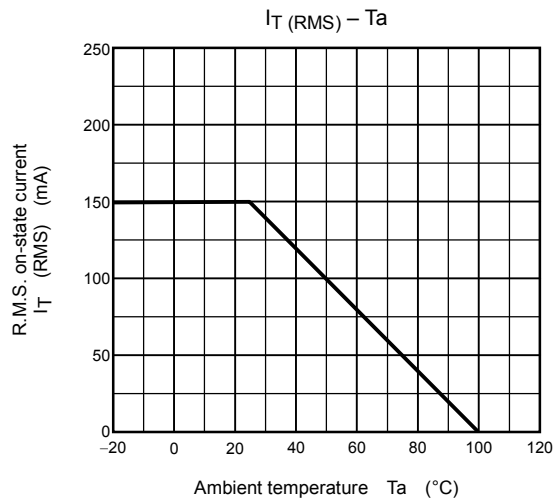
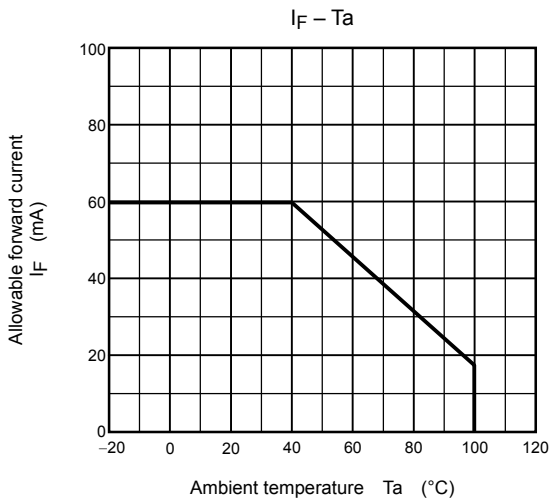

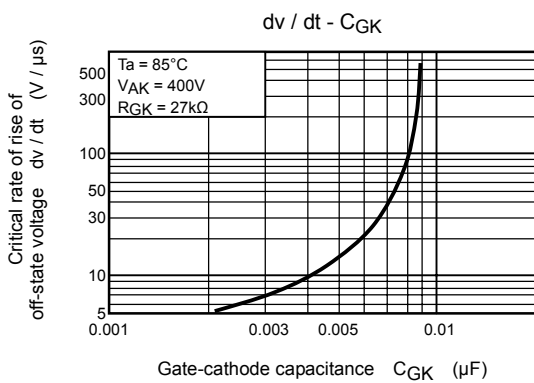
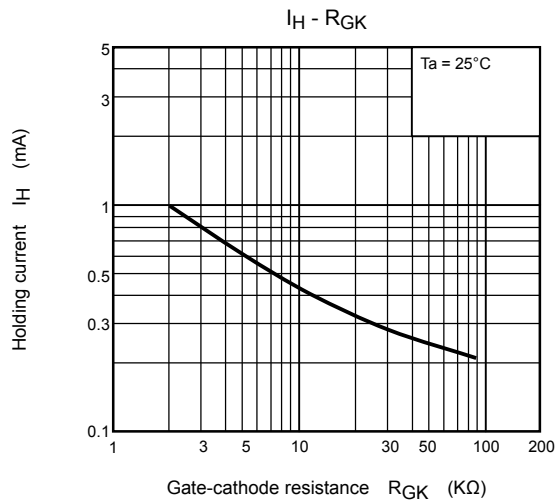
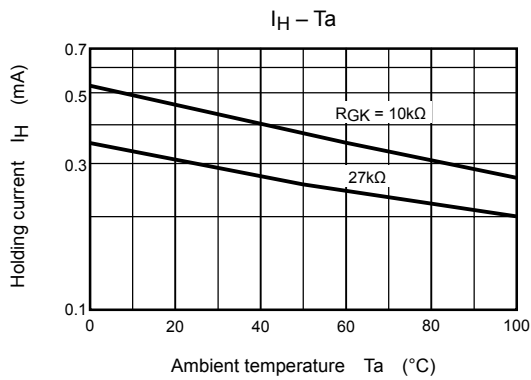
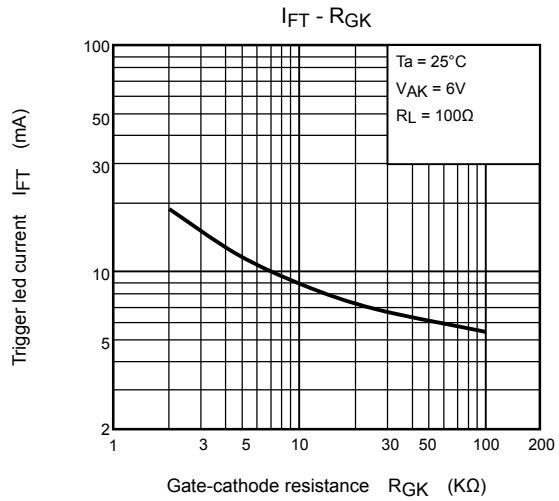
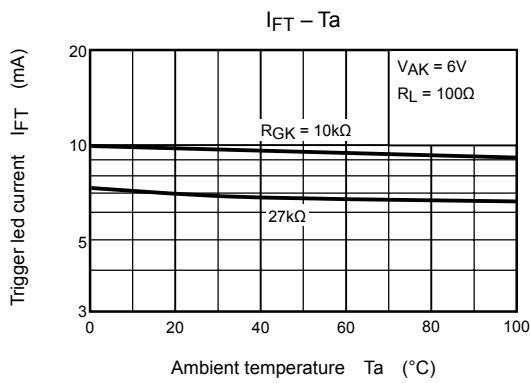
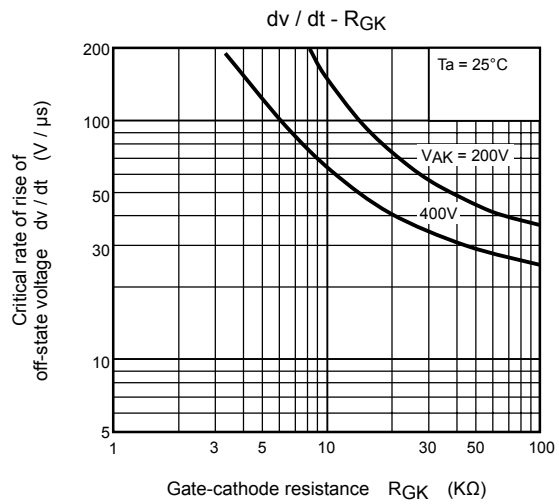
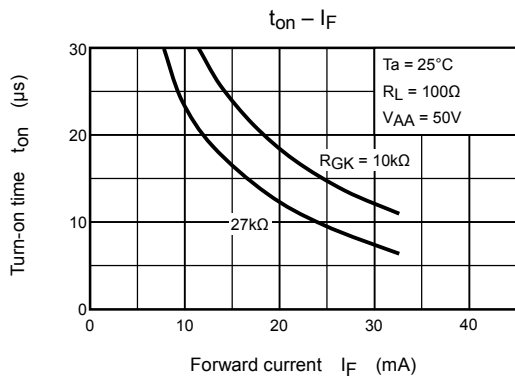

**RESTRICTIONS ON PRODUCT USE**

000707EBC

- TOSHIBA is continually working to improve the quality and reliability of its products. Nevertheless, semiconductor devices in general can malfunction or fail due to their inherent electrical sensitivity and vulnerability to physical stress. It is the responsibility of the buyer, when utilizing TOSHIBA products, to comply with the standards of safety in making a safe design for the entire system, and to avoid situations in which a malfunction or failure of such TOSHIBA products could cause loss of human life, bodily injury or damage to property.  
In developing your designs, please ensure that TOSHIBA products are used within specified operating ranges as set forth in the most recent TOSHIBA products specifications. Also, please keep in mind the precautions and conditions set forth in the "Handling Guide for Semiconductor Devices," or "TOSHIBA Semiconductor Reliability Handbook" etc..
- The TOSHIBA products listed in this document are intended for usage in general electronics applications (computer, personal equipment, office equipment, measuring equipment, industrial robotics, domestic appliances, etc.). These TOSHIBA products are neither intended nor warranted for usage in equipment that requires extraordinarily high quality and/or reliability or a malfunction or failure of which may cause loss of human life or bodily injury ("Unintended Usage"). Unintended Usage include atomic energy control instruments, airplane or spaceship instruments, transportation instruments, traffic signal instruments, combustion control instruments, medical instruments, all types of safety devices, etc.. Unintended Usage of TOSHIBA products listed in this document shall be made at the customer's own risk.
- Gallium arsenide (GaAs) is a substance used in the products described in this document. GaAs dust and fumes are toxic. Do not break, cut or pulverize the product, or use chemicals to dissolve them. When disposing of the products, follow the appropriate regulations. Do not dispose of the products with other industrial waste or with domestic garbage.
- The products described in this document are subject to the foreign exchange and foreign trade laws.
- The information contained herein is presented only as a guide for the applications of our products. No responsibility is assumed by TOSHIBA CORPORATION for any infringements of intellectual property or other rights of the third parties which may result from its use. No license is granted by implication or otherwise under any intellectual property or other rights of TOSHIBA CORPORATION or others.
- The information contained herein is subject to change without notice.