

# TLP560J

Triac Driver  
 Programmable Controllers  
 AC-Output Module  
 Solid State Relay

The TOSHIBA TLP560J consists of a photo-triac optically coupled to a gallium arsenide infrared emitting diode in a six lead plastic DIP package.

- Peak off-state voltage: 600V(min.)
- On-state current: 100mA(max.)
- Isolation voltage: 2500V<sub>rms</sub> (min.)
- UL recognized: UL1577, file no. E67349
- Isolation operating voltage: 2500V<sub>ac</sub> or 300V<sub>dc</sub> for isolation Groupe C\*1
- Trigger LED current

Classification*	Trigger LED Current (mA)		Marking Of Classification
	V <sub>T</sub> =6V, T <sub>a</sub> =25°C		
	Min.	Max.	
(IFT7)	—	7	T7
Standard	—	10	T7, blank

\*Ex. (IFT7); TLP560J(IFT7)

(Note) Application type name for certification test, please use standard product type name, i.e.

TLP560J(IFT7): TLP560J

\*1: According to VDE0110, table 4.

Unit in mm

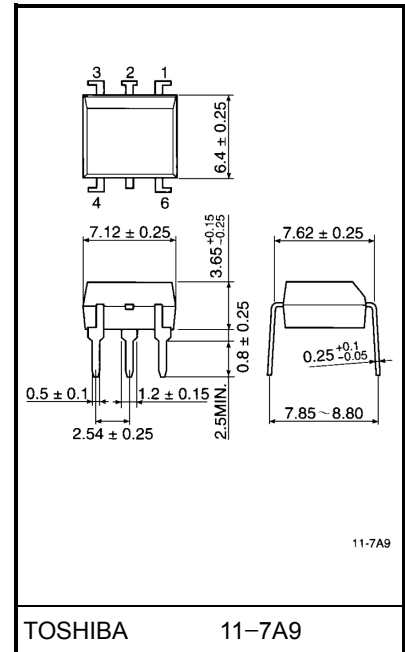

TOSHIBA 11-7A9

Weight: 0.39 g

### Pin Configuration (top view)

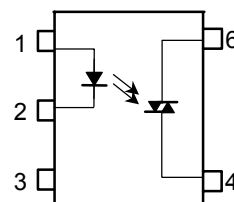

- 1: Anode
- 2: Cathode
- 3: N.C.
- 4: Terminal 1
- 6: Terminal 2

## Maximum Ratings (Ta = 25°C)

Characteristic		Symbol	Rating	Unit
LED	Forward current	$I_F$	50	mA
	Forward current derating (Ta ≥ 53°C)	$\Delta I_F / ^\circ\text{C}$	-0.7	mA / °C
	Peak forward current (100µs pulse, 100pps)	$I_{FP}$	1	A
	Reverse voltage	$V_R$	5	V
	Junction temperature	$T_j$	125	°C
Detector	Off-state output terminal voltage	$V_{DRM}$	600	V
	On-state RMS current	Ta=25°C	100	mA
		Ta=70°C	50	
	On-state current derating (Ta ≥ 25°C)	$\Delta I_T / ^\circ\text{C}$	-1.1	mA / °C
	Peak on-state current (100µs pulse, 120pps)	$I_{TP}$	2	A
	Peak nonrepetitive surge current (Pw=10ms, DC=10%)	$I_{TSM}$	1.2	A
	Junction temperature	$T_j$	115	°C
Storage temperature range	$T_{stg}$	-55~125	°C	
Operating temperature range	$T_{opr}$	-40~100	°C	
Lead soldering temperature (10s)	$T_{sol}$	260	°C	
Isolation voltage (AC, 1min., R.H. ≤ 60%)	$BV_S$	2500	V <sub>rms</sub>	

## Recommended Operating Conditions

Characteristic	Symbol	Min.	Typ.	Max.	Unit
Supply voltage	$V_{AC}$	—	—	240	V <sub>ac</sub>
Forward current	$I_F$	15	20	25	mA
Peak on-state current	$I_{TP}$	—	—	—	A
Operating temperature	$T_{opr}$	-25	—	85	°C

**Individual Electrical Characteristics (Ta = 25°C)**

Characteristic		Symbol	Test Condition	Min.	Typ.	Max.	Unit
LED	Forward voltage	$V_F$	$I_F=10\text{mA}$	1.0	1.15	1.3	V
	Reverse current	$I_R$	$V_R=5\text{V}$	—	—	10	$\mu\text{A}$
	Capacitance	$C_T$	$V=0, f=1\text{MHz}$	—	10	—	pF
Detector	Peak off-state current	$I_{DRM}$	$V_{DRM}=600\text{V}$	—	10	1000	nA
	Peak on-state voltage	$V_{TM}$	$I_{TM}=100\text{mA}$	—	1.7	3.0	V
	Holding current	$I_H$	—	—	1.0	—	mA
	Critical rate of rise of off-state voltage	$dv/dt$	$V_{in}=240\text{V}_{rms}, T_a=85^\circ\text{C}$ (fig.1)	—	500	—	V / $\mu\text{s}$
	Critical rate of rise of commutating voltage	$dv/dt(c)$	$V_{in}=60\text{V}_{rms}, I_T=15\text{mA}$ (fig.1)	—	0.2	—	V / $\mu\text{s}$

**Coupled Electrical Characteristics (Ta = 25°C)**

Characteristic	Symbol	Test Condition	Min.	Typ.	Max.	Unit
Trigger LED current	$I_{FT}$	$V_T=6\text{V}, R_L=100\Omega$	—	5	10	mA
Capacitance (input to output)	$C_S$	$V_S=0, f=1\text{MHz}$	—	0.8	—	pF
Isolation resistance	$R_S$	$V_S=500\text{V}$	$5 \times 10^{10}$	$10^{14}$	—	$\Omega$
Isolation voltage	$BV_S$	AC, 1 minute	2500	—	—	$V_{rms}$
		AC, 1 second, in oil	—	5000	—	
		DC, 1 minute, in oil	—	5000	—	$V_{dc}$

Fig.1:  $dv/dt$  test circuit

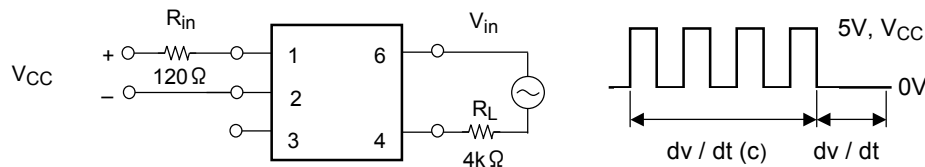

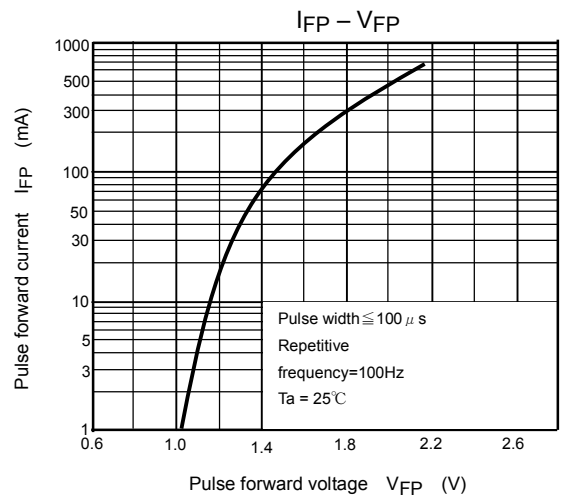
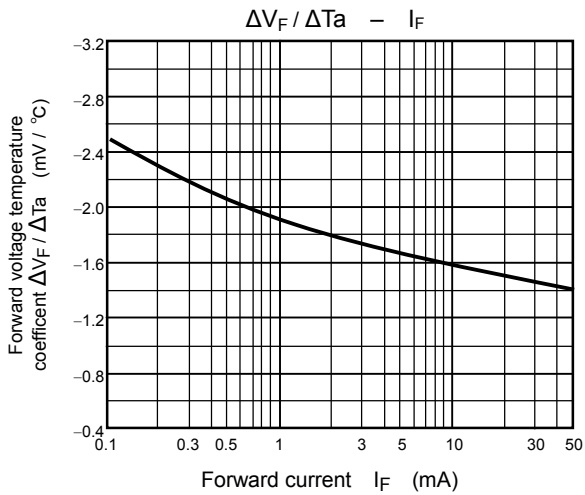
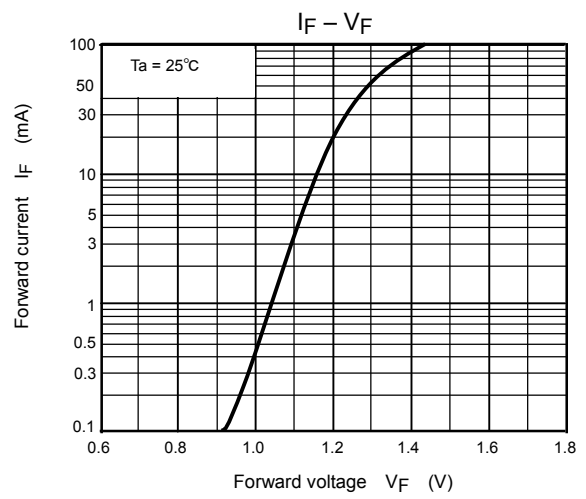
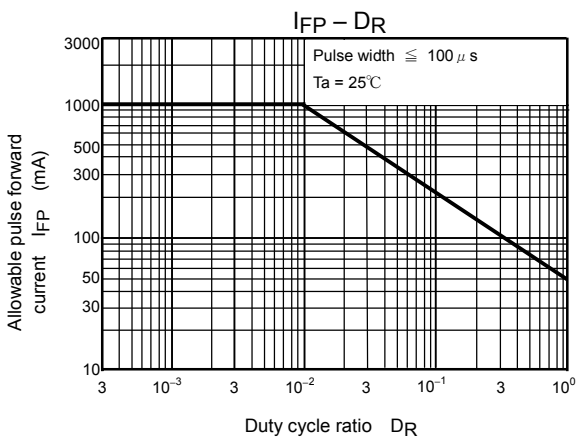
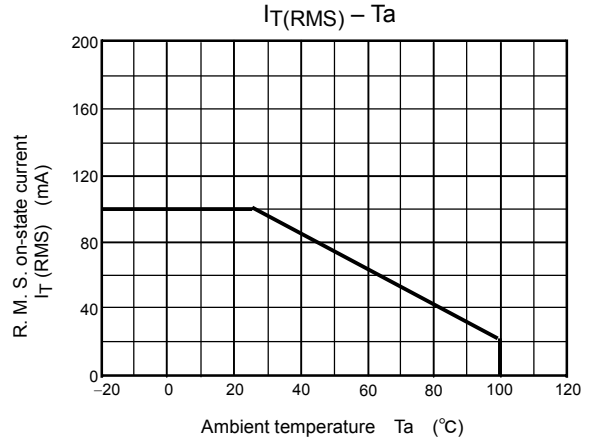
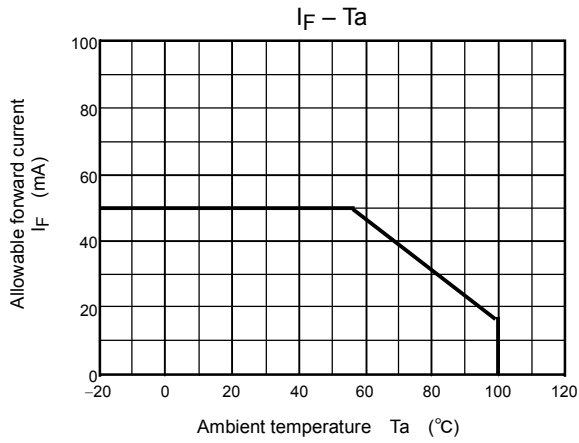

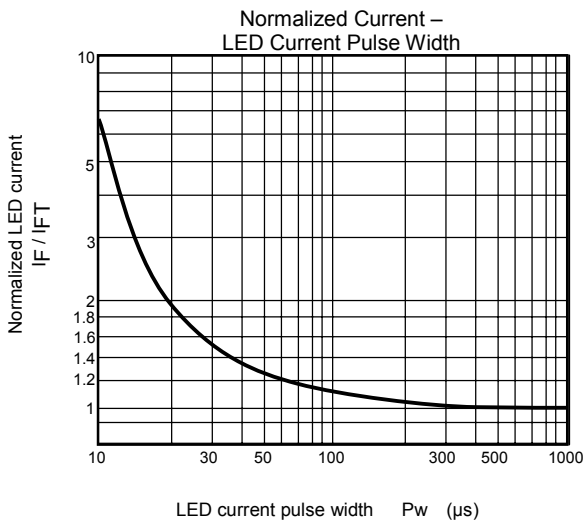
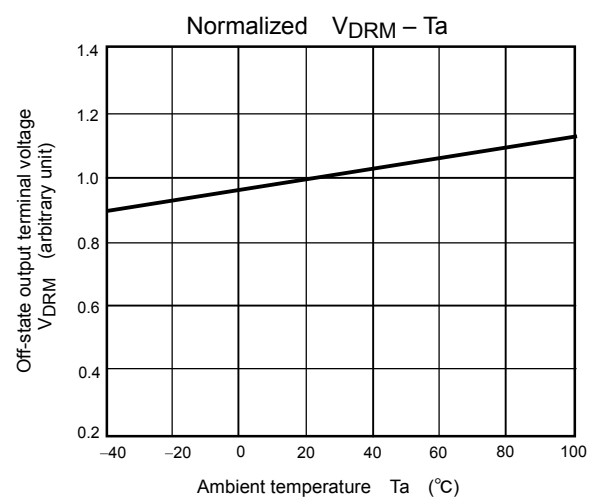
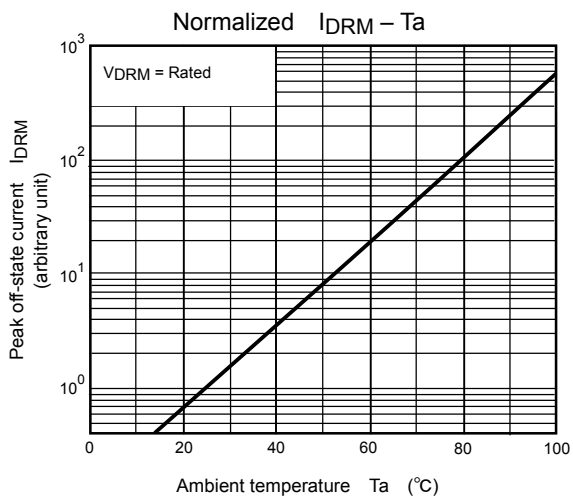
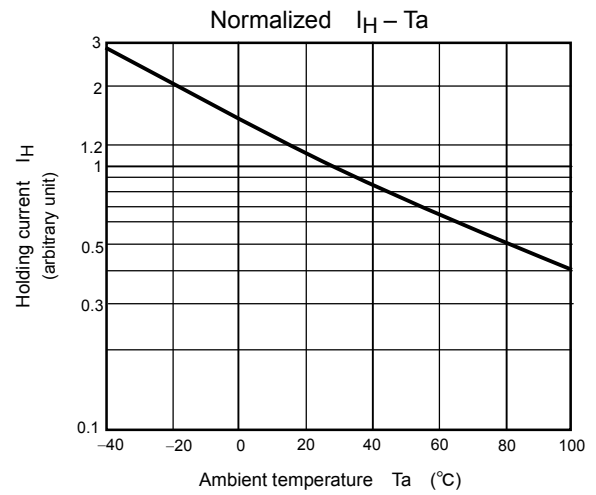
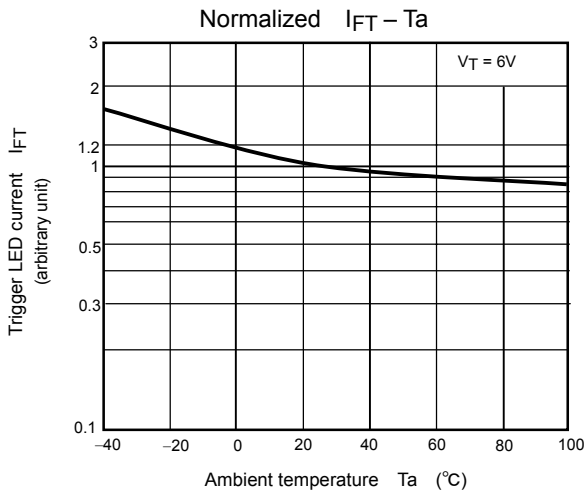

**RESTRICTIONS ON PRODUCT USE**

000707EBC

- TOSHIBA is continually working to improve the quality and reliability of its products. Nevertheless, semiconductor devices in general can malfunction or fail due to their inherent electrical sensitivity and vulnerability to physical stress. It is the responsibility of the buyer, when utilizing TOSHIBA products, to comply with the standards of safety in making a safe design for the entire system, and to avoid situations in which a malfunction or failure of such TOSHIBA products could cause loss of human life, bodily injury or damage to property.  
In developing your designs, please ensure that TOSHIBA products are used within specified operating ranges as set forth in the most recent TOSHIBA products specifications. Also, please keep in mind the precautions and conditions set forth in the "Handling Guide for Semiconductor Devices," or "TOSHIBA Semiconductor Reliability Handbook" etc..
- The TOSHIBA products listed in this document are intended for usage in general electronics applications (computer, personal equipment, office equipment, measuring equipment, industrial robotics, domestic appliances, etc.). These TOSHIBA products are neither intended nor warranted for usage in equipment that requires extraordinarily high quality and/or reliability or a malfunction or failure of which may cause loss of human life or bodily injury ("Unintended Usage"). Unintended Usage include atomic energy control instruments, airplane or spaceship instruments, transportation instruments, traffic signal instruments, combustion control instruments, medical instruments, all types of safety devices, etc.. Unintended Usage of TOSHIBA products listed in this document shall be made at the customer's own risk.
- Gallium arsenide (GaAs) is a substance used in the products described in this document. GaAs dust and fumes are toxic. Do not break, cut or pulverize the product, or use chemicals to dissolve them. When disposing of the products, follow the appropriate regulations. Do not dispose of the products with other industrial waste or with domestic garbage.
- The products described in this document are subject to the foreign exchange and foreign trade laws.
- The information contained herein is presented only as a guide for the applications of our products. No responsibility is assumed by TOSHIBA CORPORATION for any infringements of intellectual property or other rights of the third parties which may result from its use. No license is granted by implication or otherwise under any intellectual property or other rights of TOSHIBA CORPORATION or others.
- The information contained herein is subject to change without notice.