

TOSHIBA Photocoupler Photorelay

TLP3120

High-Speed Memory Tester
 High-Speed Logic Tester
 High-Frequency Measurement Equipment

The Toshiba TLP3120 consists of an aluminum gallium arsenide infrared emitting diode optically coupled to a photo-MOSFET in a SOP, which is suitable for surface mount assembly.

- 6-pin SOP (2.54SOP6): 2.1 mm high, 2.54 mm pitch
- Normally opened (form A) device
- Peak OFF-state voltage: 80 V (min)
- Trigger LED current: 5 mA (max)
- ON-state current: 1.25 A (max)
- ON-state resistance: 0.15 Ω (max)
- Capacitance: 1000 pF (max)
- Isolation voltage: 1500 V_{rms} (min)

Pin Configuration (top view)

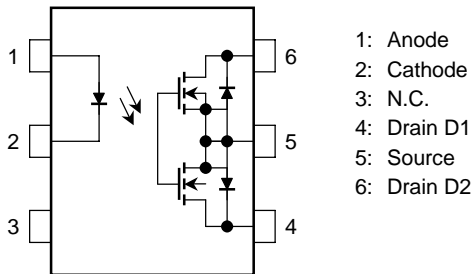

Unit: mm

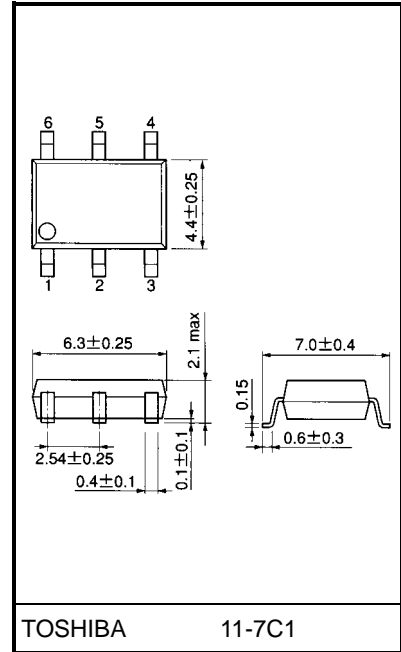

Weight: 0.13 g (typ.)

Maximum Ratings (Ta = 25°C)

| Characteristics | | Symbol | Rating | Unit |
|-------------------------------------------------------|---------------------------------------|--------------------------------|---------|-------|
| Led | Forward current | I_F | 50 | mA |
| | Forward current derating (Ta ≥ 25°C) | $\Delta I_F/^\circ\text{C}$ | -0.5 | mA/°C |
| | Reverse voltage | V_R | 5 | V |
| | Junction temperature | T_j | 125 | °C |
| Detector | OFF-state output terminal voltage | V_{OFF} | 80 | V |
| | ON-state current | I_{ON} | 1.25 | A |
| | ON-state current derating (Ta ≥ 25°C) | $\Delta I_{ON}/^\circ\text{C}$ | -12.5 | mA/°C |
| | Junction temperature | T_j | 125 | °C |
| Storage temperature range | | T_{stg} | -40~125 | °C |
| Operating temperature range | | T_{opr} | -20~85 | °C |
| Lead soldering temperature (10 s) | | T_{sol} | 260 | °C |
| Isolation voltage (AC, 1 min, R.H. ≤ 60%) (Note 1) | | BV_s | 1500 | Vrms |

Note 1: Device is considered as a two-terminal device. LED side pins are shorted together and detector side pins are shorted together.

Recommended Operating Conditions

| Characteristics | Symbol | Min | Typ. | Max | Unit |
|-----------------------|-----------|-----|------|------|------|
| Supply voltage | V_{DD} | — | — | 64 | V |
| Forward current | I_F | 5 | — | 30 | mA |
| ON-state current | I_{ON} | — | — | 1.25 | A |
| Operating temperature | T_{opr} | 25 | — | 60 | °C |

Individual Electrical Characteristics (Ta = 25°C)

| Characteristics | | Symbol | Test Condition | Min | Typ. | Max | Unit |
|-----------------|-------------------|-----------|--------------------------------------------------|-----|------|------|------|
| Led | Forward current | V_F | $I_F = 10 \text{ mA}$ | 1.0 | 1.15 | 1.3 | V |
| | Reverse current | I_R | $V_R = 5 \text{ V}$ | — | — | 10 | μA |
| | Capacitance | C_T | $V = 0, f = 1 \text{ MHz}$ | — | 15 | — | pF |
| Detector | OFF-state current | I_{OFF} | $V_{OFF} = 20 \text{ V}, T_a = 50^\circ\text{C}$ | — | 1200 | 1500 | pA |
| | Capacitance | C_{OFF} | $V = 0, f = 100 \text{ MHz}$ | — | 460 | 1000 | pF |

Coupled Electrical Characteristics (Ta = 25°C)

| Characteristics | Symbol | Test Condition | Min | Typ. | Max | Unit |
|---------------------|----------|-----------------------------------------------|-----|------|------|----------|
| Trigger LED current | I_{FT} | $I_{ON} = 1.25 \text{ A}$ | — | 2 | 5 | mA |
| Return LED current | I_{FC} | $I_{OFF} = 10 \mu\text{A}$ | 0.2 | — | — | mA |
| ON-state resistance | R_{ON} | $I_{ON} = 1.25 \text{ A}, I_F = 5 \text{ mA}$ | — | 0.11 | 0.15 | Ω |

Isolation Characteristics (Ta = 25°C)

| Characteristics | Symbol | Test Condition | Min | Typ. | Max | Unit |
|-----------------------------|--------|----------------------------------------------|--------------------|-----------|-----|----------|
| Capacitance input to output | C_S | $V_S = 0 \text{ V}, f = 1 \text{ MHz}$ | — | 0.8 | — | pF |
| Isolation resistance | R_S | $V_S = 500 \text{ V}, \text{R.H.} \leq 60\%$ | 5×10^{10} | 10^{14} | — | Ω |
| Isolation voltage | BV_S | AC, 1 min | 1500 | — | — | Vrms |
| | | AC, 1 s (in oil) | — | 3000 | — | — |
| | | DC, 1 min (in oil) | — | 3000 | — | Vdc |

Switching Characteristics (Ta = 25°C)

| Characteristics | Symbol | Test Condition | Min | Typ. | Max | Unit |
|-----------------|-----------|------------------------------------------------------|-----|------|-----|------|
| Turn-ON time | t_{ON} | $R_L = 200 \Omega$ | — | 2.0 | 3.0 | ms |
| Turn-OFF time | t_{OFF} | $V_{DD} = 20 \text{ V}, I_F = 5 \text{ mA}$ (Note 2) | — | 0.7 | 1.0 | |

Note 2: Switching time test circuit

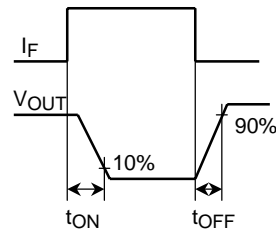
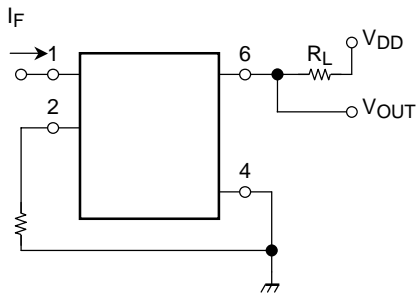

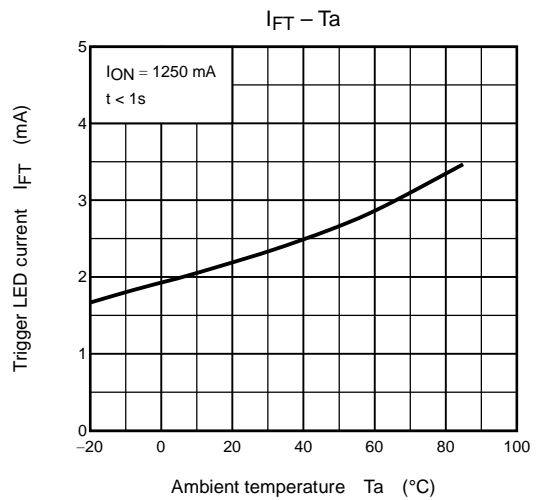
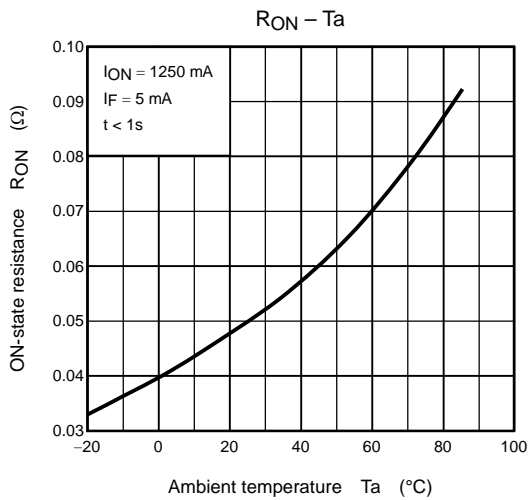
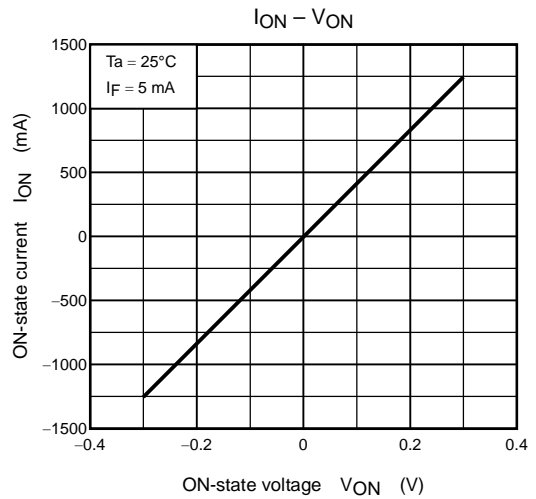
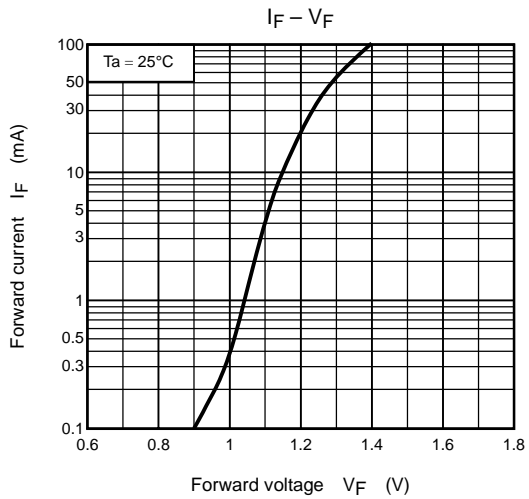
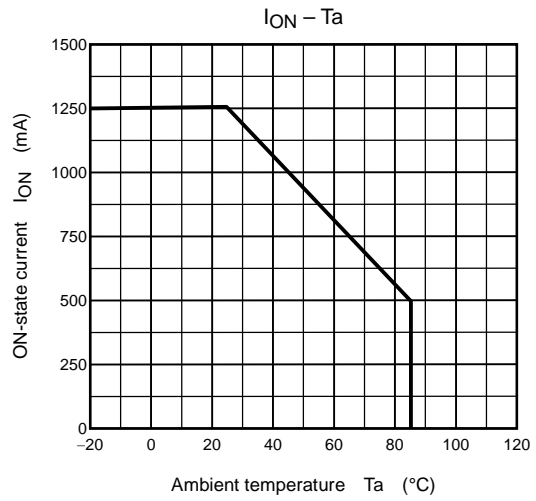
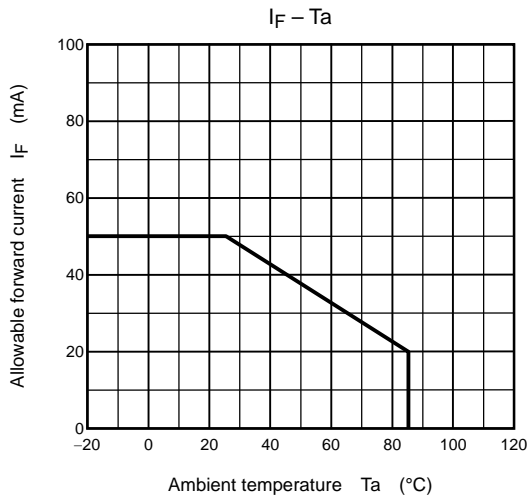

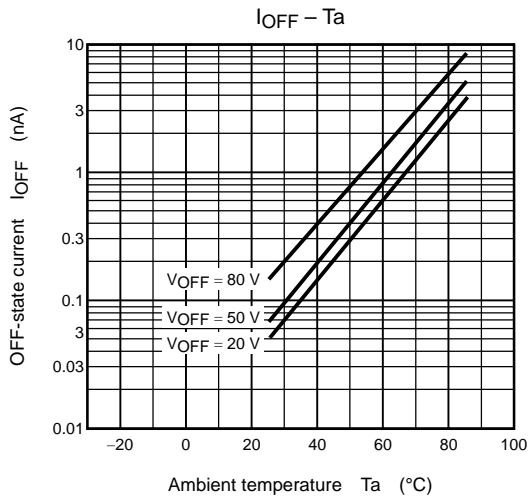
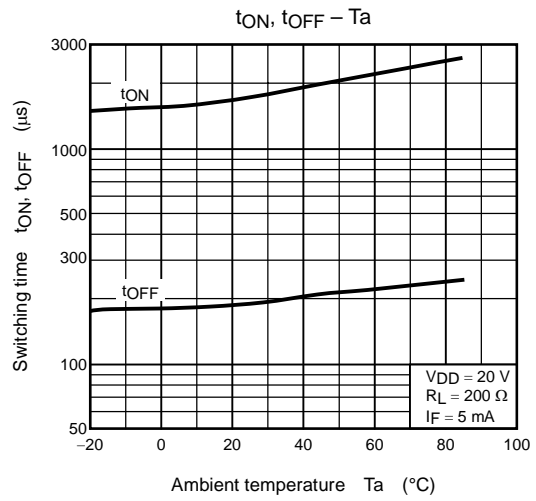
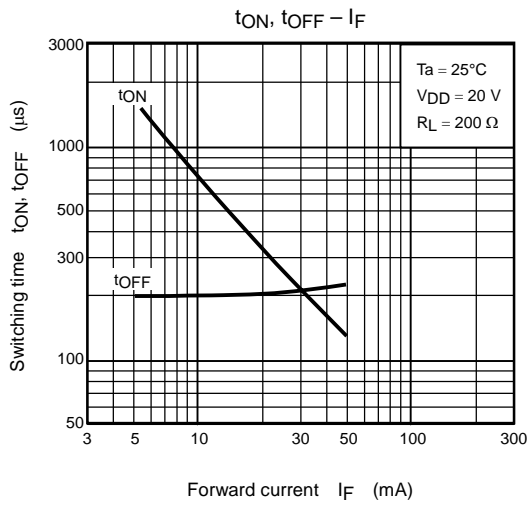

RESTRICTIONS ON PRODUCT USE

000707EBC

- TOSHIBA is continually working to improve the quality and reliability of its products. Nevertheless, semiconductor devices in general can malfunction or fail due to their inherent electrical sensitivity and vulnerability to physical stress. It is the responsibility of the buyer, when utilizing TOSHIBA products, to comply with the standards of safety in making a safe design for the entire system, and to avoid situations in which a malfunction or failure of such TOSHIBA products could cause loss of human life, bodily injury or damage to property.
In developing your designs, please ensure that TOSHIBA products are used within specified operating ranges as set forth in the most recent TOSHIBA products specifications. Also, please keep in mind the precautions and conditions set forth in the "Handling Guide for Semiconductor Devices," or "TOSHIBA Semiconductor Reliability Handbook" etc..
- The TOSHIBA products listed in this document are intended for usage in general electronics applications (computer, personal equipment, office equipment, measuring equipment, industrial robotics, domestic appliances, etc.). These TOSHIBA products are neither intended nor warranted for usage in equipment that requires extraordinarily high quality and/or reliability or a malfunction or failure of which may cause loss of human life or bodily injury ("Unintended Usage"). Unintended Usage include atomic energy control instruments, airplane or spaceship instruments, transportation instruments, traffic signal instruments, combustion control instruments, medical instruments, all types of safety devices, etc.. Unintended Usage of TOSHIBA products listed in this document shall be made at the customer's own risk.
- Gallium arsenide (GaAs) is a substance used in the products described in this document. GaAs dust and fumes are toxic. Do not break, cut or pulverize the product, or use chemicals to dissolve them. When disposing of the products, follow the appropriate regulations. Do not dispose of the products with other industrial waste or with domestic garbage.
- The products described in this document are subject to the foreign exchange and foreign trade laws.
- The information contained herein is presented only as a guide for the applications of our products. No responsibility is assumed by TOSHIBA CORPORATION for any infringements of intellectual property or other rights of the third parties which may result from its use. No license is granted by implication or otherwise under any intellectual property or other rights of TOSHIBA CORPORATION or others.
- The information contained herein is subject to change without notice.