

TLP3110

Measurement Instruments

Logic IC Testers / Memory Testers

Board Testers / Scanners

The TOSHIBA mini flat photo relay TLP3110 is a small outline photo relay, suitable for surface mount assembly.

The TLP3110 consists of a GaAs infrared emitting diode optically coupled to a photo-MOSFET in a 4 pin lead package (MFSOP6), and has characteristics of small off-state current and small output terminal capacitance, which enable the TLP3110 to be applied to measurement instruments.

- 1-form-A
- Peak off-state voltage: 60 V (min.)
- Trigger LED current: 4 mA (max.)
- On-state current: 350 mA (max.)
- On-state resistance: 1.2 Ω (max.)
- Isolation voltage: 1500 V_{rms} (min.)

Pin Configuration (top view)

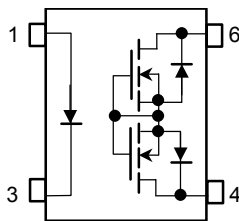

- 1 : Anode
- 3 : Cathode
- 4 : Drain
- 6 : Drain

Unit in mm

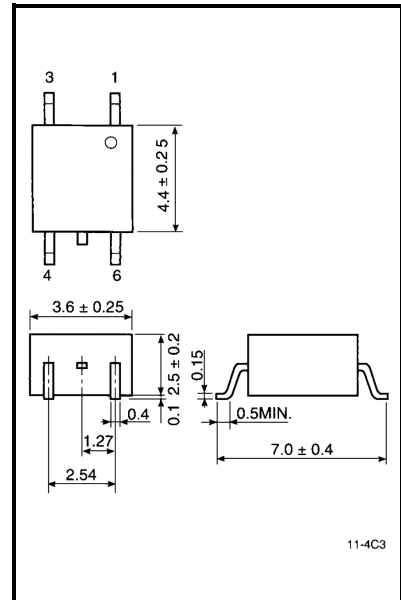

JEDEC	—
EIAJ	—
TOSHIBA	11-4C3

Weight: 0.1 g

Maximum Ratings (Ta = 25°C)

Characteristic		Symbol	Rating	Unit
LED	Forward current	I_F	50	mA
	Reverse voltage	V_R	6	V
	Junction temperature	T_j	125	°C
Detector	Off-state output voltage	V_{OFF}	60	V
	On-state current	I_{ON}	350	mA
	Junction temperature	T_j	125	°C
Storage temperature		T_{stg}	-40~125	°C
Operating temperature		T_{opr}	-20~85	°C
Lead soldering temperature (10 s)		T_{sol}	260	°C
Isolation voltage (AC, 1 min., R.H.≤ 60%) (Note 1)		BV_S	1500	V_{rms}

(Note 1): Device considered a two-terminal device: Pins 1 and 3 shorted together, and pins 4 and 6 shorted together.

Recommended Operating Conditions

Characteristic	Symbol	Min.	Typ.	Max.	Unit
Supply voltage	V_{OFF}	—	—	48	V
Forward current	I_F	10	—	30	mA
On-state current	I_{ON}	—	—	350	mA
Operating temperature	T_{opr}	25	—	50	°C

Individual Electrical Characteristics (Ta = 25°C)

Characteristic		Symbol	Test Condition	Min.	Typ.	Max.	Unit
LED	Forward voltage	V_F	$I_F = 20 \text{ mA}$	1.0	1.2	1.4	V
	Reverse voltage	I_R	$V_R = 6 \text{ V}$	—	—	10	μA
	Capacitance	C_T	$V = 0, f = 1 \text{ MHz}$	—	15	—	pF
Detector	Off-state current	I_{OFF}	$V_{OFF} = 30 \text{ V}, T_a = 50 \text{ °C}$	—	0.4	1	nA
	Capacitance	C_{OFF}	$V = 0, f = 1 \text{ MHz}$	—	100	150	pF

Coupled Electrical Characteristics (Ta = 25°C)

Characteristic	Symbol	Test Condition	Min.	Typ.	Max.	Unit
Trigger LED current	I_{FT}	$I_{ON} = 350 \text{ mA}$	—	—	4	mA
On-state resistance	R_{ON}	$I_{ON} = 350 \text{ mA}, I_F = 5 \text{ mA}$	—	0.9	1.2	Ω

Isolation Characteristics (Ta = 25°C)

Characteristic	Symbol	Test Condition	Min.	Typ.	Max.	Unit
Capacitance input to output	C _S	V _S = 0 V, f = 1 MHz	—	0.8	—	pF
Isolation resistance	R _S	V _S = 500 V, R.H. ≤ 60%	5×10 ¹⁰	10 ¹⁴	—	Ω
Isolation voltage	BV _S	AC, 1 minute	1500	—	—	V _{rms}
		AC, 1 second (in oil)	—	3000	—	
		DC, 1 minute (in oil)	—	3000	—	V _{dc}

Switching Characteristics (Ta = 25°C)

Characteristic	Symbol	Test Condition	Min.	Typ.	Max.	Unit
Turn-on time	t _{ON}	R _L = 200Ω (Note 2) V _{DD} = 20 V, I _F = 10 mA	—	—	1	ms
Turn-off time	t _{OFF}		—	—	1	

(Note 2): Switching time test circuit

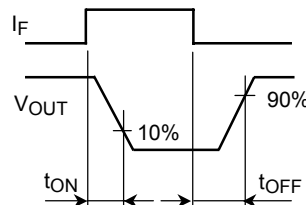
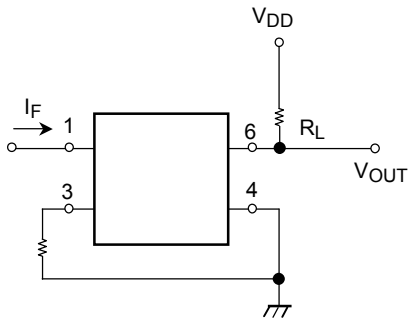

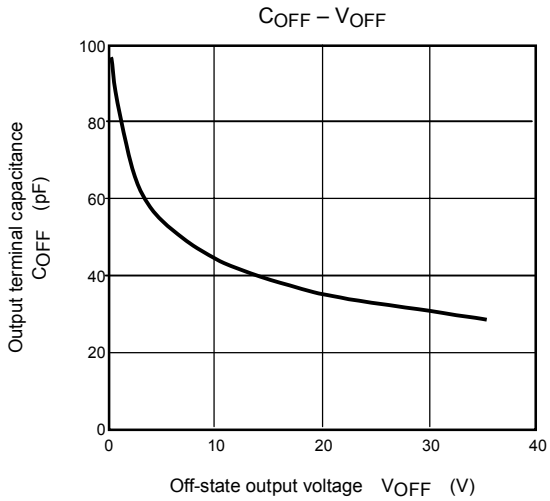
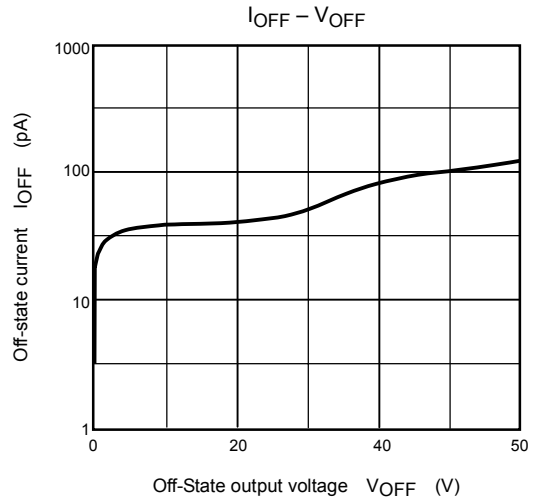
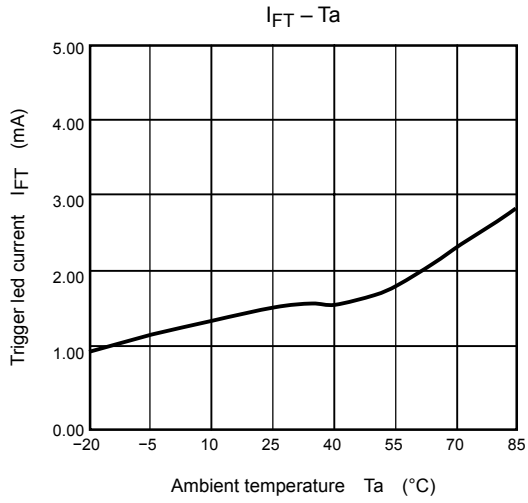

RESTRICTIONS ON PRODUCT USE

000707EBC

- TOSHIBA is continually working to improve the quality and reliability of its products. Nevertheless, semiconductor devices in general can malfunction or fail due to their inherent electrical sensitivity and vulnerability to physical stress. It is the responsibility of the buyer, when utilizing TOSHIBA products, to comply with the standards of safety in making a safe design for the entire system, and to avoid situations in which a malfunction or failure of such TOSHIBA products could cause loss of human life, bodily injury or damage to property.
In developing your designs, please ensure that TOSHIBA products are used within specified operating ranges as set forth in the most recent TOSHIBA products specifications. Also, please keep in mind the precautions and conditions set forth in the "Handling Guide for Semiconductor Devices," or "TOSHIBA Semiconductor Reliability Handbook" etc..
- The TOSHIBA products listed in this document are intended for usage in general electronics applications (computer, personal equipment, office equipment, measuring equipment, industrial robotics, domestic appliances, etc.). These TOSHIBA products are neither intended nor warranted for usage in equipment that requires extraordinarily high quality and/or reliability or a malfunction or failure of which may cause loss of human life or bodily injury ("Unintended Usage"). Unintended Usage include atomic energy control instruments, airplane or spaceship instruments, transportation instruments, traffic signal instruments, combustion control instruments, medical instruments, all types of safety devices, etc.. Unintended Usage of TOSHIBA products listed in this document shall be made at the customer's own risk.
- Gallium arsenide (GaAs) is a substance used in the products described in this document. GaAs dust and fumes are toxic. Do not break, cut or pulverize the product, or use chemicals to dissolve them. When disposing of the products, follow the appropriate regulations. Do not dispose of the products with other industrial waste or with domestic garbage.
- The products described in this document are subject to the foreign exchange and foreign trade laws.
- The information contained herein is presented only as a guide for the applications of our products. No responsibility is assumed by TOSHIBA CORPORATION for any infringements of intellectual property or other rights of the third parties which may result from its use. No license is granted by implication or otherwise under any intellectual property or other rights of TOSHIBA CORPORATION or others.
- The information contained herein is subject to change without notice.