

# TLP2631

Isolated Line Receiver  
 Simplex / Multiplex Data Transmission  
 Computer-Peripheral Interface  
 Microprocessor System Interface  
 Digital Isolation For A / D, D / A Conversion

The TOSHIBA TLP2631 dual photocoupler consists of a pair of GaAlAs light emitting diode and integrated high gain, high speed photodetector. This unit is 8-lead DIP.

The output of the detector circuit is an open collector, Schottky clamped transistor.

A Faraday shield integrated on the photodetector chip reduces the effects of capacitive coupling between the input LED emitter and the high gain stages of the detector. This provides an effective common mode transient immunity of 1000V /  $\mu$ s.

- Input current threshold:  $I_F = 5\text{mA}(\text{max.})$
- Switching speed: 10MBd(typ.)
- Common mode transient immunity:  $\pm 1000\text{V} / \mu\text{s}(\text{min.})$
- Guaranteed performance over temperature: 0~70°C
- Isolation voltage: 2500V<sub>rms</sub>(min.)
- UL recognized: UL1577, file no. E67349

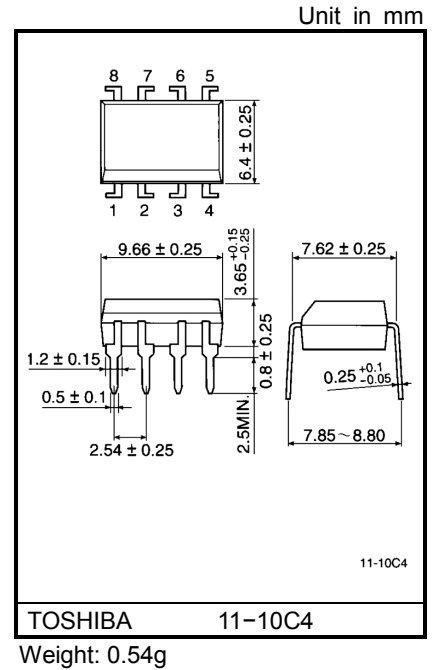

### Truth Table(positive logic)

Input	Output
H	L
L	H

A 0.01 to 0.1 $\mu$ F bypass capacitor must be connected between pins 8 and 5(see Note 1).

### Pin Configuration (top view)

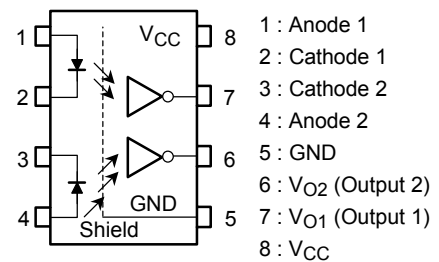

### Schematic

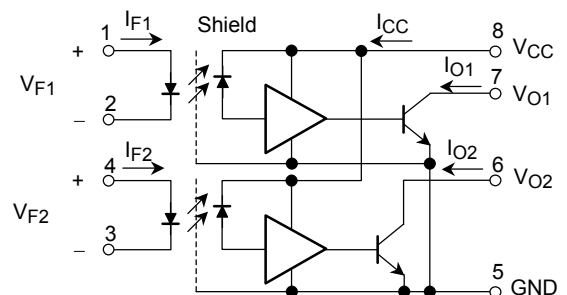

## Maximum Ratings (no derating required up to 70°C)

Characteristic		Symbol	Rating	Unit
LED	Forward current (each channel)	$I_F$	20	mA
	Pulse forward current (each channel)*	$I_{FP}$	30	mA
	Reverse voltage (each channel)	$V_R$	5	V
Detector	Output current (each channel)	$I_O$	16	mA
	Output voltage (each channel)	$V_O$	-0.5~7	V
	Supply voltage (1 minute maximum)	$V_{CC}$	7	V
	Output collector power dissipation (each channel)	$P_O$	40	mW
Operating temperature range		$T_{stg}$	-55~125	°C
Storage temperature range		$T_{opr}$	-40~85	°C
Lead soldering temperature (10s)**		$T_{sol}$	260	°C
Isolation voltage (AC, 1 min., R.H.≤ 60%, Note 3)		$BV_S$	2500	Vrms

\*  $t \leq 1$  msec duration.

\*\* 2mm below seating plane.

## Recommended Operating Conditions

Characteristic	Symbol	Min.	Typ.	Max.	Unit
Input current, low level, each channel	$I_{FL}$	0	—	250	μA
Input current, high level, each channel	$I_{FH}$	6.3*	—	20	mA
Supply voltage, output	$V_{CC}$	4.5	5	5.5	V
Fan out (TTL load, each channel)	N	—	—	8	
Operating temperature	$T_{opr}$	0	—	70	°C

\*6.3mA is a guard banded value which allows for at least 20% CTR degradation.

Initial input current threshold value is 5.0mA or less.

## Electrical Characteristics (Ta = 0~70°C unless otherwise noted)

Characteristic	Symbol	Test Condition	Min.	Typ. *	Max.	Unit
Input forward voltage (each channel)	$V_F$	$I_F = 10\text{mA}$ , $T_a = 25^\circ\text{C}$	—	1.65	1.75	V
Input diode temperature coefficient (each channel)	$\Delta V_F / \Delta T_a$	$I_F = 10\text{mA}$	—	-2.0	—	mV / °C
Input reverse breakdown voltage (each channel)	$BV_R$	$I_R = 10\mu\text{A}$ , $T_a = 25^\circ\text{C}$	5	—	—	V
Input capacitance (each channel)	$C_T$	$V_F = 0$ , $f = 1\text{MHz}$	—	45	—	pF
High level output current (each channel)	$I_{OH}$	$V_{CC} = 5.5\text{V}$ , $V_O = 5.5\text{V}$ $I_F = 250\mu\text{A}$	—	1	250	$\mu\text{A}$
Low level output voltage (each channel)	$V_{OL}$	$V_{CC} = 5.5\text{V}$ , $I_F = 5\text{mA}$ $I_{OL}(\text{sinking}) = 13\text{mA}$	—	0.4	0.6	V
High level supply current (both channels)	$I_{CCH}$	$V_{CC} = 5.5\text{V}$ , $I_F = 0$	—	14	30	mA
Low level supply current (both channels)	$I_{CCL}$	$V_{CC} = 5.5\text{V}$ , $I_F = 10\text{mA}$	—	24	38	mA
Isolation voltage	$R_S$	$V_S = 500\text{V}$ , R.H. $\leq 60\%$ (Note 3)	$5 \times 10^{10}$	$10^{14}$	—	$\Omega$
Capacitance (input-output)	$C_S$	$f = 1\text{MHz}$ (Note 3)	—	0.6	—	pF
Input-input leakage current	$I_{I-I}$	R.H. $\leq 60\%$ , $t = 5\text{s}$ $V_{I-I} = 500\text{V}$ (Note 6)	—	0.005	—	$\mu\text{A}$
Resistance (input-input)	$R_{I-I}$	$V_{I-I} = 500\text{V}$ (Note 6)	—	$10^{11}$	—	$\Omega$
Capacitance (input-input)	$C_{I-I}$	$f = 1\text{MHz}$ (Note 6)	—	0.25	—	pF

\* All typical values are at  $V_{CC} = 5\text{V}$ ,  $T_a = 25^\circ\text{C}$ .

## Switching Characteristics (Ta = 25°C, VCC = 5V)

Characteristic	Symbol	Test Circuit	Test Condition	Min.	Typ.	Max.	Unit
Propagation delay time to low output level	t <sub>pHL</sub>	1	I <sub>F</sub> = 0 → 7.5mA, R <sub>L</sub> = 350Ω C <sub>L</sub> = 15pF (each channel)	—	60	75	ns
Propagation delay time to high output level	t <sub>pLH</sub>	1	I <sub>F</sub> = 7.5mA → 0, R <sub>L</sub> = 350Ω C <sub>L</sub> = 15pF (each channel)	—	60	75	ns
Output rise time, output fall time (10~90%)	t <sub>r</sub> , t <sub>f</sub>	1	I <sub>F</sub> = 0 ↔ 7.5mA, R <sub>L</sub> = 350Ω C <sub>L</sub> = 15pF (each channel)	—	30	—	ns
Common mode transient immunity at high output level	CM <sub>H</sub>	2	I <sub>F</sub> = 0, R <sub>L</sub> = 350Ω V <sub>CM</sub> = 400V, V <sub>O(min.)</sub> = 2V (each channel, Note 4)	1000	10000	—	V / μs
Common mode transient immunity at low output level	CM <sub>L</sub>	2	I <sub>F</sub> = 7.5mA, R <sub>L</sub> = 350Ω V <sub>CM</sub> = 400V V <sub>O(max.)</sub> = 0.8V (each channel, Note 5)	-1000	-10000	—	V / μs

(Note 1) 2mm below seating plane

(Note 2) The V<sub>CC</sub> supply voltage to each TLP2631 isolator must be bypassed by a 0.01μF capacitor or larger. This can be either a ceramic or solid tantalum capacitor with good high frequency characteristic and should be connected as close as possible to the package V<sub>CC</sub> and GND pins each device.

(Note 3) Device considered a two-terminal device: Pins 1, 2, 3 and 4 shorted together, and pins 5, 6, 7 and 8 shorted together.

(Note 4) CM<sub>H</sub>: the maximum tolerable rate of rise of the common mode voltage to ensure the output will remain in the high state (i.e., V<sub>OUT</sub> > 2.0V).

Measured in volts per microsecond (V / μs).

Volts/ microsecond can be translated to sinusoidal voltages:

$$V / \mu s = \frac{(dV_{CM})}{dt} \text{Max.} = f_{CM} V_{CM(p.p.)}$$

Example:

$$V_{CM} = 319V_{pp} \text{ when } f_{CM} = 1\text{MHz using } CM_L \text{ and } CM_H = 1000V / \mu s \text{ data sheet specified minimum.}$$

(Note 5) CM<sub>L</sub>: the maximum tolerable rate of fall of the common mode voltage to ensure the output will remain in the low output state (i.e., V<sub>OUT</sub> > 0.8V).

Measured in volts per microsecond (V / μs).

(Note 6) Measured between pins 1 and 2 shorted together, and pins 3 and 4 shorted together.

**Test Circuit 1.  $t_{pHL}$  and  $t_{pLH}$**

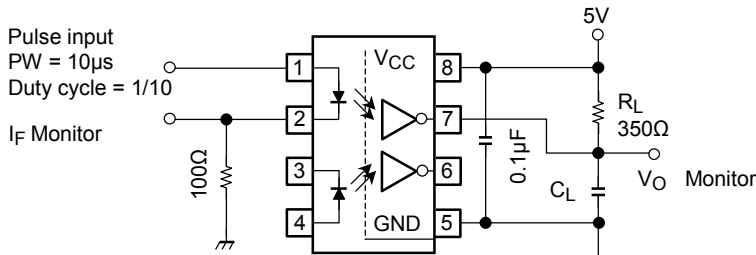

\*  $C_L$  is approximately 15pF which includes probe and stray wiring capacitance.

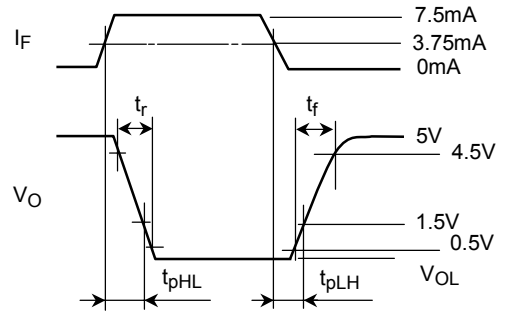

**Test Circuit 2. Transient Immunity And Typical Waveforms.**

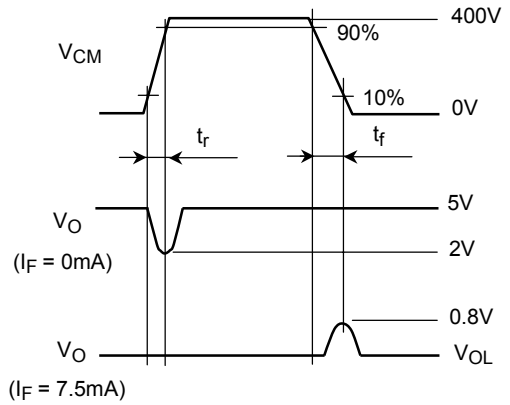
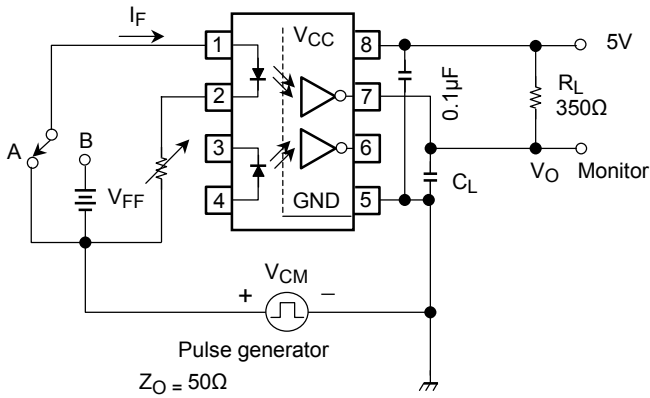

$$CM_H = \frac{320(V)}{t_r(\mu s)}, CM_L = \frac{320(V)}{t_f(\mu s)}$$

\*  $C_L$  is approximately 15pF which includes probe and stray wiring capacitance.

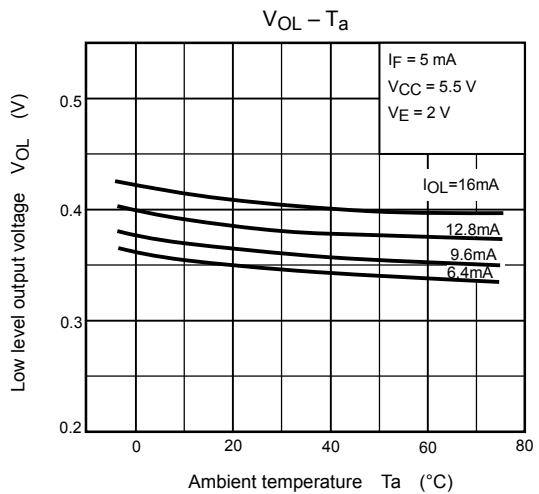
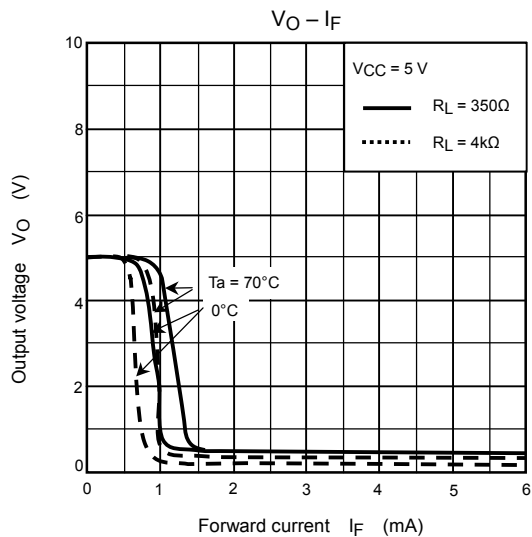
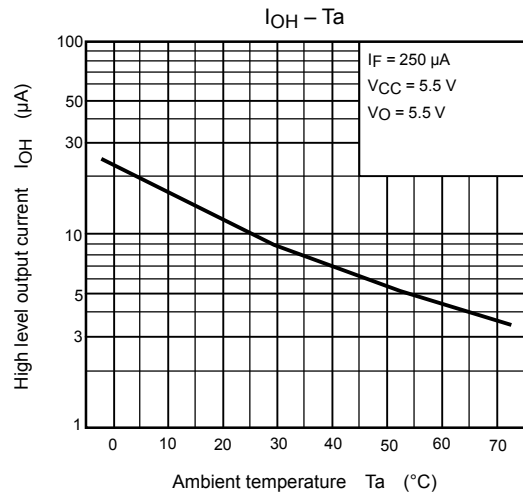
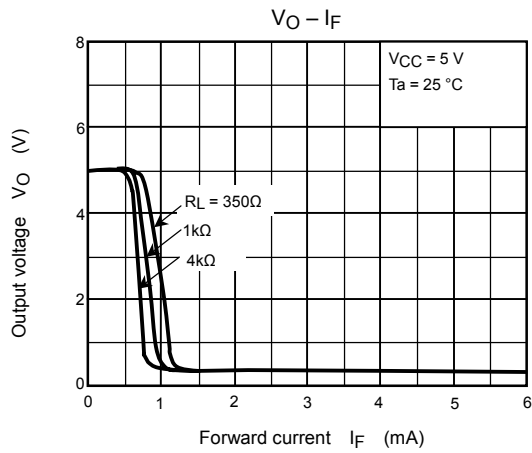
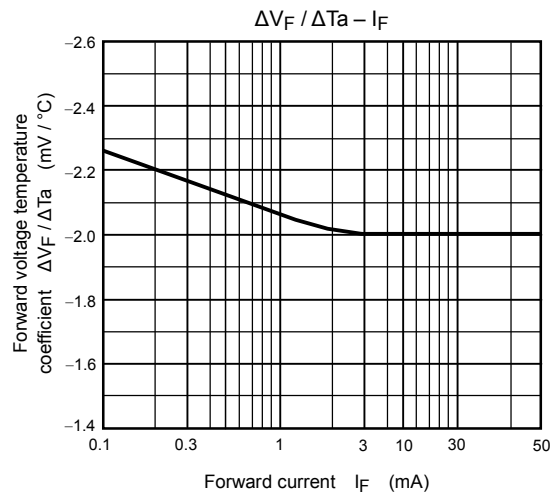
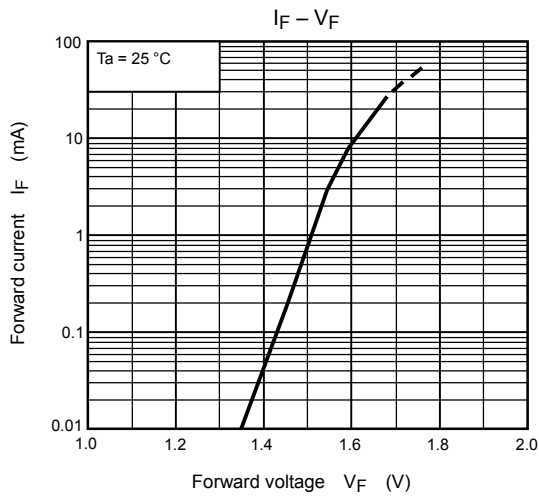

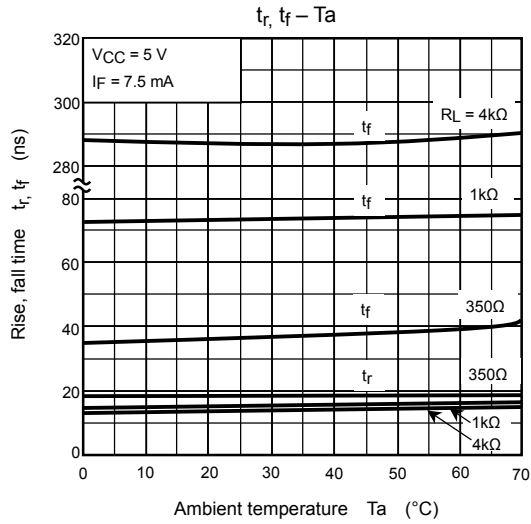
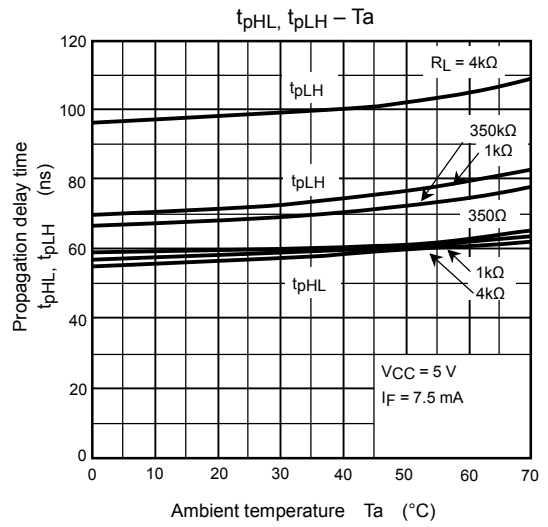
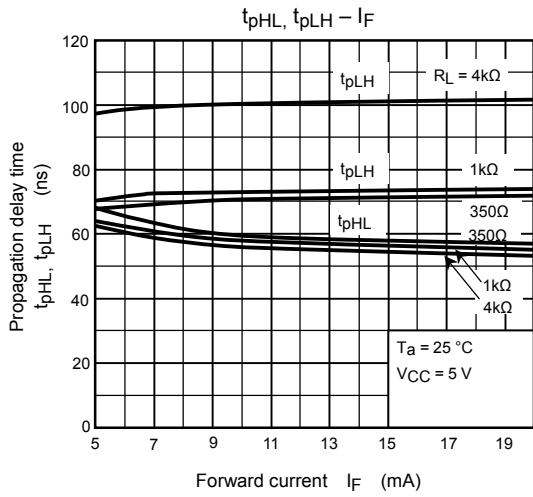

**RESTRICTIONS ON PRODUCT USE**

000707EBC

- TOSHIBA is continually working to improve the quality and reliability of its products. Nevertheless, semiconductor devices in general can malfunction or fail due to their inherent electrical sensitivity and vulnerability to physical stress. It is the responsibility of the buyer, when utilizing TOSHIBA products, to comply with the standards of safety in making a safe design for the entire system, and to avoid situations in which a malfunction or failure of such TOSHIBA products could cause loss of human life, bodily injury or damage to property.  
In developing your designs, please ensure that TOSHIBA products are used within specified operating ranges as set forth in the most recent TOSHIBA products specifications. Also, please keep in mind the precautions and conditions set forth in the "Handling Guide for Semiconductor Devices," or "TOSHIBA Semiconductor Reliability Handbook" etc..
- The TOSHIBA products listed in this document are intended for usage in general electronics applications (computer, personal equipment, office equipment, measuring equipment, industrial robotics, domestic appliances, etc.). These TOSHIBA products are neither intended nor warranted for usage in equipment that requires extraordinarily high quality and/or reliability or a malfunction or failure of which may cause loss of human life or bodily injury ("Unintended Usage"). Unintended Usage include atomic energy control instruments, airplane or spaceship instruments, transportation instruments, traffic signal instruments, combustion control instruments, medical instruments, all types of safety devices, etc.. Unintended Usage of TOSHIBA products listed in this document shall be made at the customer's own risk.
- Gallium arsenide (GaAs) is a substance used in the products described in this document. GaAs dust and fumes are toxic. Do not break, cut or pulverize the product, or use chemicals to dissolve them. When disposing of the products, follow the appropriate regulations. Do not dispose of the products with other industrial waste or with domestic garbage.
- The products described in this document are subject to the foreign exchange and foreign trade laws.
- The information contained herein is presented only as a guide for the applications of our products. No responsibility is assumed by TOSHIBA CORPORATION for any infringements of intellectual property or other rights of the third parties which may result from its use. No license is granted by implication or otherwise under any intellectual property or other rights of TOSHIBA CORPORATION or others.
- The information contained herein is subject to change without notice.