

TLP200D

PBX

MODEM · FAX CARD

MEASUREMENT INSTRUMENT

The TOSHIBA TLP200D consists of gallium arsenide infrared emitting diode optically coupled to a photo-MOS FET in a 8 pin SOP.

The TLP200D is a 2-Form-A switch which is suitable for replacement of mechanical relays in many applications which require space savings.

- SOP 8 pin (2.54SOP8) : 2-Form-A
- Peak Off-State Voltage : 200 V (MIN.)
- Trigger LED Current : 3 mA (MAX.)
- On-State Current : 200 mA (MAX.)
- On-State Resistance : 8 Ω (MAX.)
- Isolation Voltage : 1500 V_{rms} (MIN.)
- UL Recognized : UL1577, File No. E67349

Unit in mm

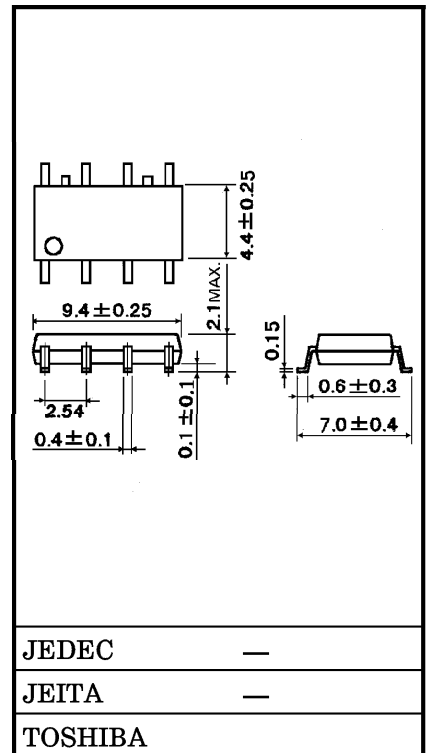

Weight : 0.2 g

SCHEMATIC

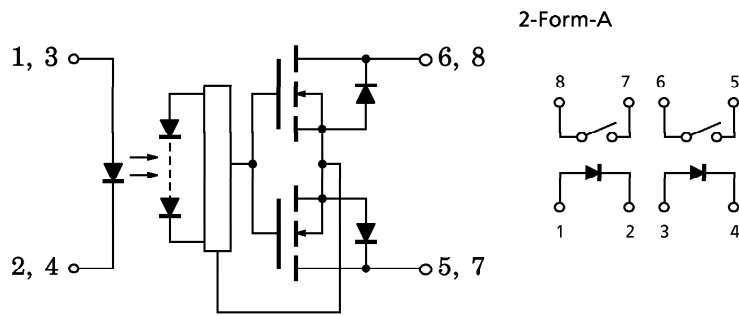

PIN CONFIGURATION (TOP VIEW)

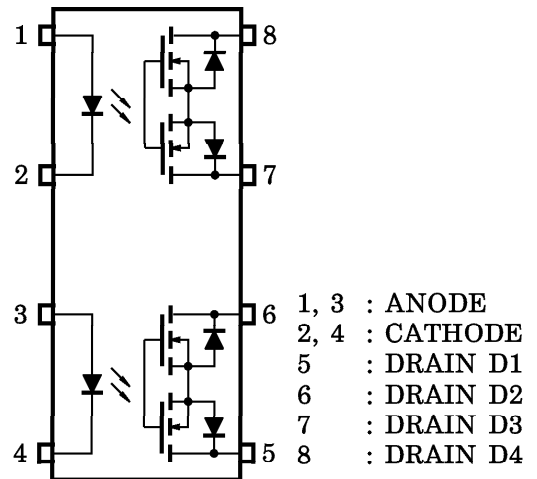

MAXIMUM RATINGS (Ta = 25°C)

CHARACTERISTIC		SYMBOL	RATING	UNIT
LED	Forward Current	I _F	50	mA
	Forward Current Derating (Ta ≥ 25°C)	ΔI _F /°C	-0.5	mA/°C
	Pulse Forward Current (100 μs pulse, 100 pps)	I _{FP}	1	A
	Reverse Voltage	V _R	5	V
	Junction Temperature	T _j	125	°C
DETECTOR	Off-State Output Terminal Voltage	V _{OFF}	200	V
	On-State Current	I _{ON}	200	mA
	On-State RMS Current Derating (Ta ≥ 25°C)	ΔI _{ON} /°C	-2.0	mA/°C
	Junction Temperature	T _j	125	°C
Storage Temperature Range		T _{stg}	-55~125	°C
Operating Temperature Range		T _{opr}	-40~85	°C
Lead Soldering Temperature (10 s)		T _{sol}	260	°C
Isolation Voltage (AC, 1 min., R.H. ≤ 60%) (Note 2)		BV _S	1500	V _{rms}

(Note 1) : Two channels operating simultaneously.

(Note 2) : Device considered a two-terminal device : pins 1, 2, 3 and 4 shorted together and pins 5, 6, 7 and 8 shorted together.

RECOMMENDED OPERATING CONDITIONS

CHARACTERISTIC	SYMBOL	MIN.	TYP.	MAX.	UNIT
Supply Voltage	V _{DD}	—	150	200	V
Forward Current	I _F	5	7.5	25	mA
On-State Current	I _{ON}	—	—	130	mA
Operating Temperature	T _{opr}	-20	—	65	°C

INDIVIDUAL ELECTRICAL CHARACTERISTICS (Ta = 25°C)

CHARACTERISTIC		SYMBOL	TEST CONDITION	MIN.	TYP.	MAX.	UNIT
LED	Forward Voltage	V_F	$I_F = 10 \text{ mA}$	1.0	1.15	1.3	V
	Reverse Current	I_R	$V_R = 5 \text{ V}$	—	—	10	μA
	Capacitance	C_T	$V = 0, f = 1 \text{ MHz}$	—	30	—	pF
DETECTOR	Off-State Current	I_{OFF}	$V_{OFF} = 200 \text{ V}$	—	—	1	μA
	Capacitance	C_{OFF}	$V = 0, f = 1 \text{ MHz}$	—	100	—	pF

COUPLED ELECTRICAL CHARACTERISTICS (Ta = 25°C)

CHARACTERISTIC	SYMBOL	TEST CONDITION	MIN.	TYP.	MAX.	UNIT
Trigger LED Current	I_{FT}	$I_{ON} = 200 \text{ mA}$	—	1	3	mA
On-State Resistance	R_{ON}	$I_{ON} = 200 \text{ mA}, I_F = 5 \text{ mA}$	—	5	8	Ω

ISOLATION CHARACTERISTICS (Ta = 25°C)

CHARACTERISTIC	SYMBOL	TEST CONDITION	MIN.	TYP.	MAX.	UNIT
Capacitance Input to Output	C_S	$V_S = 0, f = 1 \text{ MHz}$	—	0.8	—	pF
Isolation Resistance	R_S	$V_S = 500 \text{ V}, \text{R.H.} \leq 60\%$	5×10^{10}	10^{14}	—	Ω
Isolation Voltage	BV_S	AC, 1 minute	1500	—	—	V_{rms}
		AC, 1 second, in oil	—	3000	—	
		DC, 1 minute, in oil	—	3000	—	Vdc

SWITCHING CHARACTERISTICS (Ta = 25°C)

CHARACTERISTIC	SYMBOL	TEST CONDITION	MIN.	TYP.	MAX.	UNIT
Turn-on Time	t_{ON}	$R_L = 200 \Omega$ (Note 3)	—	0.6	1.5	ms
Turn-off Time	t_{OFF}	$V_{DD} = 20 \text{ V}, I_F = 5 \text{ mA}$	—	0.1	1.0	

(Note 3) : Switching Time Test Circuit

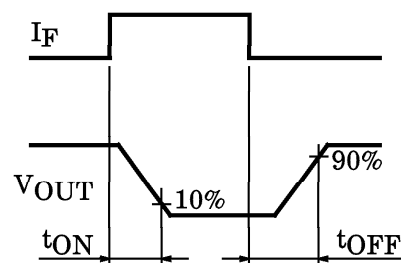
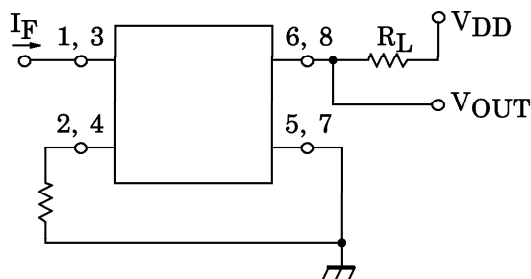

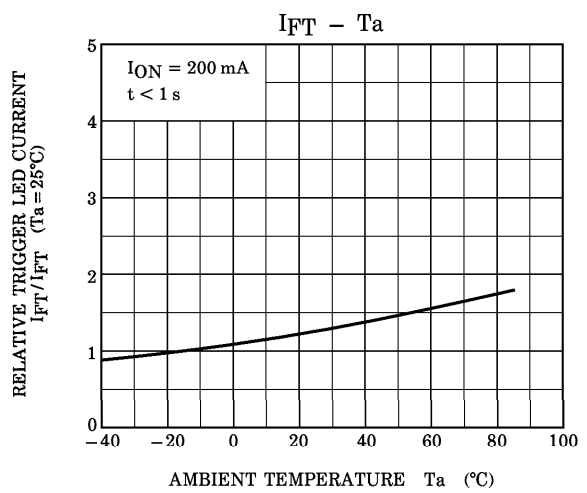
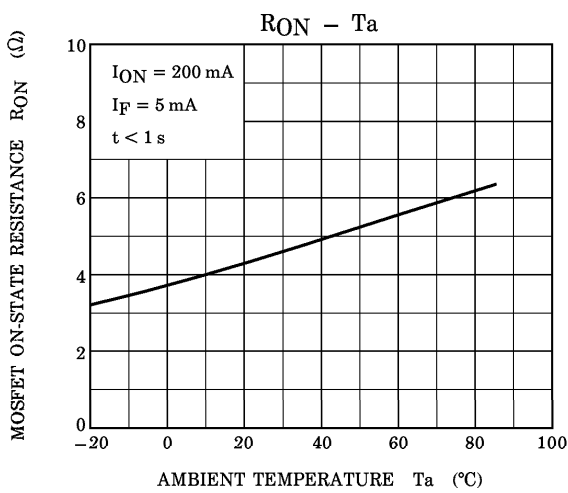
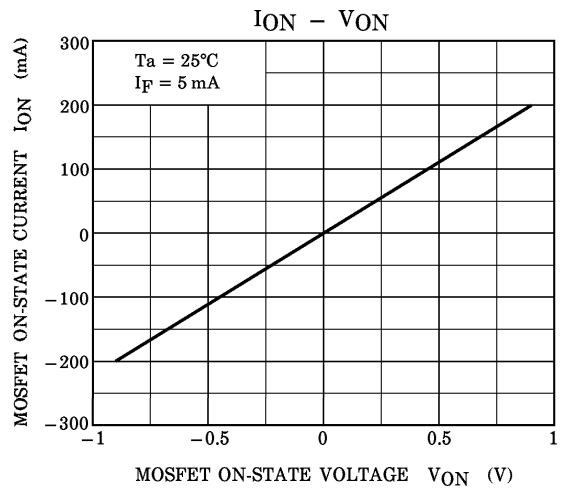
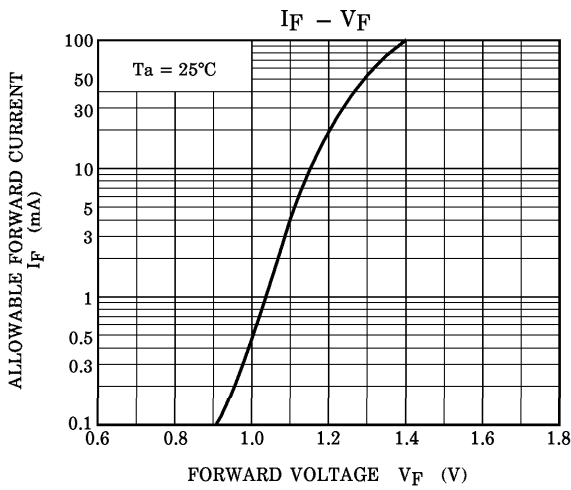
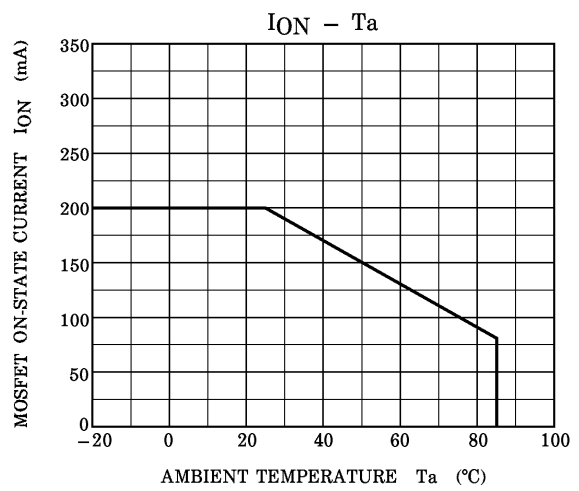
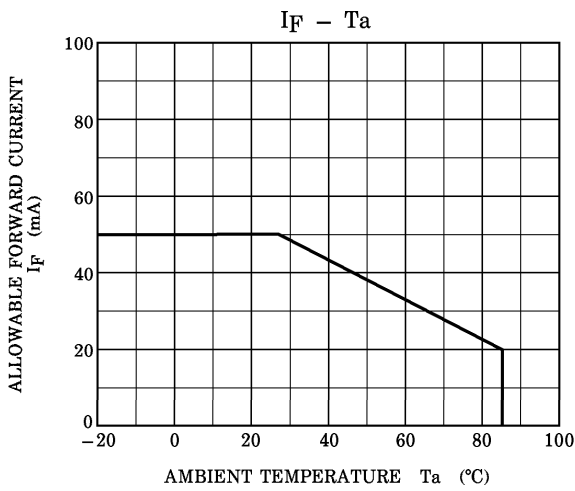

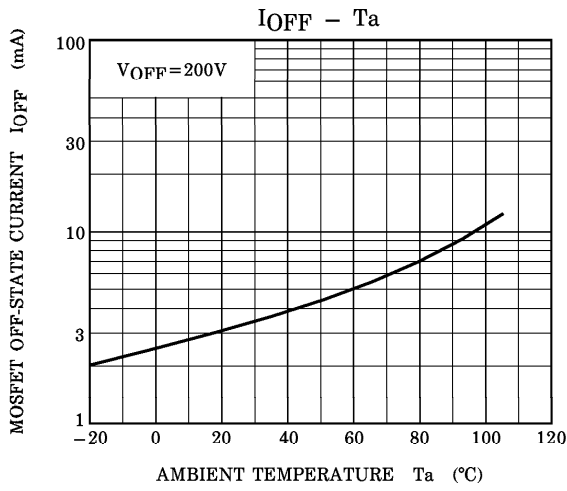
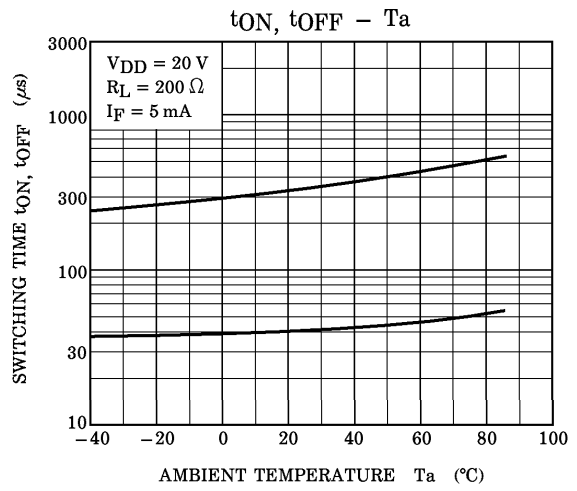
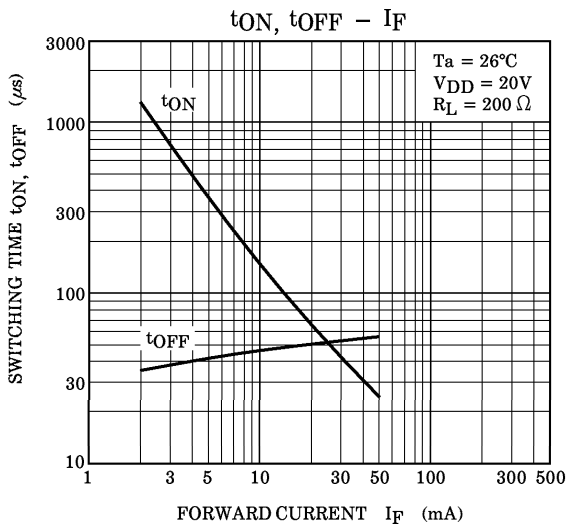

RESTRICTIONS ON PRODUCT USE

020704EBC

- TOSHIBA is continually working to improve the quality and reliability of its products. Nevertheless, semiconductor devices in general can malfunction or fail due to their inherent electrical sensitivity and vulnerability to physical stress. It is the responsibility of the buyer, when utilizing TOSHIBA products, to comply with the standards of safety in making a safe design for the entire system, and to avoid situations in which a malfunction or failure of such TOSHIBA products could cause loss of human life, bodily injury or damage to property. In developing your designs, please ensure that TOSHIBA products are used within specified operating ranges as set forth in the most recent TOSHIBA products specifications. Also, please keep in mind the precautions and conditions set forth in the "Handling Guide for Semiconductor Devices," or "TOSHIBA Semiconductor Reliability Handbook" etc..
- The TOSHIBA products listed in this document are intended for usage in general electronics applications (computer, personal equipment, office equipment, measuring equipment, industrial robotics, domestic appliances, etc.). These TOSHIBA products are neither intended nor warranted for usage in equipment that requires extraordinarily high quality and/or reliability or a malfunction or failure of which may cause loss of human life or bodily injury ("Unintended Usage"). Unintended Usage include atomic energy control instruments, airplane or spaceship instruments, transportation instruments, traffic signal instruments, combustion control instruments, medical instruments, all types of safety devices, etc.. Unintended Usage of TOSHIBA products listed in this document shall be made at the customer's own risk.
- GaAs (Gallium Arsenide) is a substance used in the products described in this document. GaAs dust or vapor is harmful to the human body. Do not break, cut, crush or dissolve chemically.
- The products described in this document are subject to the foreign exchange and foreign trade laws.
- The information contained herein is presented only as a guide for the applications of our products. No responsibility is assumed by TOSHIBA CORPORATION for any infringements of intellectual property or other rights of the third parties which may result from its use. No license is granted by implication or otherwise under any intellectual property or other rights of TOSHIBA CORPORATION or others.
- The information contained herein is subject to change without notice.