

S202SE1/S202SE2

S216SE1/S216SE2

■ Features

- Comforms to European Safety Standard (EN60950)
(Need of the insulation sheet when mounting external heat sink)
Internal insulation distance : 0.4mm or more
Creepage distance : 5mm or more
Space distance : 4mm or more
- RMS ON-state current
S202SE1 / S202SE2 : 8Arms at $T_c \leq 80^\circ\text{C}$
(with heat sink)
S216SE1 / S216SE2 : 16Arms at $T_c \leq 60^\circ\text{C}$
(with heat sink)
- Isolation voltage between input and output (V_{iso} : 3 000V_{rms})
- Approved by TÜV, No. R9051479
- Recognized by UL, No. E94758
(S202SE1 / S202SE2)
Approved by CSA, No. LR63705
(S202SE1, S202SE2)

■ Applications

- Copiers
- Laser beam printers

■ Line-up

	RMS ON-state current	
	MAX. 8Arms	MAX. 16Arms
No built-in Zero-cross circuit	S202SE1	S216SE1
Built-in Zero-cross circuit	S202SE2	S216SE2

■ Absolute Maximum Ratings

Parameter	Symbol	Rating		Unit
		S202SE1/S202SE2	S216SE1/S216SE2	
Input	Forward current	I_F	50	mA
	Reverse voltage	V_R	6	V
	RMS ON-state current	I_T	*48	A _{rms}
	*1 Peak one cycle surge current	I_{surge}	80	A
Output	Repetitive peak OFF-state voltage	V_{DRM}	600	V
	Non-repetitive peak OFF-state voltage	V_{DSM}	600	V
	Critical rate of rise of ON-state current	dI_T/dt	50	A/ μs
	Operating frequency	f	45 to 65	Hz
	*2 Isolation voltage	V_{iso}	3,000	V _{rms}
	Operating temperature	T_{opr}	- 25 to + 100	$^\circ\text{C}$
	Storage temperature	T_{stg}	- 30 to + 125	$^\circ\text{C}$
	*3 Soldering temperature	T_{sol}	260	$^\circ\text{C}$

*1 60Hz sine wave, $T_j = 25^\circ\text{C}$ start

*2 AC 60Hz for 1 minute, 40 to 60% RH, Apply voltages between input and output by the dielectric withstand voltage tester with zero-cross circuit.(Input and output shall be shorted respectively).

(Note) When the isolation voltage is necessary at using external heat sink, please use the insulation sheet.

*3 For 10 seconds *4 $T_c \leq 80^\circ\text{C}$ *5 $T_c \leq 60^\circ\text{C}$

SIP Type SSR for Medium Power Control

■ Outline Dimensions

(Unit : mm)

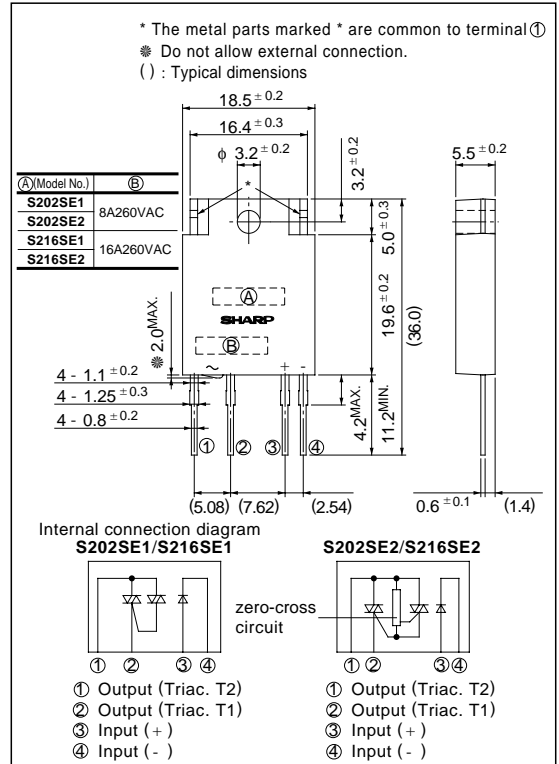

($T_a = 25^\circ\text{C}$)

Electrical Characteristics

(Ta = 25°C)

Parameter		Symbol	Conditions	MIN.	TYP.	MAX.	Unit	
Input	Forward voltage	V_F	$I_F = 20\text{mA}$	-	1.2	1.4	V	
	Reverse current	I_R	$V_R = 3\text{V}$	-	-	10^{-4}	A	
Repetitive peak OFF-state current		I_{DRM}	$V_D = V_{DRM}$	-	-	10^{-4}	A	
Output	ON-state voltage	V_T	$I_T = 2A_{rms}$	-	-	1.5	V_{rms}	
			$I_T = 16A_{rms}$	-	-	1.5		
	Holding current		I_H	-	-	-	50	mA
	Critical rate of rise of OFF-state voltage		dV/dt	$V_D = 2/3V_{DRM}$	30	-	-	$V/\mu s$
	Critical rate of rise of commutating OFF-state voltage		$(dV/dt)_c$	$T_j = 125^\circ\text{C}, V_D = 400\text{V} *6$	5	-	-	$V/\mu s$
	Zero-cross voltage	S202SE2/S216SE2	V_{OX}	$I_F = 8\text{mA}$	-	-	35	V
Transfer characteristics	Minimum trigger current	I_{FT}	S202SE1/S216SE1	$V_D = 12\text{V}, R_L = 30\Omega$	-	-	8	mA
			S202SE2/S216SE2	$V_D = 6\text{V}, R_L = 30\Omega$	-	-	8	
			Isolation resistance		R_{ISO}	DC500V, 40 to 60 % RH	10^{10}	
	Turn-on time	t_{on}	S202SE1/S216SE1	AC60Hz	-	-	1	ms
			S202SE2/S216SE2		-	-	9.3	
	Turn-off time		t_{off}	AC60Hz	-	-	9.3	ms
Thermal resistance (Between junction and case)		$R_{th(j-c)}$	-	-	-	4.5	-	$^\circ\text{C/W}$
					S216SE1/S216SE2	-	3.3	
Thermal resistance (Between junction and ambience)		$R_{th(j-a)}$	-	-	-	40	-	$^\circ\text{C/W}$

*6 $dI_T/dt = -4.0\text{A/ms}$ (**S202SE1/S202SE2**) $dI_T/dt = -8.0\text{A/ms}$ (**S216SE1/S216SE2**)

Fig.1-a RMS ON-state Current vs. Ambient Temperature
(S202SE1/ S202SE2)

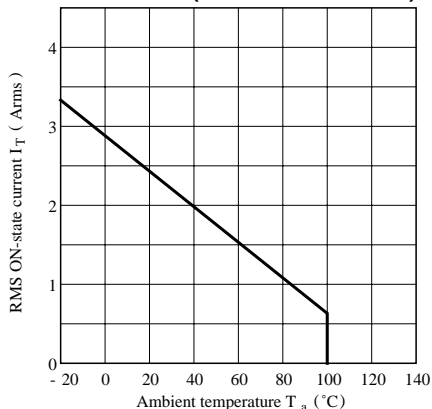

Fig.1-b RMS ON-state Current vs. Ambient Temperature
(S216SE1/ S216SE2)

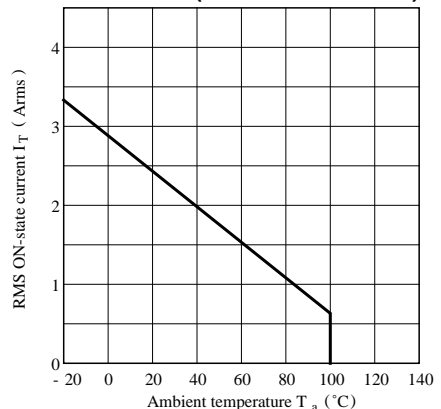

Fig.2-a RMS ON-state Current vs. Case Temperature (S202SE1/ S202SE2)

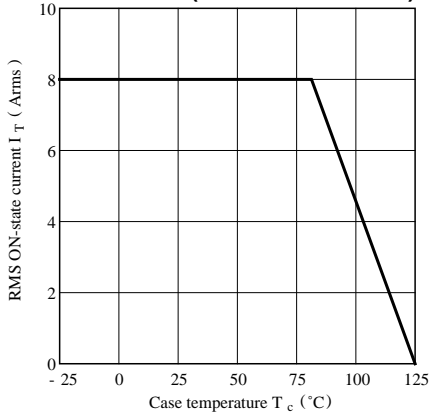

Fig.2-b RMS ON-state Current vs. Case Temperature (S216SE1/ S216SE2)

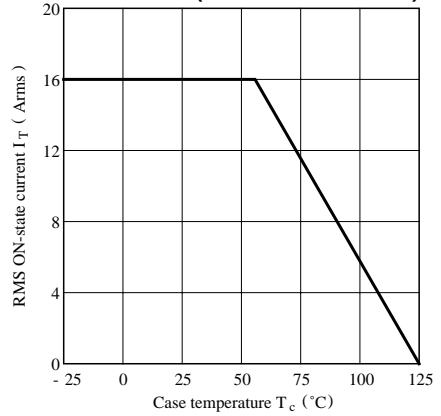

Fig. 3 Forward Current vs. Ambient Temperature

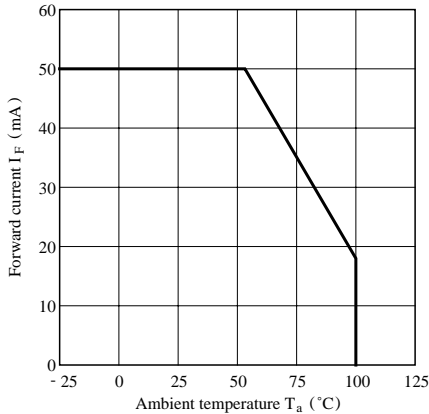

Fig. 4 Forward Current vs. Forward Voltage

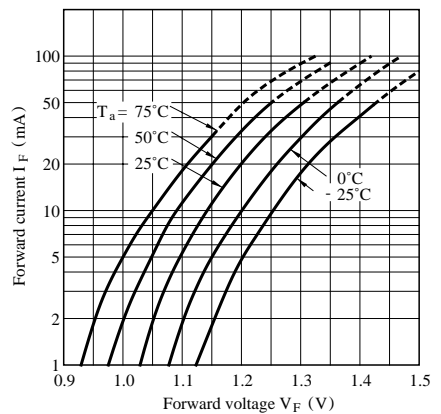

Fig.5-a Surge Current vs. Power-ON Cycle (S202SE1/ S202SE2)

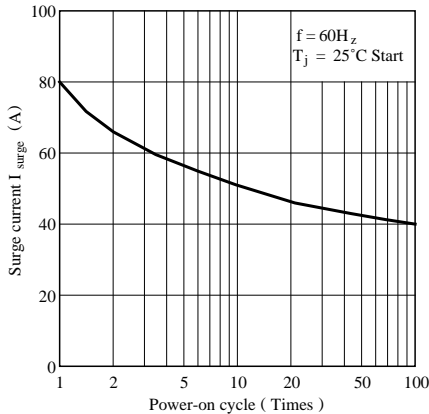

Fig.5-b Surge Current vs. Power-ON Cycle (S216SE1/ S216SE2)

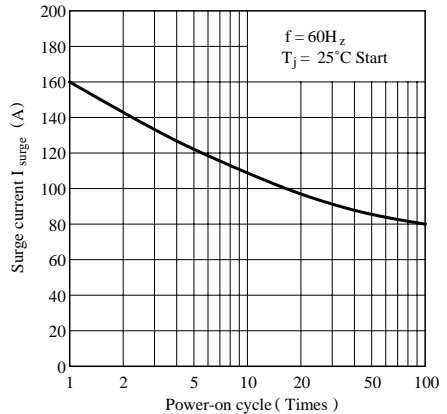

Fig.6-a Maximum ON-State Power Dissipation vs. RMS ON-State Current (S202SE1 / S202SE2)

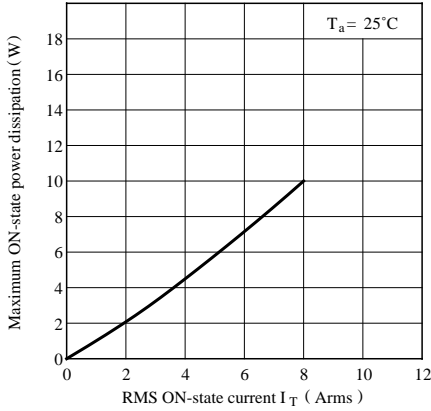

Fig.6-b Maximum ON-State Power Dissipation vs. RMS ON-State Current (S216SE1 / S216SE2)

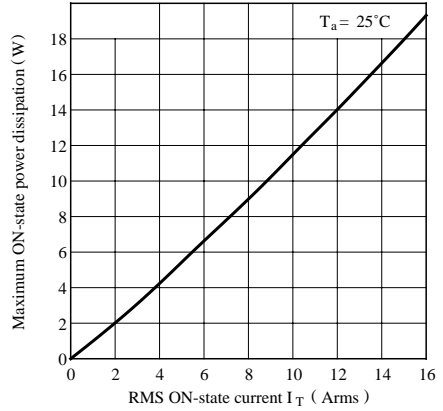

Fig.7-a Minimum Trigger Current vs. Ambient Temperature (Typical Value) (S202SE1 / S216SE1)

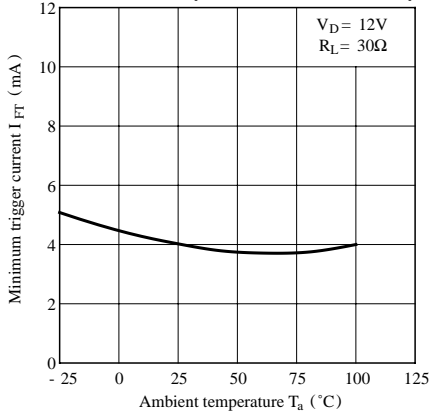

Fig.7-b Minimum Trigger Current vs. Ambient Temperature (Typical Value) (S202SE2 / S216SE2)

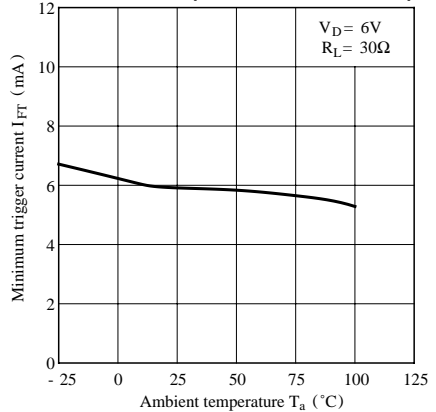

Fig.8-a Repetitive Peak OFF-state Current vs. Ambient Temperature (Typical Value) (S202SE1 / S202SE2)

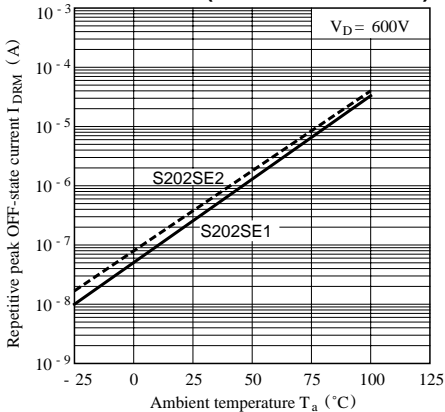
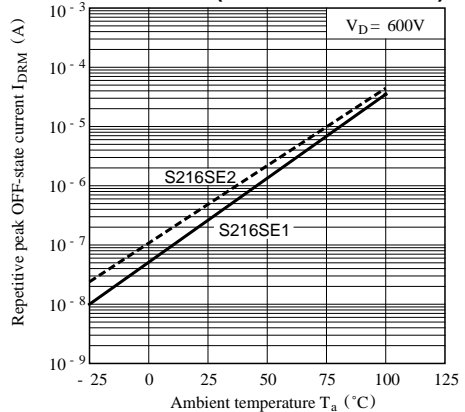

Fig.8-b Repetitive Peak OFF-state Current vs. Ambient Temperature (Typical Value) (S216SE1 / S216SE2)



NOTICE

- The circuit application examples in this publication are provided to explain representative applications of SHARP devices and are not intended to guarantee any circuit design or license any intellectual property rights. SHARP takes no responsibility for any problems related to any intellectual property right of a third party resulting from the use of SHARP's devices.
- Contact SHARP in order to obtain the latest device specification sheets before using any SHARP device. SHARP reserves the right to make changes in the specifications, characteristics, data, materials, structure, and other contents described herein at any time without notice in order to improve design or reliability. Manufacturing locations are also subject to change without notice.
- Observe the following points when using any devices in this publication. SHARP takes no responsibility for damage caused by improper use of the devices which does not meet the conditions and absolute maximum ratings to be used specified in the relevant specification sheet nor meet the following conditions:
 - (i) The devices in this publication are designed for use in general electronic equipment designs such as:
 - Personal computers
 - Office automation equipment
 - Telecommunication equipment [terminal]
 - Test and measurement equipment
 - Industrial control
 - Audio visual equipment
 - Consumer electronics
 - (ii) Measures such as fail-safe function and redundant design should be taken to ensure reliability and safety when SHARP devices are used for or in connection with equipment that requires higher reliability such as:
 - Transportation control and safety equipment (i.e., aircraft, trains, automobiles, etc.)
 - Traffic signals
 - Gas leakage sensor breakers
 - Alarm equipment
 - Various safety devices, etc.
 - (iii) SHARP devices shall not be used for or in connection with equipment that requires an extremely high level of reliability and safety such as:
 - Space applications
 - Telecommunication equipment [trunk lines]
 - Nuclear power control equipment
 - Medical and other life support equipment (e.g., scuba).
- Contact a SHARP representative in advance when intending to use SHARP devices for any "specific" applications other than those recommended by SHARP or when it is unclear which category mentioned above controls the intended use.
- If the SHARP devices listed in this publication fall within the scope of strategic products described in the Foreign Exchange and Foreign Trade Control Law of Japan, it is necessary to obtain approval to export such SHARP devices.
- This publication is the proprietary product of SHARP and is copyrighted, with all rights reserved. Under the copyright laws, no part of this publication may be reproduced or transmitted in any form or by any means, electronic or mechanical, for any purpose, in whole or in part, without the express written permission of SHARP. Express written permission is also required before any use of this publication may be made by a third party.
- Contact and consult with a SHARP representative if there are any questions about the contents of this publication.