

# PR26MF11NSZ Series/ PR36MF11NSZ Series

## ■ Features

1. Compact 8-pin dual-in-line package type
2. RMS ON-state current  $I_{T(rms)}$ :0.6A
3. Built-in zero-cross circuit  
**(PR26MF21NSZ/PR36MF21NSZ)**
4. High repetitive peak OFF-state voltage  
**PR26MF11NSZ/PR26MF21NSZ**  $V_{DRM}$ :MIN. 400V  
**PR36MF11NSZ/PR36MF21NSZ**  $V_{DRM}$ :MIN. 600V
5. Isolation voltage between input and output  
( $V_{iso(rms)}$ ):4kV)
6. Recognized by UL (No. E94758)
7. Recognized by CSA (No. LR63705)
8. VDE (VDE0884) approved type  
**(PR36MF11YSZ, PR36MF21YSZ)** is also available as an option

## ■ Applications

1. Various types of home appliances

## ■ Absolute Maximum Ratings (T<sub>a</sub>=25°C)

Parameter		Symbol	Rating	Unit	
Input	*1 Forward current	$I_F$	50	mA	
	Reverse voltage	$V_R$	6	V	
Output	*1 RMS ON-state current	$I_{T(rms)}$	0.6	A	
	Peak one cycle surge current	$I_{surge}$	6 (50Hz sine wave)	A	
	Repetitive peak OFF-state voltage	PR26MF11NSZ	$V_{DRM}$	400	V
		PR26MF21NSZ			
		PR36MF11NSZ			
PR36MF21NSZ					
*2 Isolation voltage	$V_{iso(rms)}$	4.0	kV		
Operating temperature	PR26MF11NSZ	$T_{opr}$	-25 to +85	°C	
	PR36MF11NSZ				
	PR26MF21NSZ				
	PR36MF21NSZ				
Storage temperature	$T_{stg}$	-40 to +125	°C		
Soldering temperature	$T_{sol}$	260 (For 10s)	°C		

\*1 The derating factors of absolute maximum ratings due to ambient temperature are shown in Fig.1, 2, 3, 4

\*2 40 to 60%RH, AC for 1 minute, f=60Hz

## 8-Pin DIP Type SSR for Low Power Control

## ■ Outline Dimensions

(Unit : mm)

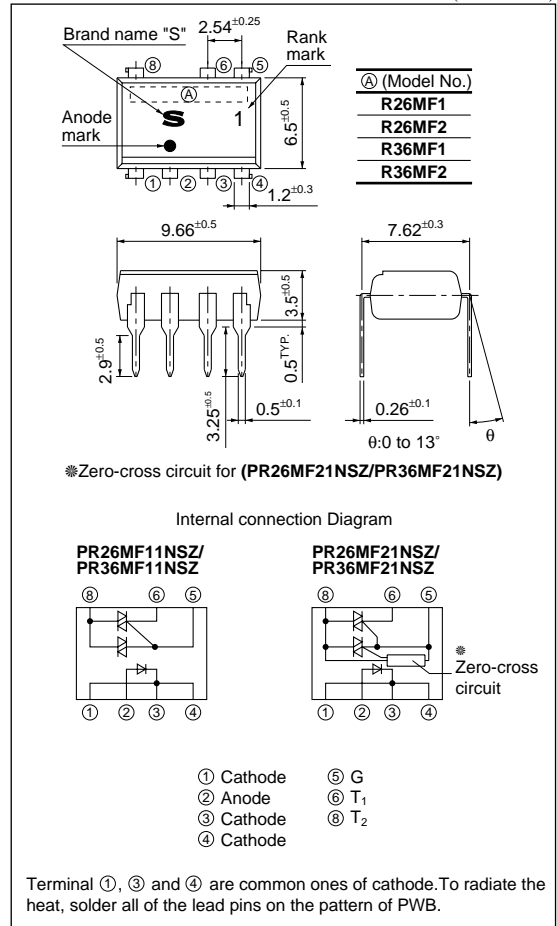

## ■ Model Line-up

	For 100V line	For 200V line
No built-in zero-cross circuit	PR26MF11NSZ	PR36MF11NSZ ※(PR36MF11YSZ)
Built-in zero-cross circuit	PR26MF21NSZ	PR36MF21NSZ ※(PR36MF21YSZ)

\* VDE (VDE0884) approved type

**■ Electrical Characteristics**

( $T_a=25^{\circ}\text{C}$ )

Parameter		Symbol	Conditions	MIN.	TYP.	MAX.	Unit	
Input	Forward voltage	$V_F$	$I_F=20\text{mA}$	—	1.2	1.4	V	
	Reverse current	$I_R$	$V_R=3\text{V}$	—	—	10	$\mu\text{A}$	
Output	Repetitive peak OFF-state current	$I_{\text{DRM}}$	$V_D=V_{\text{DRM}}$	—	—	100	$\mu\text{A}$	
	ON-state voltage	$V_T$	$I_T=0.6\text{A}$	—	—	3.0	V	
	Holding current	$I_H$	$V_D=6\text{V}$	—	—	25	mA	
	Critical rate of rise of OFF-state voltage	dV/dt	$V_D=1/\sqrt{2} \cdot V_{\text{DRM}}$	100	—	—	V/ $\mu\text{s}$	
	Zero-cross voltage	<b>PR26MF21NSZ</b>	$V_{\text{OX}}$	$I_F=15\text{mA}$ , R load	—	—	35	V
		<b>PR36MF21NSZ</b>						
Transfer characteristics	Minimum trigger current	$I_{\text{FT}}$	$V_D=6\text{V}$ , $R_L=100\Omega$	—	—	10	mA	
	Isolation resistance	$R_{\text{ISO}}$	DC=500V, 40 to 60%RH	$5 \times 10^{10}$	$10^{11}$	—	$\Omega$	
	Turn-on time	<b>PR26MF11NSZ/PR36MF11NSZ</b>	$t_{\text{on}}$	$V_D=6\text{V}$ , $R_L=100\Omega$ , $I_F=20\text{mA}$	—	—	100	$\mu\text{s}$
<b>PR26MF21NSZ/PR36MF21NSZ</b>		50						

**Fig.1 RMS ON-state Current vs. Ambient Temperature (PR26MF11NSZ/PR36MF11NSZ)**

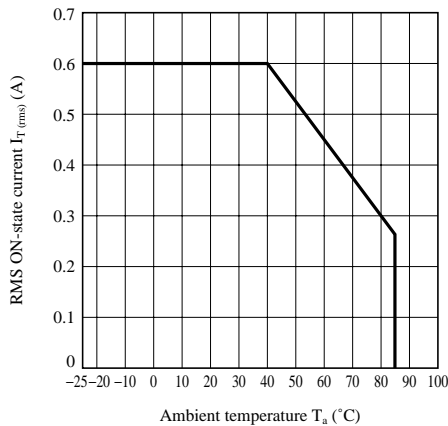

**Fig.2 RMS ON-state Current vs. Ambient Temperature (PR26MF21NSZ/PR36MF21NSZ)**

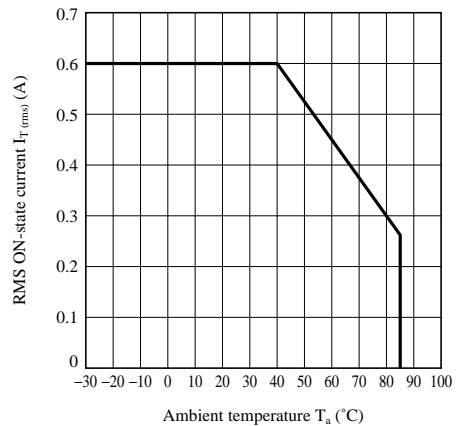

**Fig.3 Forward Current vs. Ambient Temperature (PR26MF11NSZ/PR36MF11NSZ)**

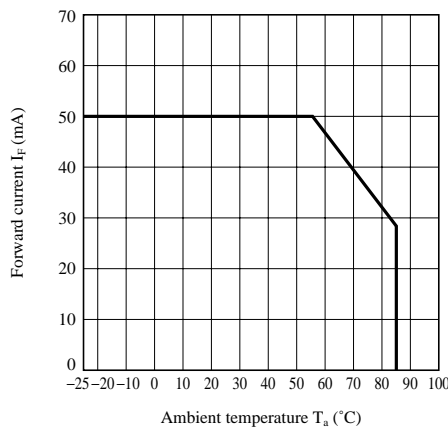

**Fig.4 Forward Current vs. Ambient Temperature (PR26MF21NSZ/PR36MF21NSZ)**

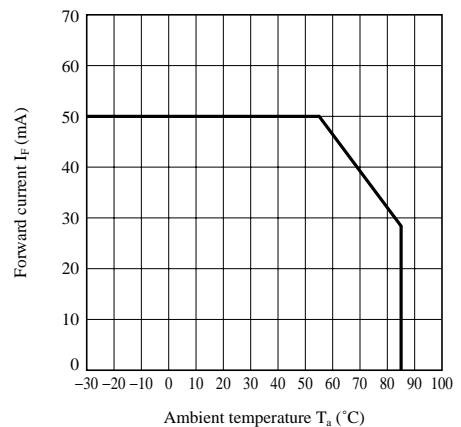

Fig.5 Forward Current vs. Forward Voltage

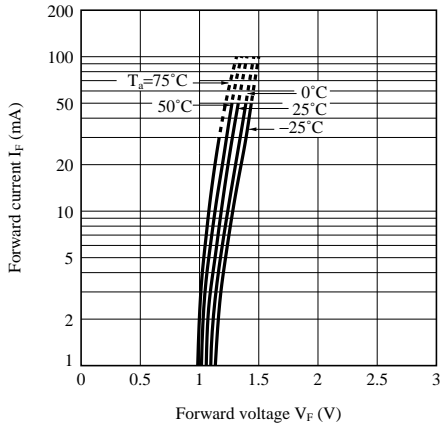

Fig.6 Minimum Trigger Current vs. Ambient Temperature

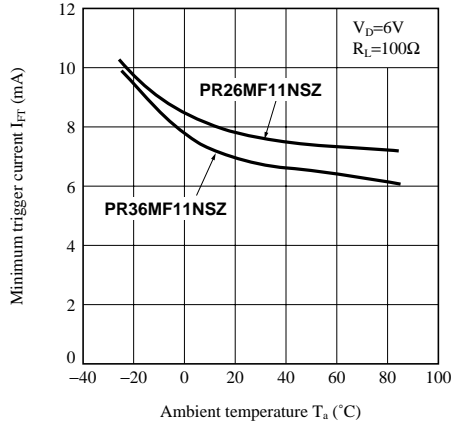

Fig.7 Minimum Trigger Current vs. Ambient Temperature (PR26MF21NSZ/PR36MF21NSZ)

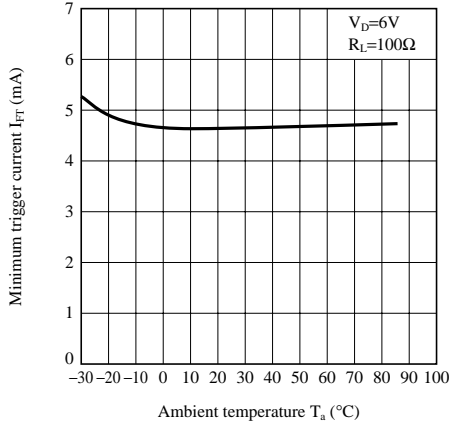

Fig.8 ON-state Voltage vs. Ambient Temperature (PR26MF11NSZ/PR36MF11NSZ)

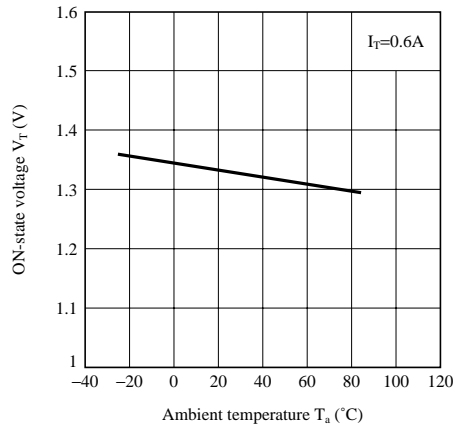

Fig.9 ON-state Voltage vs. Ambient Temperature (PR26MF21NSZ/PR36MF21NSZ)

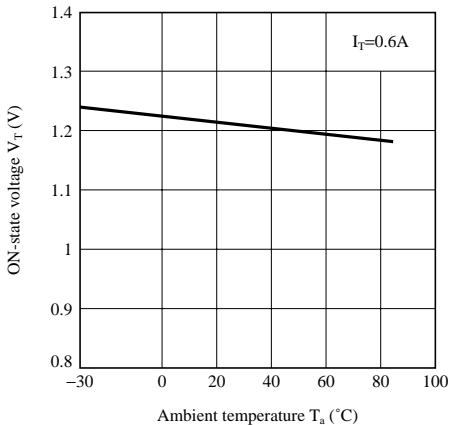
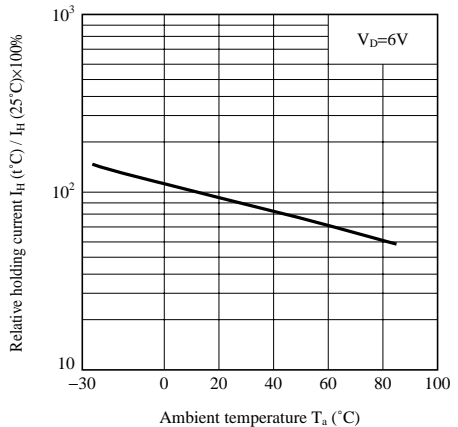
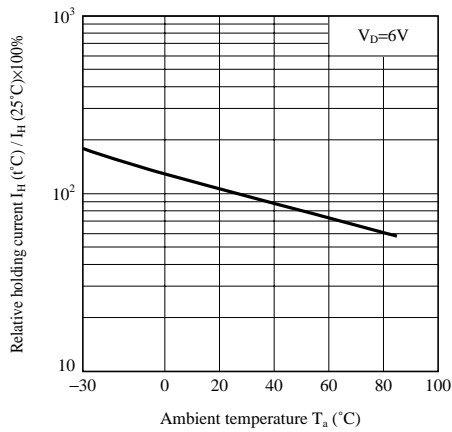

Fig.10 Relative Holding Current vs. Ambient Temperature (PR26MF11NSZ/PR36MF11NSZ)



**Fig.11 Relative Holding Current vs. Ambient Temperature (PR26MF21NSZ/PR36MF21NSZ)**



**Fig.12 Zero-cross Voltage vs. Ambient Temperature (PR26MF21NSZ/PR36MF21NSZ)**

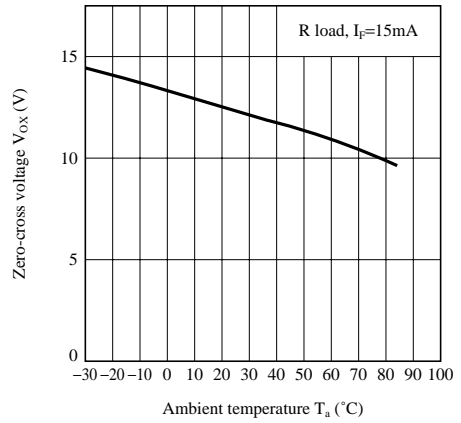

**Fig.13 ON-state Current vs. ON-state Voltage (PR26MF11NSZ/PR36MF11NSZ)**

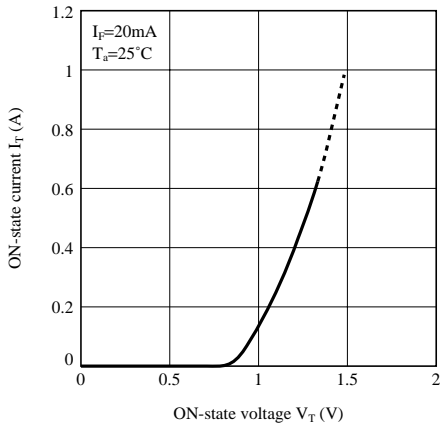

**Fig.14 ON-state Current vs. ON-state Voltage (PR26MF21NSZ/PR36MF21NSZ)**

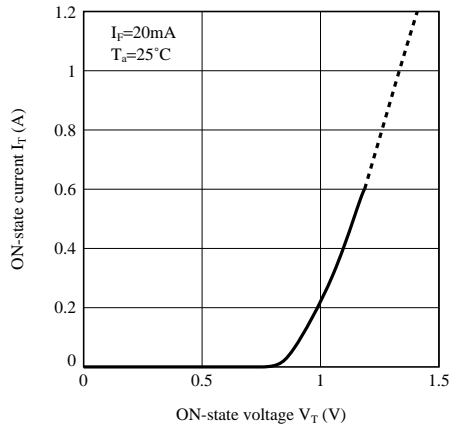

**Fig.15 Turn-on Time vs. Forward Current (PR26MF11NSZ)**

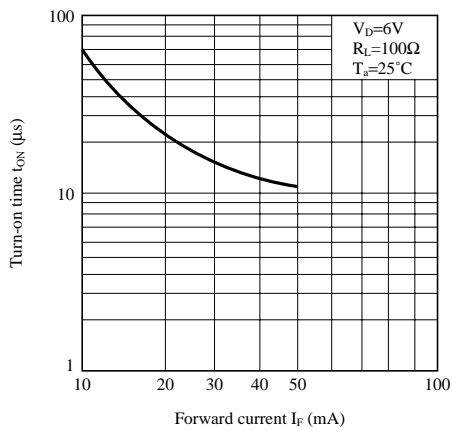

**Fig.16 Turn-on Time vs. Forward Current (PR36MF11NSZ)**

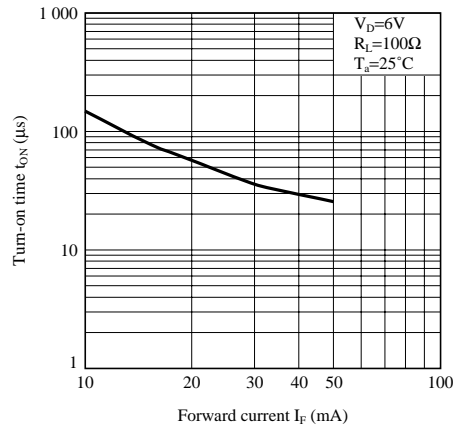
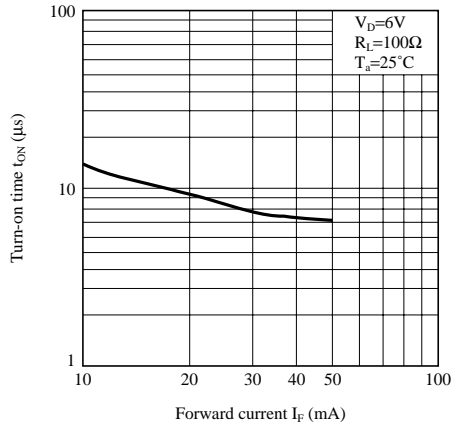

Fig.17 Turn-on Time vs. Forward Current  
(PR26MF21NSZ/PR36MF21NSZ)



## NOTICE

- The circuit application examples in this publication are provided to explain representative applications of SHARP devices and are not intended to guarantee any circuit design or license any intellectual property rights. SHARP takes no responsibility for any problems related to any intellectual property right of a third party resulting from the use of SHARP's devices.
- Contact SHARP in order to obtain the latest device specification sheets before using any SHARP device. SHARP reserves the right to make changes in the specifications, characteristics, data, materials, structure, and other contents described herein at any time without notice in order to improve design or reliability. Manufacturing locations are also subject to change without notice.
- Observe the following points when using any devices in this publication. SHARP takes no responsibility for damage caused by improper use of the devices which does not meet the conditions and absolute maximum ratings to be used specified in the relevant specification sheet nor meet the following conditions:
  - (i) The devices in this publication are designed for use in general electronic equipment designs such as:
    - Personal computers
    - Office automation equipment
    - Telecommunication equipment [terminal]
    - Test and measurement equipment
    - Industrial control
    - Audio visual equipment
    - Consumer electronics
  - (ii) Measures such as fail-safe function and redundant design should be taken to ensure reliability and safety when SHARP devices are used for or in connection with equipment that requires higher reliability such as:
    - Transportation control and safety equipment (i.e., aircraft, trains, automobiles, etc.)
    - Traffic signals
    - Gas leakage sensor breakers
    - Alarm equipment
    - Various safety devices, etc.
  - (iii) SHARP devices shall not be used for or in connection with equipment that requires an extremely high level of reliability and safety such as:
    - Space applications
    - Telecommunication equipment [trunk lines]
    - Nuclear power control equipment
    - Medical and other life support equipment (e.g., scuba).
- If the SHARP devices listed in this publication fall within the scope of strategic products described in the Foreign Exchange and Foreign Trade Law of Japan, it is necessary to obtain approval to export such SHARP devices.
- This publication is the proprietary product of SHARP and is copyrighted, with all rights reserved. Under the copyright laws, no part of this publication may be reproduced or transmitted in any form or by any means, electronic or mechanical, for any purpose, in whole or in part, without the express written permission of SHARP. Express written permission is also required before any use of this publication may be made by a third party.
- Contact and consult with a SHARP representative if there are any questions about the contents of this publication.