

# PC929

## Shortcircuit Protector Circuit Built-in Photocoupler Suitable for Inverter-Driving MOS-FET/IGBT

\* TÜV ( VDE 0884 ) approved type is also available as an option.

### ■ Features

1. Built-in IGBT shortcircuit protector circuit
2. Built-in direct drive circuit for IGBT drive  
(Peak output current ...  $I_{O1P}$ ,  $I_{O2P}$  : MAX. 0.4A)
3. High speed response ( $t_{PLH}$ ,  $t_{PHL}$  : MAX. 0.5  $\mu$  s)
4. High isolation voltage ( $V_{iso}$  : 4000V<sub>rms</sub>)
5. Half lead pin pitch (p=1.27 mm) package type
6. Recognized by UL, file NO. E64380

### ■ Application

1. IGBT control for inverter drive

### ■ Outline Dimensions

(Unit : mm)

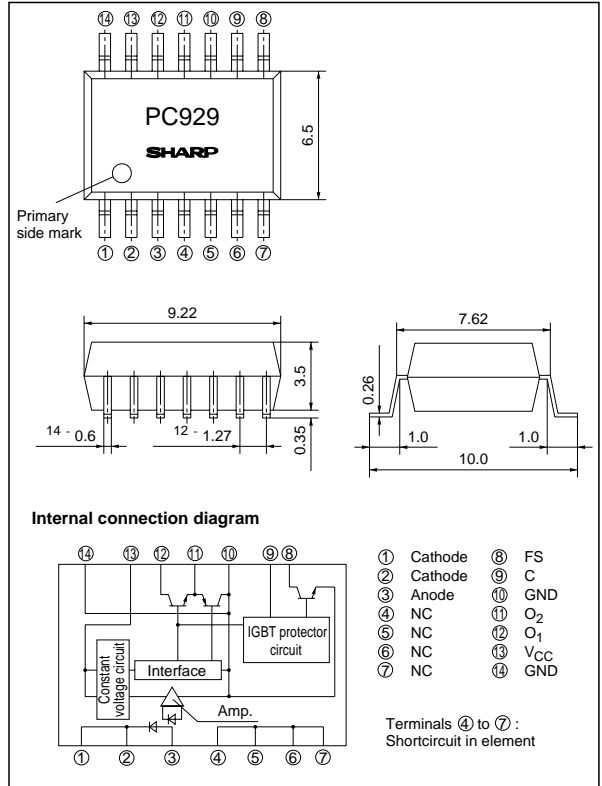

### ■ Absolute Maximum Ratings

(Ta=Topr unless otherwise specified)

	Parameter	Symbol	Rating	Unit
Input	*1 Forward current	$I_F$	20	mA
	Reverse voltage	$V_R$	6 (Ta = 25°C)	V
Output	Supply voltage	$V_{CC}$	35	V
	O <sub>1</sub> output current	$I_{O1}$	0.1	A
	*4 O <sub>1</sub> peak output current	$I_{O1P}$	0.4	A
	O <sub>2</sub> output current	$I_{O2}$	0.1	A
	*4 O <sub>2</sub> peak output current	$I_{O2P}$	0.4	A
	O <sub>1</sub> output voltage	$V_{O1}$	35	V
	*2 Power dissipation	$P_O$	500	mW
	Overcurrent detecting voltage	$V_C$	$V_{CC}$	V
	Overcurrent detecting current	$I_C$	30	mA
	Error signal output voltage	$V_{FS}$	$V_{CC}$	V
Error signal output current	$I_{FS}$	20	mA	
*3 Total power dissipation	$P_{tot}$	550	mW	
*5 Isolation voltage	$V_{iso}$	4 000	Vrms	
Operating temperature	$T_{opr}$	- 25 to + 80	°C	
Storage temperature	$T_{stg}$	- 55 to + 125	°C	
Soldering temperature	$T_{sol}$	260 (for 10 sec)	°C	

\*1, 2, 3 Decrease in the ambient temperature range of the Absolute Max. Rating : Shown in Figs 1 and 2.

\*4 Pulse width  $\leq 0.15 \mu$ s, Duty ratio=0.01

\*5 40 to 60% RH, AC for 1 minute, Ta=25°C

\* "OPIC" (Optical IC) is a trademark of the SHARP Corporation.

An OPIC consists of a light-detecting element and signal processing circuit integrated onto a single chip.

Operation truth table is shown on the next page.

## ■ Electro-optical Characteristics (1)

(Ta=Topr unless otherwise specified)

Parameter		Symbol	Conditions	MIN.	TYP.	MAX.	Unit	Measuring circuit	
Input	Forward voltage	V <sub>F1</sub>	T <sub>a</sub> = 25°C, I <sub>F</sub> = 10mA	-	1.6	1.75	V	-	
		V <sub>F2</sub>	T <sub>a</sub> = 25°C, I <sub>F</sub> = 0.2mA	1.2	1.5	-	V	-	
	Reverse current	I <sub>R</sub>	T <sub>a</sub> = 25°C, V <sub>R</sub> = 5V	-	-	10	μA	-	
	Terminal capacitance	C <sub>t</sub>	T <sub>a</sub> = 25°C, V = 0, f = 1kHz	-	30	250	pF	-	
Output	Operating supply voltage	V <sub>CC</sub>	T <sub>a</sub> = -10 to 60°C	15	-	30	V	-	
			-	15	-	24	V		
	O <sub>1</sub> low level output voltage	V <sub>O1L</sub>	V <sub>CC1</sub> = 12V, V <sub>CC2</sub> = -12V I <sub>O1</sub> = 0.1A, I <sub>F</sub> = 5mA *8	-	0.2	0.4	V	(1)	
	O <sub>2</sub> high level output voltage	V <sub>O2H</sub>	V <sub>CC</sub> = V <sub>O1</sub> = 24V, I <sub>O2</sub> = -0.1A I <sub>F</sub> = 5mA *8	20	22	-	V	(2)	
	O <sub>2</sub> low level output voltage	V <sub>O2L</sub>	V <sub>CC</sub> = V <sub>O1</sub> = 24V, I <sub>O2</sub> = 0.1A, I <sub>F</sub> = 0mA *8	-	1.2	2.0	V	(3)	
	O leak current	V <sub>O1L</sub>	T <sub>a</sub> = 25°C, V <sub>CC</sub> = V <sub>O1</sub> = 35V, I <sub>F</sub> = 0mA *8	-	-	500	μA	(4)	
	High level supply current	I <sub>CCH</sub>	T <sub>a</sub> = 25°C, V <sub>CC</sub> = V <sub>O1</sub> = 24V, I <sub>F</sub> = 5mA *8	-	10	17	mA	(6)	
V <sub>CC</sub> = V <sub>O1</sub> = 24V, I <sub>F</sub> = 5mA *8			-	-	19	mA			
Low level supply current	I <sub>CCL</sub>	T <sub>a</sub> = 25°C, V <sub>CC</sub> = V <sub>O1</sub> = 24V, I <sub>F</sub> = 0mA *8	-	11	18	mA	(6)		
		V <sub>CC</sub> = V <sub>O1</sub> = 24V, I <sub>F</sub> = 0mA *8	-	-	20	mA			
Transfer characteristics	*7 "Low→High" threshold input current	I <sub>FLH</sub>	T <sub>a</sub> = 25°C, V <sub>CC</sub> = V <sub>O1</sub> = 24V *8	0.3	1.5	3.0	mA	(5)	
			V <sub>CC</sub> = V <sub>O1</sub> = 24V *8	0.2	-	5.0	mA		
	Isolation resistance	R <sub>ISO</sub>	T <sub>a</sub> = 25°C, DC500V, 40 to 60% RH	5 × 10 <sup>10</sup>	1 × 10 <sup>11</sup>	-	Ω	-	
	Response time	"Low→High" propagation delay time	t <sub>PLH</sub>	T <sub>a</sub> = 25°C, V <sub>CC</sub> = V <sub>O1</sub> = 24V R <sub>G</sub> = 47Ω, C <sub>G</sub> = 3 000pF, I <sub>F</sub> = 5mA *8	-	0.3	0.5	μs	(8)
		"High→Low" propagation delay time	t <sub>PHL</sub>		-	0.3	0.5	μs	
		Rise time	t <sub>r</sub>		-	0.2	0.5	μs	
		Fall time	t <sub>f</sub>		-	0.2	0.5	μs	
Instantaneous common mode rejection voltage "Output : High level"	CM <sub>H</sub>	T <sub>a</sub> = 25°C, V <sub>CC</sub> = V <sub>O1</sub> = 24V, I <sub>F</sub> = 5mA V <sub>CM</sub> = 600V(peak), ΔV <sub>O2H</sub> = 2.0V *8	- 1 500	-	-	V/μs	(7)		
Instantaneous common mode rejection voltage "Output : Low level"	CM <sub>L</sub>	T <sub>a</sub> = 25°C, V <sub>CC</sub> = V <sub>O1</sub> = 24V, I <sub>F</sub> = 0mA V <sub>CM</sub> = 600V(peak), ΔV <sub>O2L</sub> = 2.0V *8	1 500	-	-	V/μs			

\*6 When measuring output and transfer characteristics, connect a bypass capacitor (0.01 μF or more) between V<sub>CC</sub> (13) and GND (14) near the device.\*7 I<sub>FLH</sub> represents forward current when output goes from "Low" to "High".\*8 FS=OPEN, V<sub>C</sub>=0V

## ■ Truth Table

Input	C Input/Output	O <sub>2</sub> Output	FS Output	
ON	Low level	High level	High level	For protective operation
	High level	Low level	Low level	
OFF	Low level	Low level	High level	
	High level	Low level	High level	

■ Electro-optical Characteristics (2)

(Ta=Topr unless otherwise specified)

	Parameter	Symbol	Conditions	MIN.	TYP.	MAX.	Unit	Test circuit
*9 Overcurrent detection	*10 Overcurrent detecting voltage	V <sub>CTH</sub>	T <sub>a</sub> = 25°C, I <sub>F</sub> = 5mA V <sub>CC</sub> = V <sub>O1</sub> = 24V, R <sub>G</sub> = 47Ω C <sub>G</sub> = 3 000pF, FS = OPEN	V <sub>CC</sub> -	V <sub>CC</sub> -	V <sub>CC</sub> -	V	(9)
	Overcurrent detecting voltage hysteresis width	V <sub>CHIS</sub>		6.5	6.0	5.5		
*9 Protective output	O <sub>2</sub> "High→Low" delay time at protection from overcurrent	t <sub>PCOHL</sub>	T <sub>a</sub> = 25°C V <sub>CC</sub> = V <sub>O1</sub> = 24V, I <sub>F</sub> = 5mA C <sub>G</sub> = 3 000pF, R <sub>G</sub> = 47Ω C <sub>P</sub> = 1 000pF, R <sub>C</sub> = 1kΩ FS = OPEN	-	4	10	μs	(13)
	O <sub>2</sub> fall time at protection from overcurrent	t <sub>PCOf</sub>		2	5	-	μs	
	O <sub>2</sub> output voltage at protection from overcurrent	V <sub>OE</sub>		-	-	2	V	(10)
*9 Error signal output	Low level error signal voltage	V <sub>FSL</sub>	T <sub>a</sub> = 25°C, I <sub>F</sub> = 5mA, I <sub>FS</sub> = 10mA V <sub>CC</sub> = V <sub>O1</sub> = 24V, R <sub>G</sub> = 47Ω, C <sub>G</sub> = 3 000pF, C = OPEN	-	0.2	0.4	V	(11)
	High level error signal current	I <sub>FSH</sub>	T <sub>a</sub> = 25°C, I <sub>F</sub> = 5mA, V <sub>FS</sub> = 24V V <sub>CC</sub> = V <sub>O1</sub> = 24V, R <sub>G</sub> = 47Ω, C <sub>G</sub> = 3 000pF, V <sub>C</sub> = 0V	-	-	100	μA	(12)
	Error signal "High→Low" delay time	t <sub>PCFHL</sub>	T <sub>a</sub> = 25°C, R <sub>FS</sub> = 1.8kΩ V <sub>CC</sub> = V <sub>O1</sub> = 24V, I <sub>F</sub> = 5mA C <sub>G</sub> = 3 000pF, R <sub>G</sub> = 47Ω C <sub>P</sub> = 1 000pF, R <sub>C</sub> = 1kΩ	-	1	5	μs	(14)
	Error signal output pulse width	Δ t <sub>FS</sub>		20	35	-	μs	

\*9 When measuring overcurrent, protective output and error signal output characteristics, connect a bypass capacitor (0.01 μF or more) between V<sub>CC</sub> (13) and GND (14) near the device.

\*10 V<sub>CTH</sub> represents C-terminal voltage when O<sub>2</sub> output goes from "High" to "Low".

Fig. 1 Forward Current vs. Ambient Temperature

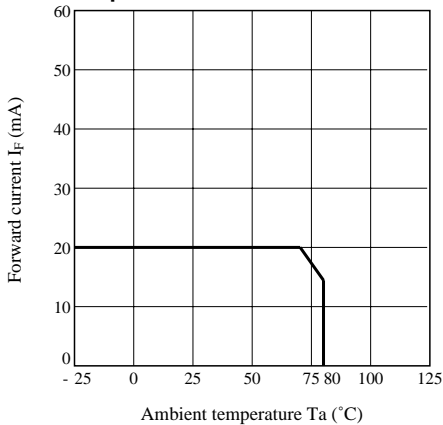
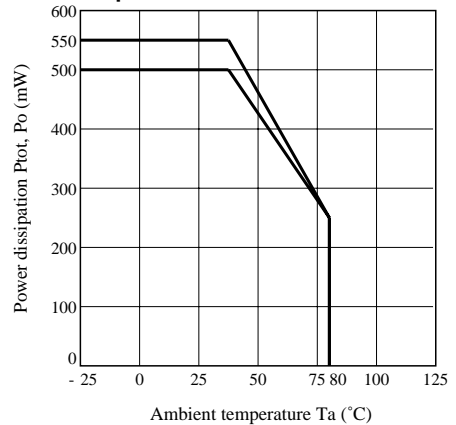
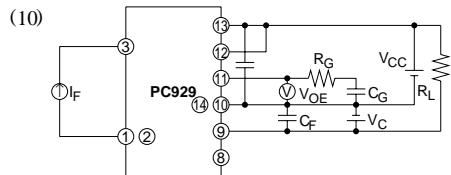
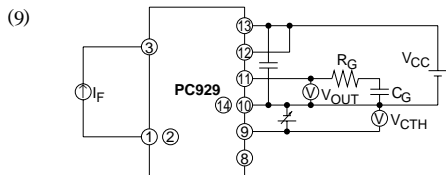
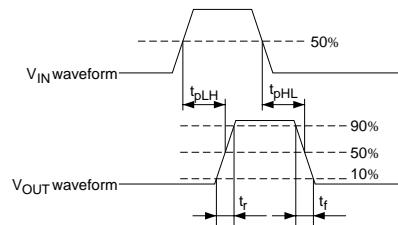
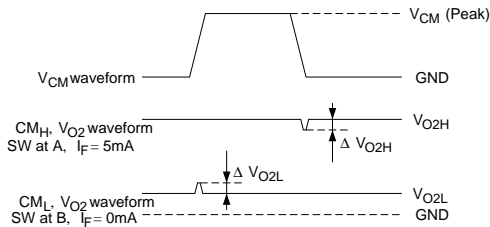
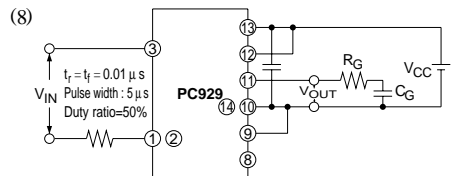
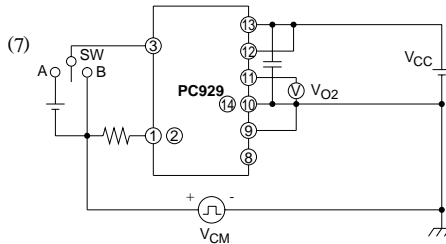
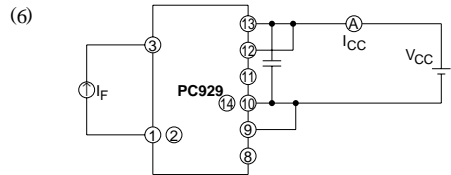
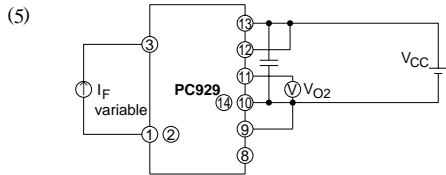
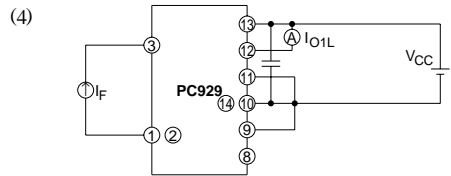
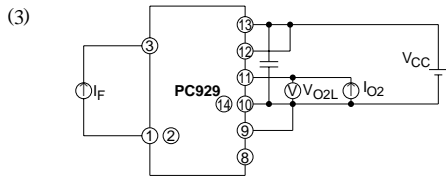
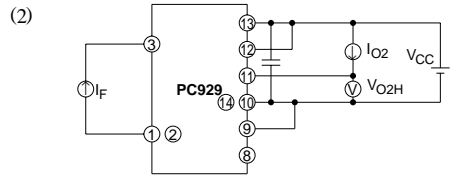
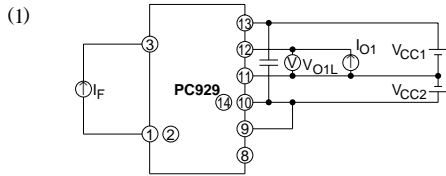

Fig. 2 Power Dissipation vs. Ambient Temperature



**Test Circuit Diagram**



■ Test Circuit Diagram

(11)

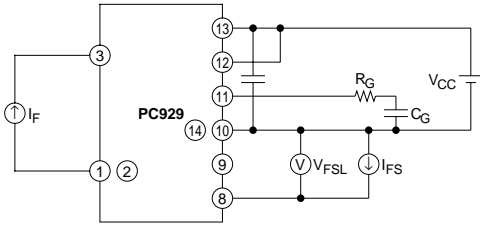

(12)

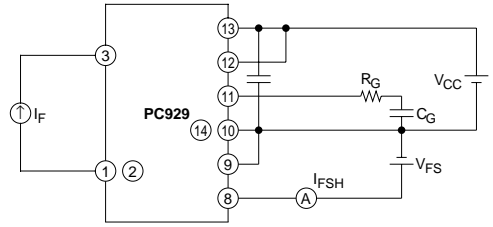

(13)

V<sub>OUT</sub>

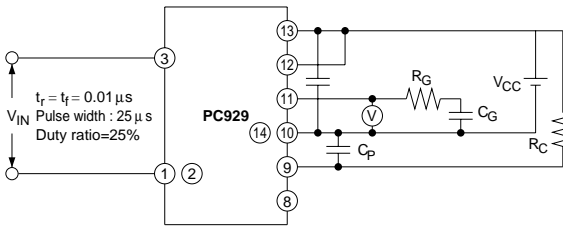

(14)

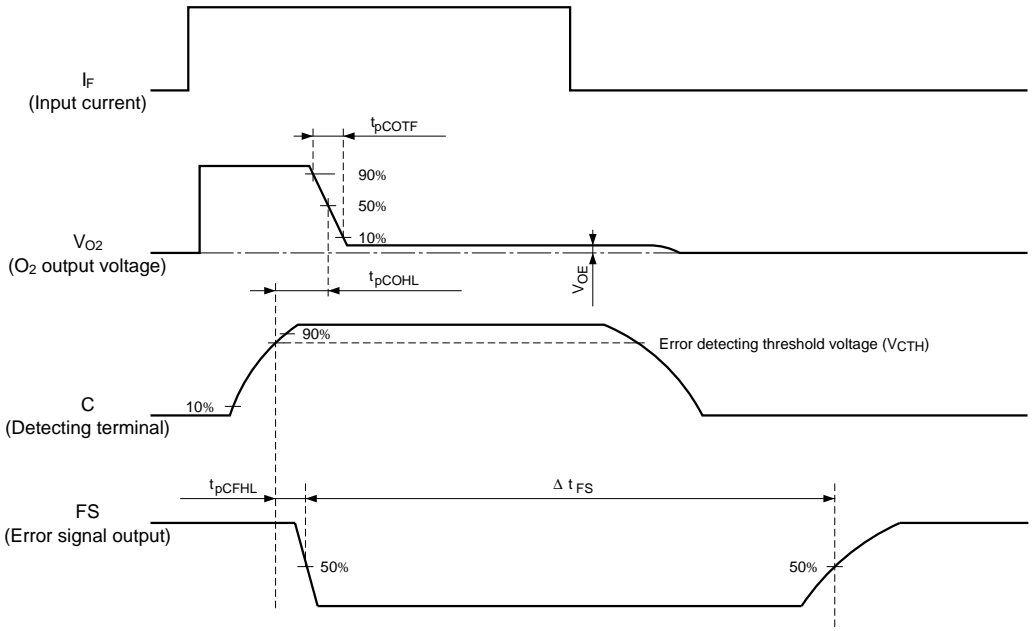
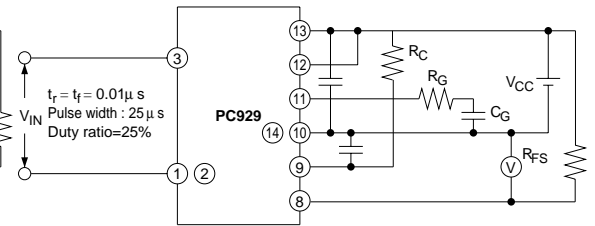

## Operations of Shortcircuit Protector Circuit

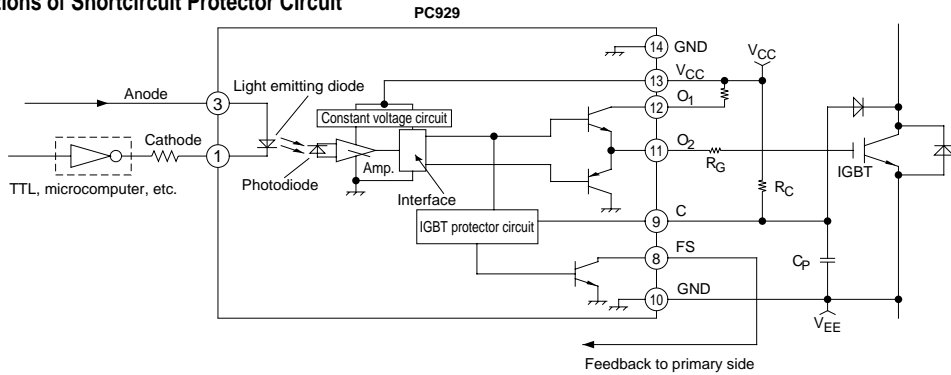

1. Detection of increase in  $V_{CE}$  (sat) of IGBT due to overcurrent by means of C-terminal (9) terminal
2. Reduction of the IGBT gate voltage, and suppression of the collector current.
3. Simultaneous output of signals to indicate the shortcircuit condition (FS signal) from FS terminal to the microcomputer
4. Judgement and processing by the microcomputer
  - In the case of instantaneous shortcircuit, run continues.
  - At fault, input to the photocoupler is cut off, and IGBT is turned OFF.

## Precautions for Operation

1. It is recommended that a capacitor of about 1000pF is added between C-terminal and GND in order to prevent malfunction of C-terminal due to noise. In the case of capacitor added, rise of the detecting voltage is delayed. Thus, use together a resistance of about 1kΩ set between  $V_{CC}$  and C-terminal.  
The C-terminal rise time varies with the time constant of CR added. Check sufficiently before use.
2. The light-detecting element used for this product is provided with a parasitic diode between each terminal and GND. When a terminal happens to reach electric potential lower than GND potential even in a moment, malfunction or rupture may result. Design the circuit so that each terminal will be kept at electric potential lower than the GND potential at all times.

### NOTICE

- The circuit application examples in this publication are provided to explain representative applications of SHARP devices and are not intended to guarantee any circuit design or license any intellectual property rights. SHARP takes no responsibility for any problems related to any intellectual property right of a third party resulting from the use of SHARP's devices.
- Contact SHARP in order to obtain the latest device specification sheets before using any SHARP device. SHARP reserves the right to make changes in the specifications, characteristics, data, materials, structure, and other contents described herein at any time without notice in order to improve design or reliability. Manufacturing locations are also subject to change without notice.
- Observe the following points when using any devices in this publication. SHARP takes no responsibility for damage caused by improper use of the devices which does not meet the conditions and absolute maximum ratings to be used specified in the relevant specification sheet nor meet the following conditions:
  - (i) The devices in this publication are designed for use in general electronic equipment designs such as:
    - Personal computers
    - Office automation equipment
    - Telecommunication equipment [terminal]
    - Test and measurement equipment
    - Industrial control
    - Audio visual equipment
    - Consumer electronics
  - (ii) Measures such as fail-safe function and redundant design should be taken to ensure reliability and safety when SHARP devices are used for or in connection with equipment that requires higher reliability such as:
    - Transportation control and safety equipment (i.e., aircraft, trains, automobiles, etc.)
    - Traffic signals
    - Gas leakage sensor breakers
    - Alarm equipment
    - Various safety devices, etc.
  - (iii) SHARP devices shall not be used for or in connection with equipment that requires an extremely high level of reliability and safety such as:
    - Space applications
    - Telecommunication equipment [trunk lines]
    - Nuclear power control equipment
    - Medical and other life support equipment (e.g., scuba).
- Contact a SHARP representative in advance when intending to use SHARP devices for any "specific" applications other than those recommended by SHARP or when it is unclear which category mentioned above controls the intended use.
- If the SHARP devices listed in this publication fall within the scope of strategic products described in the Foreign Exchange and Foreign Trade Control Law of Japan, it is necessary to obtain approval to export such SHARP devices.
- This publication is the proprietary product of SHARP and is copyrighted, with all rights reserved. Under the copyright laws, no part of this publication may be reproduced or transmitted in any form or by any means, electronic or mechanical, for any purpose, in whole or in part, without the express written permission of SHARP. Express written permission is also required before any use of this publication may be made by a third party.
- Contact and consult with a SHARP representative if there are any questions about the contents of this publication.