

PC457L0NIP

High Speed and High CMR *OPIC Photocoupler

■ Features

1. High resistance to noise (CMR:MIN. 15kV/μs)
2. High speed response
(t_{PHL} :MAX. 0.8μs, t_{PLH} :MAX. 0.8μs)
3. Mini-flat package
4. Isolation voltage ($V_{iso(rms)}$):3.75kV)
5. Recognized by UL, file No. E64380 (Model No. **PC457L**)

■ Applications

1. Programmable controller
2. Inverter

■ Absolute Maximum Ratings

(T_a=25°C)

Parameter	Symbol	Rating	Unit	
Input	*1 Forward current	I _F	25	mA
	Reverse voltage	V _R	5	V
Output	*2 Power dissipation	P	45	mW
	Supply voltage	V _{CC}	-0.5 to +30	V
	Output voltage	V _O	-0.5 to +20	V
	Output current	I _O	8	mA
	*3 Power dissipation	P _O	100	mW
	*3 Total power dissipation	P _{tot}	100	mW
	*4 Isolation voltage	V _{iso(rms)}	3.75	kV
	Operating temperature	T _{opr}	-55 to +100	°C
	Storage temperature	T _{stg}	-55 to +125	°C
	*5 Soldering temperature	T _{sol}	270	°C

*1 When ambient temperature goes above 70°C, the power dissipation goes down at 0.8mA/°C

*2 When ambient temperature goes above 70°C, the power dissipation goes down at 0.8mW/°C

*3 When ambient temperature goes above 70°C, the power dissipation goes down at 1.8mW/°C

*4 40 to 60%RH, AC for 1minute

*5 For 10s

■ Outline Dimensions

(Unit : mm)

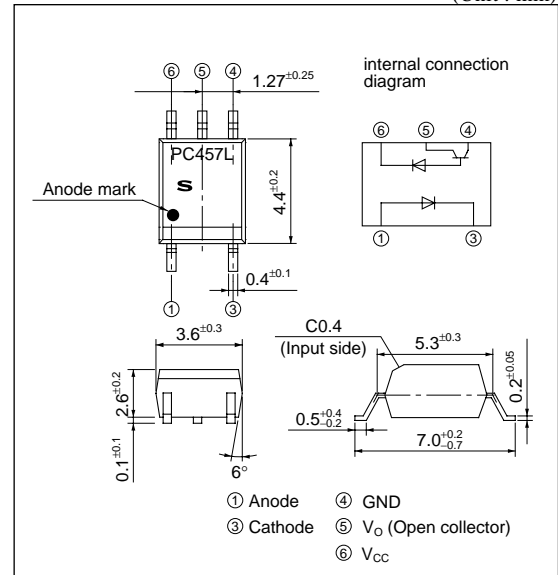

* "OPIC" (Optical IC) is a trademark of the SHARP Corporation.
An OPIC consists of a light-detecting element and signal-processing circuit integrated onto a single chip.

■ Electro-optical Characteristics

(T_a=25°C)

Parameter		Symbol	Conditions	MIN.	TYP.	MAX.	Unit
Input	Forward voltage	V _F	I _F =16mA	—	1.7	1.95	V
	Reverse current	I _R	V _R =5V	—	—	10	μA
	Terminal capacitance	C _t	V _F =0V, f=1MHz	—	60	250	pF
Output	High level output current (1)	I _{OH(1)}	I _F =0, V _{CC} =5.5V, V _O =5.5V	—	3	500	nA
	High level output current (2)	I _{OH(2)}	I _F =0, V _{CC} =15V, V _O =15V	—	—	1.0	μA
	*6 High level output current (3)	I _{OH(3)}	I _F =0, V _{CC} =15V, V _O =15V	—	—	50	μA
	High level supply current (1)	I _{CCH(1)}	I _F =0, V _{CC} =15V, V _O =open	—	0.02	1.0	μA
	*6 High level supply current (2)	I _{CCH(2)}	I _F =0, V _{CC} =15V, V _O =open	—	—	2.0	μA
	Low level supply current	I _{CCL}	I _F =16mA, V _{CC} =15V, V _O =open	—	120	—	μA
	Low level output voltage	V _{OL}	I _F =16mA, V _{CC} =4.5V, I _O =2.4mA	—	—	0.4	V
Transfer characteristics	Current transfer ratio (1)	CTR (1)	I _F =16mA, V _{CC} =4.5V, V _O =0.4V	19	—	50	%
	*6 Current transfer ratio (2)	CTR (2)	I _F =16mA, V _{CC} =4.5V, V _O =0.4V	15	—	—	%
	*7 "High→Low" propagation delay time	t _{PHL}	I _F =16mA, V _{CC} =5V R _L =1.9kΩ	—	0.2	0.8	μs
	*7 "Low→High" propagation delay time	t _{PLH}		—	0.6	0.8	μs
	*8 Instantaneous common mode rejection voltage "Output : High level"	CM _H	I _F =0, R _L =1.9kΩ V _{CC} =5V, V _{CM} =1.0kV _(p-p)	15	30	—	kV/μs
	*8 Instantaneous common mode rejection voltage "Output : Low level"	CM _L	I _F =16mA, R _L =1.9kΩ V _{CC} =5V, V _{CM} =1.0kV _(p-p)	-15	-30	—	kV/μs
	Isolation resistance	R _{ISO}	DC=500V, 40 to 60% RH	5×10 ¹⁰	1×10 ¹¹	—	Ω
Floating capacitance	C _f	V=0, f=1MHz	—	0.6	1.0	pF	

*6 T_a=0 to 70°C

*7 Refer to Fig.1

*8 Refer to Fig.2

Fig.1 Test Circuit for Propagation Delay Time

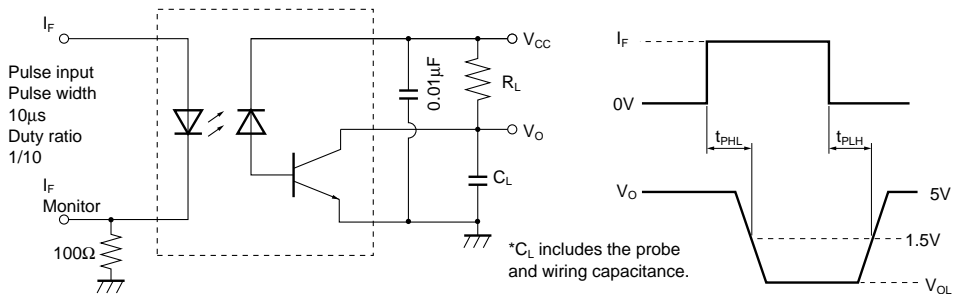

Fig.2 Test Circuit for Instantaneous Common Mode Rejection Voltage

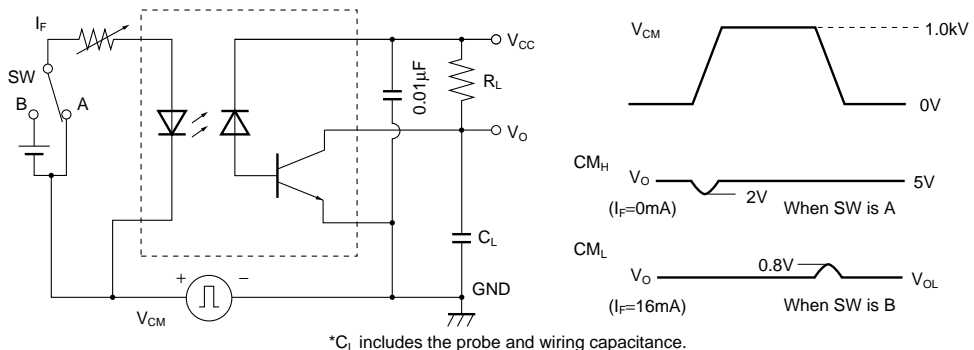

Fig.3 Forward Current vs. Ambient Temperature

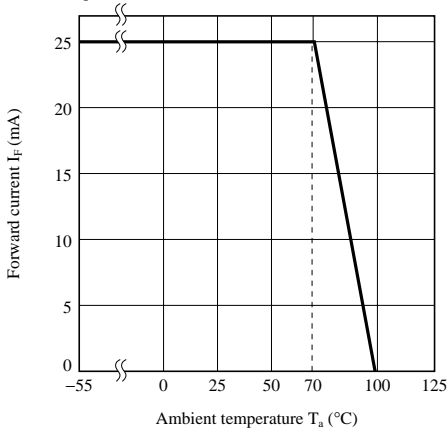

Fig.4 Power Dissipation vs. Ambient Temperature

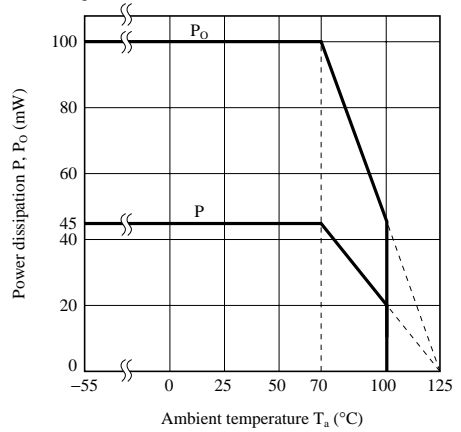

Fig.5 Forward Current vs. Forward Voltage

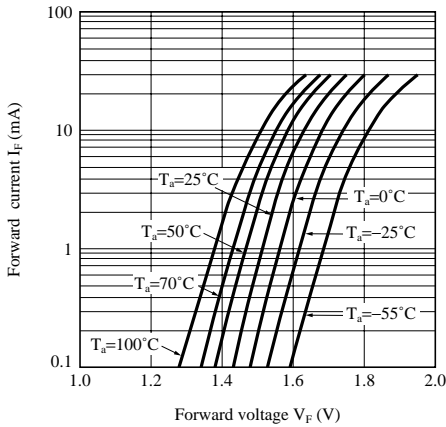

Fig.6 Relative Current Transfer Ratio vs. Forward Current

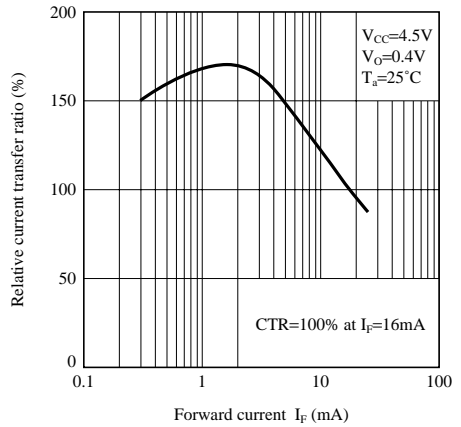

Fig.7 Output Current vs. Output Voltage

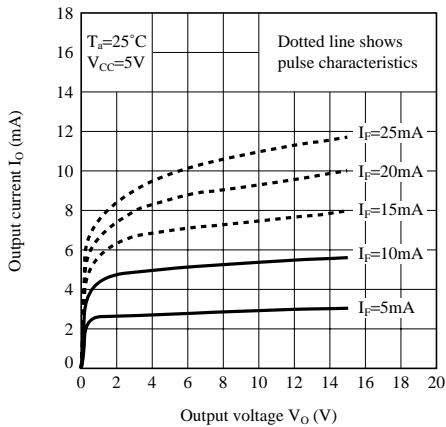

Fig.8 Relative Current Transfer Ratio vs. Ambient Temperature

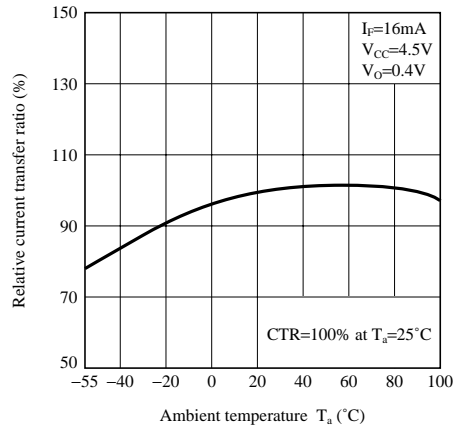

Fig.9 High Level Output Current vs. Ambient Temperature

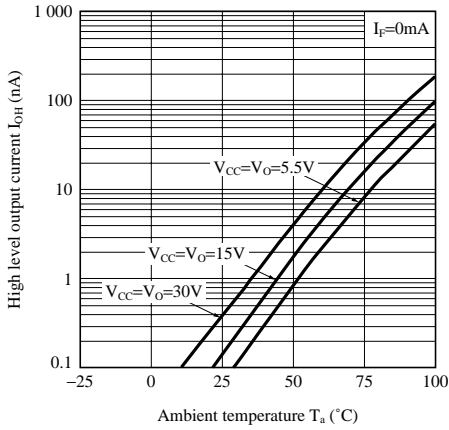
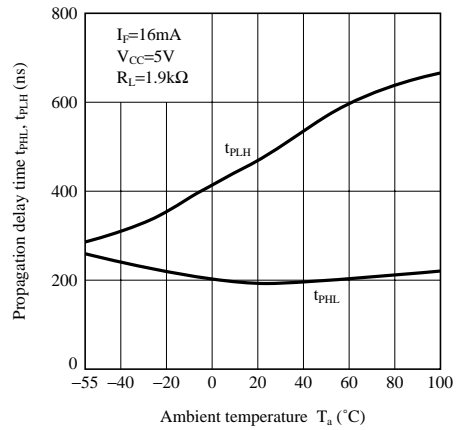

Fig.10 Propagation Delay Time vs. Ambient Temperature



NOTICE

- The circuit application examples in this publication are provided to explain representative applications of SHARP devices and are not intended to guarantee any circuit design or license any intellectual property rights. SHARP takes no responsibility for any problems related to any intellectual property right of a third party resulting from the use of SHARP's devices.
- Contact SHARP in order to obtain the latest device specification sheets before using any SHARP device. SHARP reserves the right to make changes in the specifications, characteristics, data, materials, structure, and other contents described herein at any time without notice in order to improve design or reliability. Manufacturing locations are also subject to change without notice.
- Observe the following points when using any devices in this publication. SHARP takes no responsibility for damage caused by improper use of the devices which does not meet the conditions and absolute maximum ratings to be used specified in the relevant specification sheet nor meet the following conditions:
 - (i) The devices in this publication are designed for use in general electronic equipment designs such as:
 - Personal computers
 - Office automation equipment
 - Telecommunication equipment [terminal]
 - Test and measurement equipment
 - Industrial control
 - Audio visual equipment
 - Consumer electronics
 - (ii) Measures such as fail-safe function and redundant design should be taken to ensure reliability and safety when SHARP devices are used for or in connection with equipment that requires higher reliability such as:
 - Transportation control and safety equipment (i.e., aircraft, trains, automobiles, etc.)
 - Traffic signals
 - Gas leakage sensor breakers
 - Alarm equipment
 - Various safety devices, etc.
 - (iii) SHARP devices shall not be used for or in connection with equipment that requires an extremely high level of reliability and safety such as:
 - Space applications
 - Telecommunication equipment [trunk lines]
 - Nuclear power control equipment
 - Medical and other life support equipment (e.g., scuba).
- If the SHARP devices listed in this publication fall within the scope of strategic products described in the Foreign Exchange and Foreign Trade Law of Japan, it is necessary to obtain approval to export such SHARP devices.
- This publication is the proprietary product of SHARP and is copyrighted, with all rights reserved. Under the copyright laws, no part of this publication may be reproduced or transmitted in any form or by any means, electronic or mechanical, for any purpose, in whole or in part, without the express written permission of SHARP. Express written permission is also required before any use of this publication may be made by a third party.
- Contact and consult with a SHARP representative if there are any questions about the contents of this publication.