

PC3H4/PC3Q64Q

Mini-falt Package AC Input Type Half Pitch Photocoupler

■ Features

1. AC input type
2. Half pitch type (lead pitch : 1.27mm)
3. Isolation voltage between input and output
(Viso: 2 500Vrms)
4. Applicable to infrared ray reflow
(230°C, for MAX. 30s)
5. High reliability
6. Taping package
PC3H4 (1ch), **PC3Q64Q** (4ch)
7. Recognized by UL, file No. E64380
Approved by VDE, No.5922UG

■ Applications

1. Programmable controllers

■ Package Specifications

Model No.	Taping specifications
PC3H4	Taping reel diameter 330mm (3 000pcs.)
PC3Q64Q	Taping reel diameter 330mm (1 000pcs.)

■ Absolute Maximum Ratings (Ta=25°C)

	Parameter	Symbol	Rating	Unit
Input	Forward current	I _F	±50	mA
	*1Peak forward current	I _{FM}	±1	A
	Power dissipation	P	70	mW
Output	Collector-emitter voltage	V _{CEO}	70	V
	Collector-emitter voltage	V _{CEO}	35	V
	Emitter-collector voltage	V _{ECO}	6	V
	Collector current	I _C	50	mA
	Collector power dissipation	P _C	150	mW
	Total power dissipation	P _{tot}	170	mW
	*2Isolation voltage	V _{iso}	2.5	kV _{rms}
	Operating temperature	T _{opr}	-30 to +100	°C
	Storage temperature	T _{stg}	-40 to +125	°C
	*3Soldering temperature	T _{sol}	260	°C

*1 Pulse width<=100μs, Duty ratio : 0.001

*2 AC for 1min, 40 to 60%RH, f=60Hz

*3 For 10s

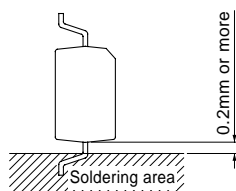

■ Outline Dimensions

(Unit : mm)

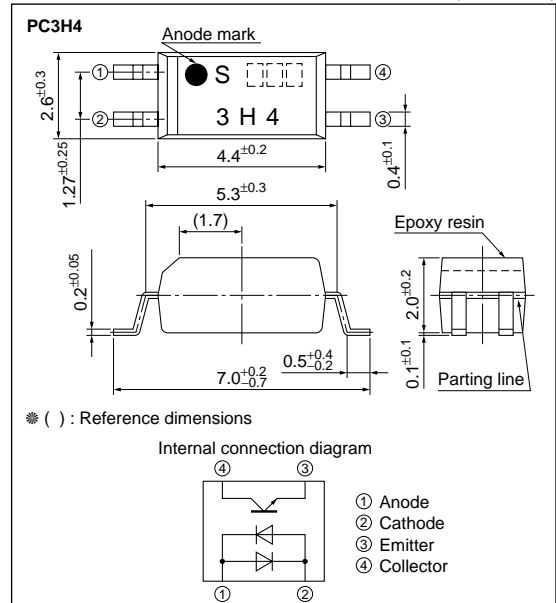

PC3Q64Q

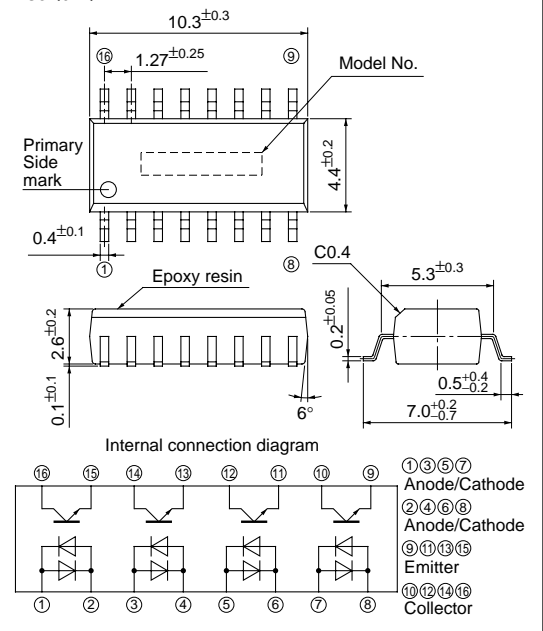

Electro-optical Characteristics

($T_a=25^\circ\text{C}$)

Parameter		Symbol	Conditions	MIN.	TYP.	MAX.	Unit
Input	Forward voltage	V_F	$I_F=\pm 20\text{mA}$	-	1.2	1.4	V
	Terminal capacitance	C_t	$V=0, f=1\text{kHz}$	-	30	250	pF
Output	Collector dark current	PC3H4	$V_{CE}=50\text{V}, I_F=0$	-	-	100	nA
		PC3Q64Q	$V_{CE}=20\text{V}, I_F=0$	-	-	100	nA
	Collector-emitter breakdown voltage	PC3H4	$I_C=0.1\text{mA}, I_F=0$	70	-	-	V
		PC3Q64Q	$I_C=0.1\text{mA}, I_F=0$	35	-	-	V
Emitter-collector breakdown voltage	BV_{ECO}	$I_E=10\mu\text{A}, I_F=0$	6	-	-	V	
Transfer characteristics	Collector current	I_C	$I_F=\pm 1\text{mA}$ $V_{CE}=5\text{V}$	0.2	-	4.0	mA
	Collector-emitter saturation voltage	$V_{CE(sat)}$	$I_F=\pm 20\text{mA}$ $I_C=1\text{mA}$	-	0.1	0.2	V
	Isolation resistance	R_{ISO}	DC500V 40 to 60%RH	5×10^{10}	1×10^{11}	-	Ω
	Floating capacitance	C_f	$V=0, f=1\text{MHz}$	-	0.6	1.0	pF
	Response time	Rise time	t_r	$V_{CE}=2\text{V}$ $I_C=2\text{mA}$ $R_L=100\Omega$	-	4	18
Fall time		t_f		-	3	18	μs

Fig.1 Forward Current vs. Ambient Temperature

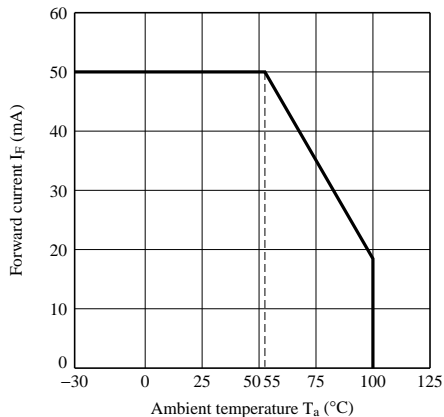

Fig.2 Diode Power Dissipation vs. Ambient Temperature

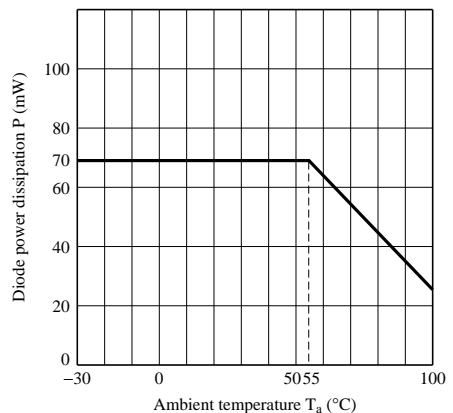

Fig.3 Collector Power Dissipation vs. Ambient Temperature

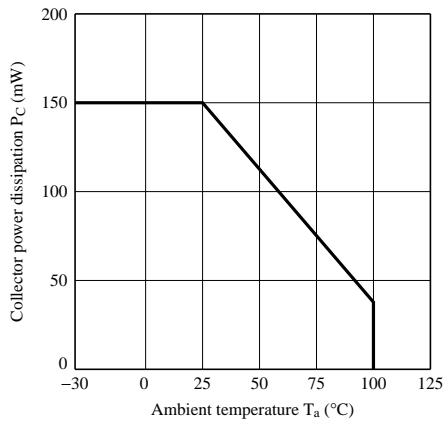

Fig.4 Total Power Dissipation vs. Ambient Temperature

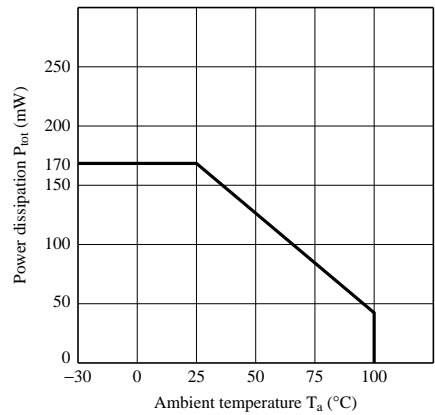

Fig.5 Peak Forward Current vs. Duty Ratio

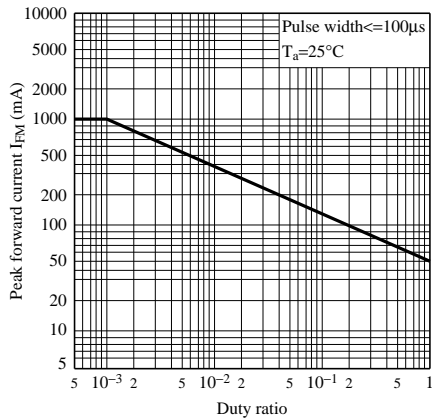

Fig.6 Forward Current vs. Forward Voltage

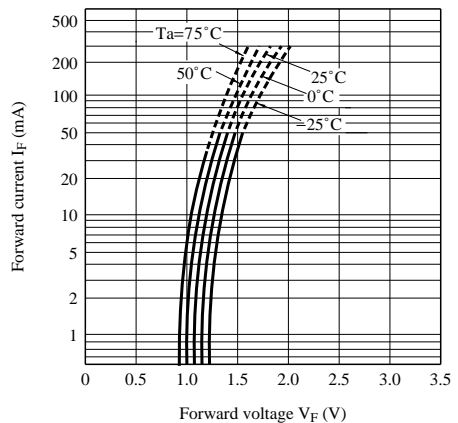

Fig.7 Current Transfer Ratio vs. Forward Current

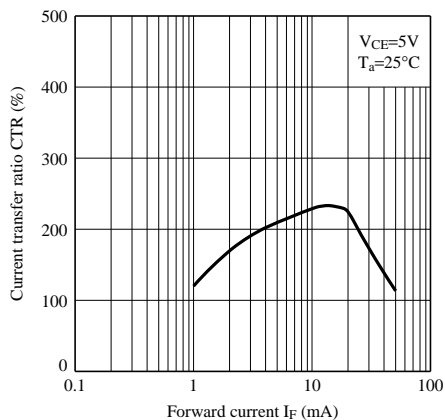

Fig.8 Collector Current vs. Collector-emitter Voltage

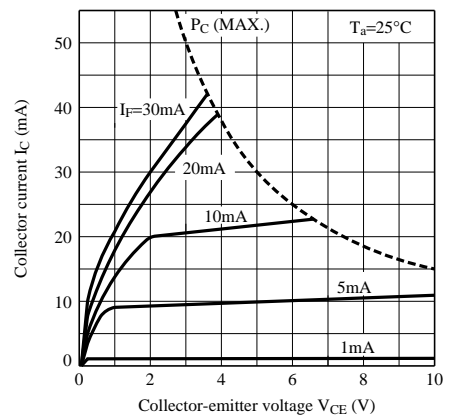

Fig.9 Relative Current Transfer Ratio vs. Ambient Temperature

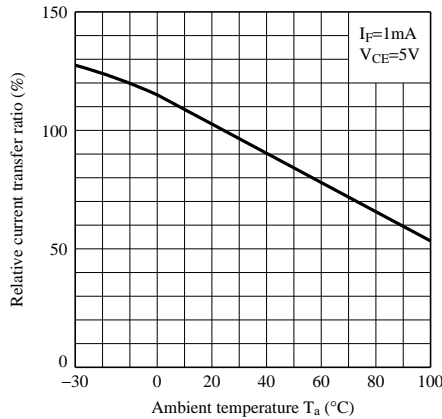

Fig.10 Collector-emitter Saturation Voltage vs. Ambient Temperature

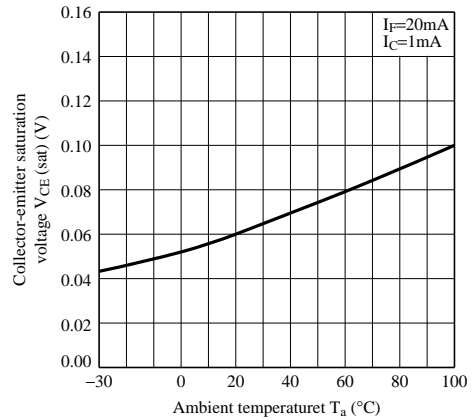

Fig.11 Collector Dark Current vs. Ambient Temperature

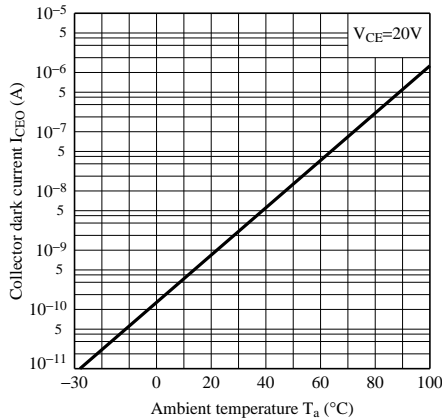

Fig.12 Response Time vs. Load Resistance

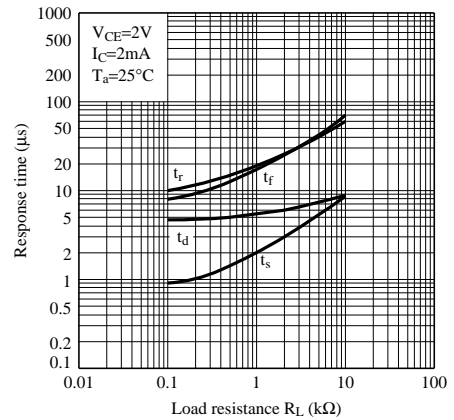

Fig.13 Test Circuit For Response Time

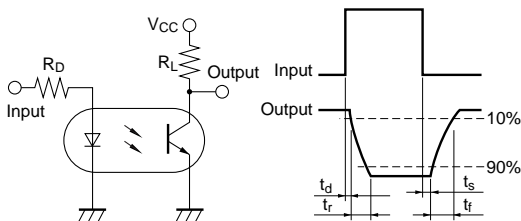

Fig.14 Collector-emitter Saturation Voltage vs. Forward Current

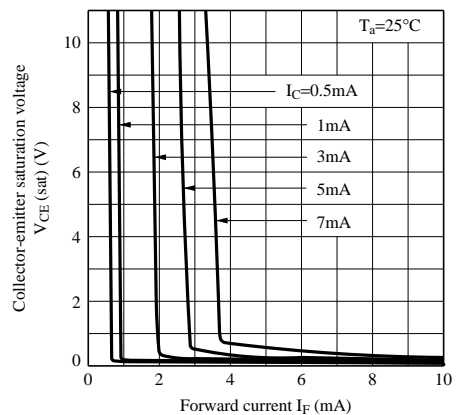
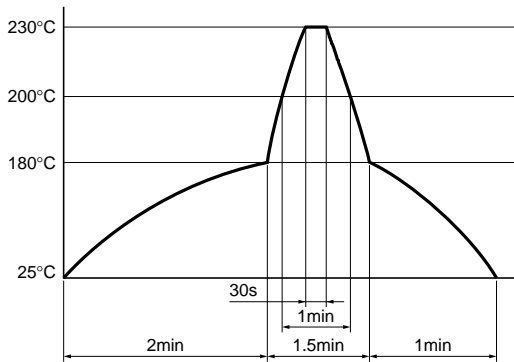

Fig.5 Reflow Soldering

Only one time soldering is recommended within the temperature profile shown below.



■ Precautions for Use

Please refer to the chapter "Precautions for Use".

NOTICE

- The circuit application examples in this publication are provided to explain representative applications of SHARP devices and are not intended to guarantee any circuit design or license any intellectual property rights. SHARP takes no responsibility for any problems related to any intellectual property right of a third party resulting from the use of SHARP's devices.
- Contact SHARP in order to obtain the latest device specification sheets before using any SHARP device. SHARP reserves the right to make changes in the specifications, characteristics, data, materials, structure, and other contents described herein at any time without notice in order to improve design or reliability. Manufacturing locations are also subject to change without notice.
- Observe the following points when using any devices in this publication. SHARP takes no responsibility for damage caused by improper use of the devices which does not meet the conditions and absolute maximum ratings to be used specified in the relevant specification sheet nor meet the following conditions:
 - (i) The devices in this publication are designed for use in general electronic equipment designs such as:
 - Personal computers
 - Office automation equipment
 - Telecommunication equipment [terminal]
 - Test and measurement equipment
 - Industrial control
 - Audio visual equipment
 - Consumer electronics
 - (ii) Measures such as fail-safe function and redundant design should be taken to ensure reliability and safety when SHARP devices are used for or in connection with equipment that requires higher reliability such as:
 - Transportation control and safety equipment (i.e., aircraft, trains, automobiles, etc.)
 - Traffic signals
 - Gas leakage sensor breakers
 - Alarm equipment
 - Various safety devices, etc.
 - (iii) SHARP devices shall not be used for or in connection with equipment that requires an extremely high level of reliability and safety such as:
 - Space applications
 - Telecommunication equipment [trunk lines]
 - Nuclear power control equipment
 - Medical and other life support equipment (e.g., scuba).
- Contact a SHARP representative in advance when intending to use SHARP devices for any "specific" applications other than those recommended by SHARP or when it is unclear which category mentioned above controls the intended use.
- If the SHARP devices listed in this publication fall within the scope of strategic products described in the Foreign Exchange and Foreign Trade Control Law of Japan, it is necessary to obtain approval to export such SHARP devices.
- This publication is the proprietary product of SHARP and is copyrighted, with all rights reserved. Under the copyright laws, no part of this publication may be reproduced or transmitted in any form or by any means, electronic or mechanical, for any purpose, in whole or in part, without the express written permission of SHARP. Express written permission is also required before any use of this publication may be made by a third party.
- Contact and consult with a SHARP representative if there are any questions about the contents of this publication.