

# PC3H3/PC3Q63

## High Resistance to Noise, AC Input Type Half Pitch Photocoupler

### ■ Features

1. Half pitch surface mount type for high density mounting  
(Lead pitch : 1.27 mm)
2. AC input type
3. High resistance to noise due to high common mode rejection voltage (CMR : MIN.10kV/μs)
4. Soldering reflow type (230°C, for 30s)
5. High temperature tested model
6. Taping package  
**PC3H3** (1ch)  
**PC3Q63** (4ch)
7. Recognized by UL, file No. E64380

### ■ Applications

1. Programmable controllers

### ■ Package Specifications

Model No.	Package specification
<b>PC3H3</b>	Taping reel diameter 330mm (3 000pcs)
<b>PC3Q63</b>	Taping reel diameter 330mm (1 000pcs)

### ■ Absolute Maximum Ratings

(Ta=25°C)

Parameter	Symbol	Rating	Unit
Input	*1 Forward current	IF	±50 mA
	*2 Peak forward current	IFM	±1 A
	*1 Power dissipation	P	70 mW
Output	Collector-emitter voltage	VCEO	70 V
	Emitter-collector voltage	VECO	6 V
	Collector current	IC	50 mA
	*1 Collector power dissipation	PC	150 mW
	*1 Total power dissipation	Ptot	170 mW
	Operating temperature	Topr	-30 to +100 °C
	Storage temperature	Tstg	-40 to +125 °C
*3 Isolation voltage	Viso	2.5 kVrms	
*4 Soldering temperature	Tsol	260 °C	

\*1 The derating factors of absolute maximum ratings due to ambient temperature are shown in Fig.2 to 5

\*2 Pulse width<=100μs, Duty ratio:0.01, Refer to Fig.6

\*3 AC for 1min., 40 to 60% RH, f=60Hz

\*4 For 10s

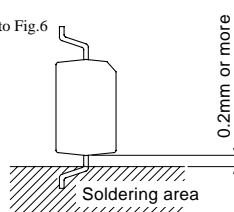

### ■ Outline Dimensions

(Unit : mm)

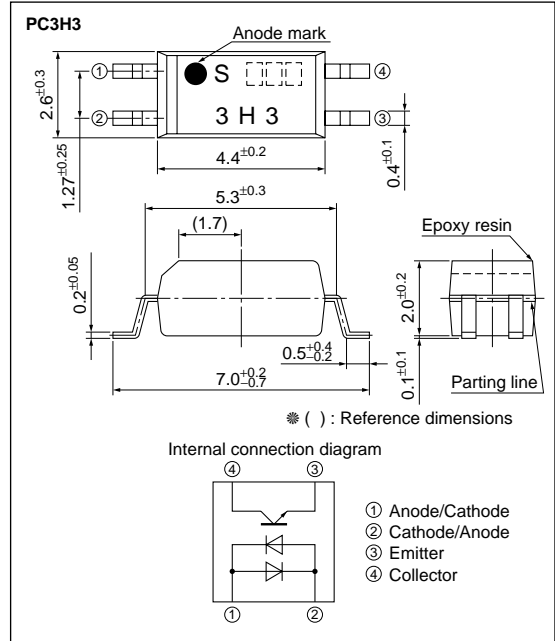

### PC3Q63

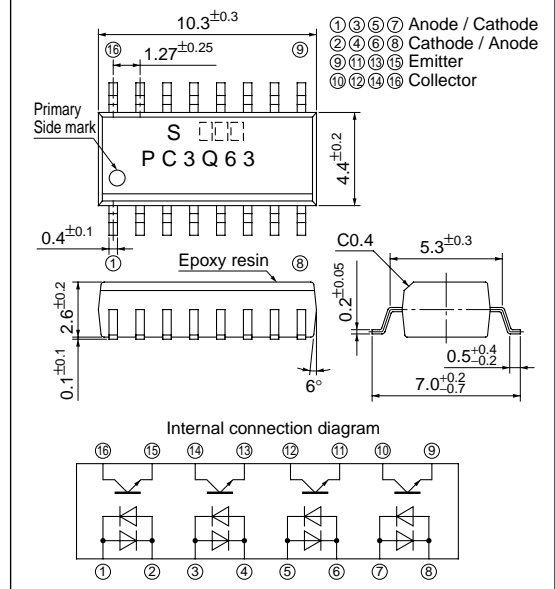

■ Electro-optical Characteristics

(Ta=25°C)

Parameter		Symbol	Conditions	MIN.	TYP.	MAX.	Unit	
Input	Forward voltage	$V_F$	$I_F=\pm 20\text{mA}$	-	1.2	1.4	V	
	Terminal capacitance	$C_t$	$V=0, f=1\text{kHz}$	-	30	250	pF	
Output	Collector dark current	PC3H3 PC3Q63	$I_{CEO}$	$V_{CE}=50\text{V}, I_F=0$	-	-	100	nA
				$V_{CE}=20\text{V}, I_F=0$	-	-	-	-
	Collector-emitter breakdown voltage	$BV_{CEO}$	$I_C=0.1\text{mA}$ $I_F=0$	70	-	-	V	
	Emitter-collector breakdown voltage	$BV_{ECO}$	$I_E=10\mu\text{A}, I_F=0$	6	-	-	V	
Transfer characteristics	Collector current	$I_C$	$I_F=\pm 1\text{mA}$ $V_{CE}=5\text{V}$	0.2	-	4.0	mA	
	Collector-emitter saturation voltage	$V_{CE(sat)}$	$I_F=\pm 20\text{mA}$ $I_C=1\text{mA}$	-	0.1	0.2	V	
	Isolation resistance	$R_{ISO}$	DC500V 40 to 60%RH	$5 \times 10^{10}$	$1 \times 10^{11}$	-	$\Omega$	
	Floating capacitance	$C_f$	$V=0, f=1\text{MHz}$	-	0.6	1.0	pF	
	Response time	Rise time	$t_r$	$V_{CE}=2\text{V}$ $I_C=2\text{mA}$ $R_L=100\Omega$	-	4	18	$\mu\text{s}$
		Fall time	$t_f$		-	3	18	$\mu\text{s}$
*5 Common mode rejection voltage		CMR	Ta=25°C, $R_L=470\Omega$ $V_{CM}=1.5\text{kV(peak)}$ $I_F=0\text{mA}, V_{CC}=9\text{V},$ $V_{np}=100\text{mV}$	10	-	-	$\text{kV}/\mu\text{s}$	

\*5 Refer to Fig.1

Fig.1 Test Circuit for Common Mode Rejection Voltage

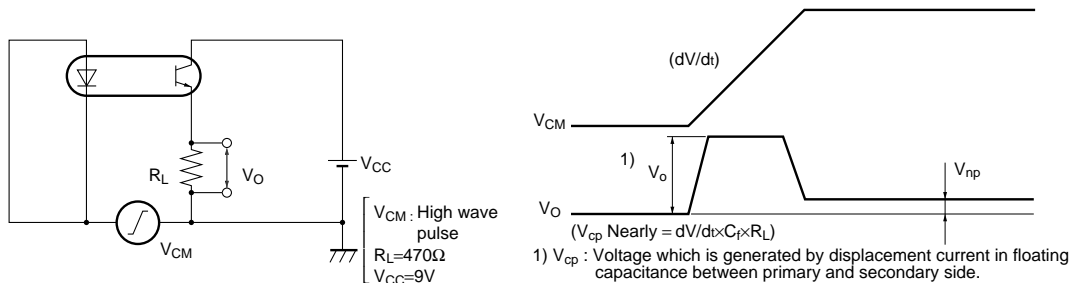

**Fig.2 Forward Current vs. Ambient Temperature**

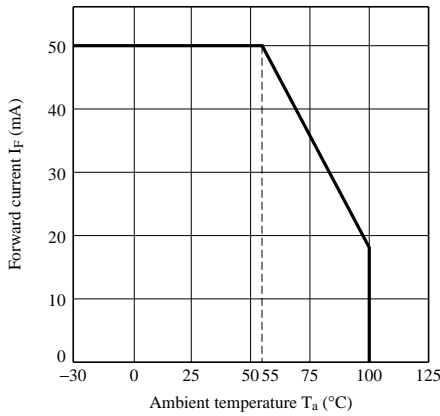

**Fig.3 Diode Power Dissipation vs. Ambient Temperature**

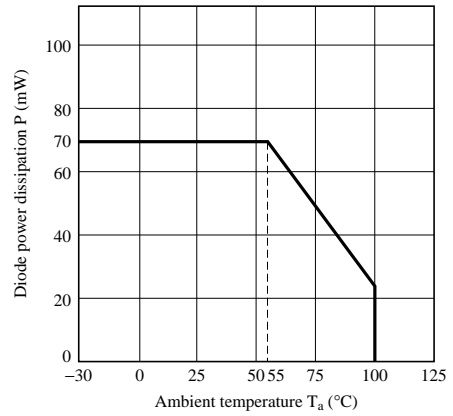

**Fig.4 Collector Power Dissipation vs. Ambient Temperature**

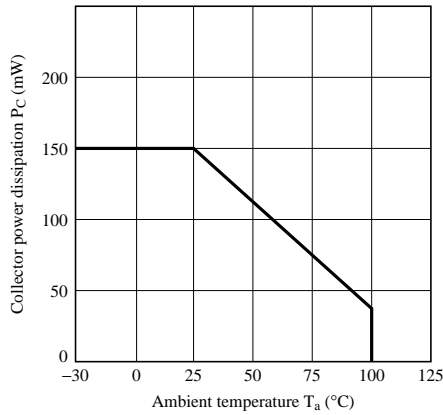

**Fig.5 Total Power Dissipation vs. Ambient Temperature**

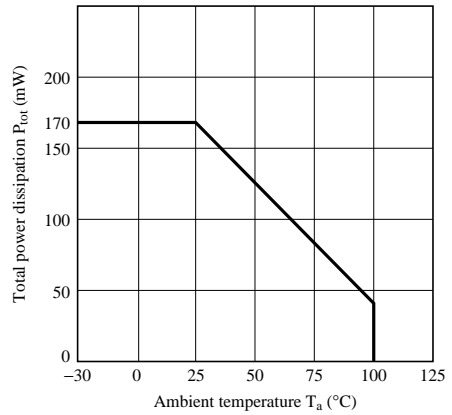

**Fig.6 Peak Forward Current vs. Duty Ratio**

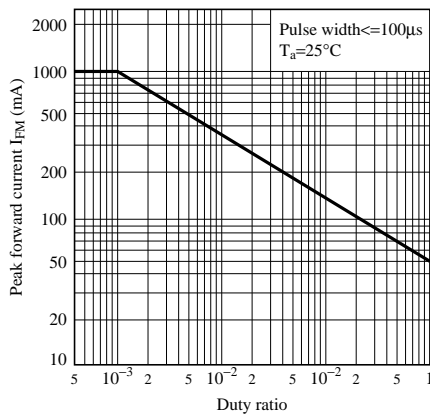

**Fig.7 Forward Current vs. Forward Voltage**

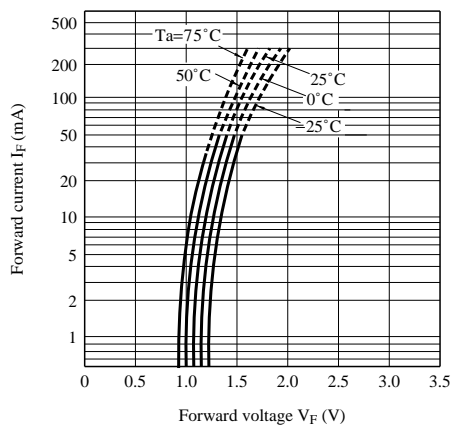

**Fig.8 Current Transfer Ratio vs. Forward Current**

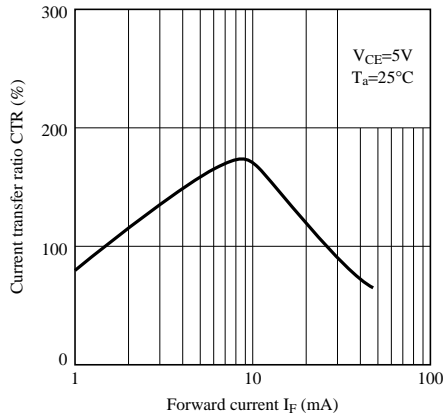

**Fig.9 Collector Current vs. Collector-emitter Voltage**

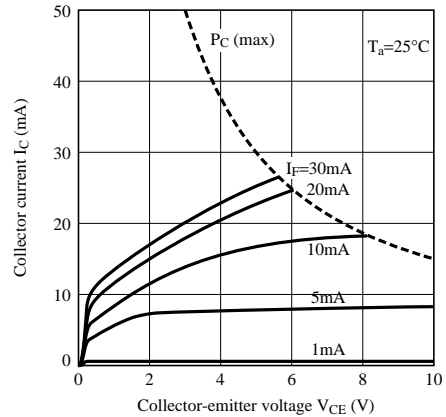

**Fig.10 Relative Current Transfer Ratio vs. Ambient Temperature**

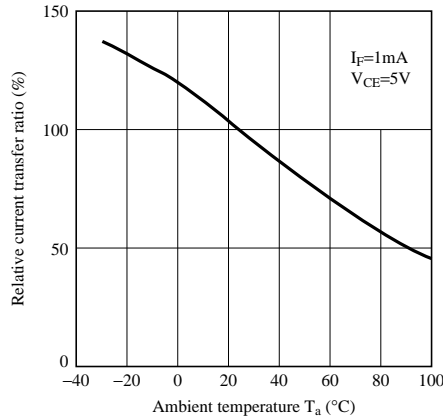

**Fig.11 Collector-emitter Saturation Voltage vs. Ambient Temperature**

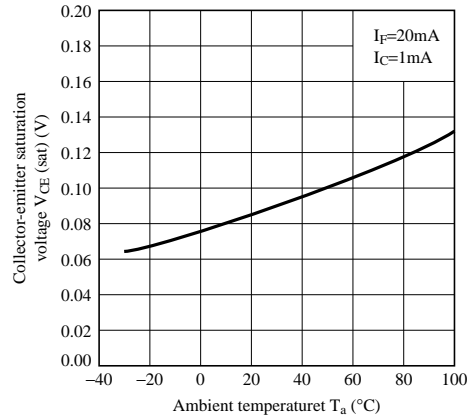

**Fig.12 Collector Dark Current vs. Ambient Temperature**

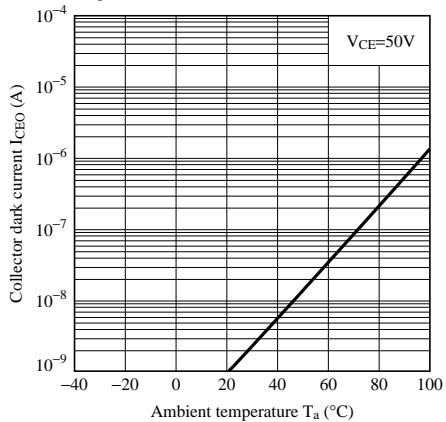

**Fig.13 Response Time vs. Load Resistance**

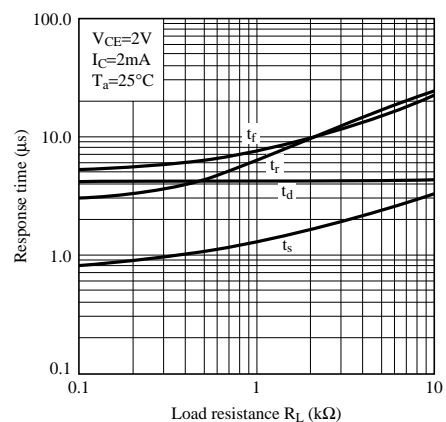

Fig.14 Test Circuit For Response Time

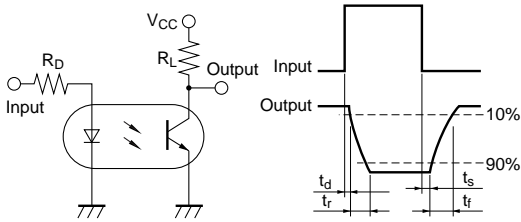

Fig.15 Voltage Gain vs Frequency

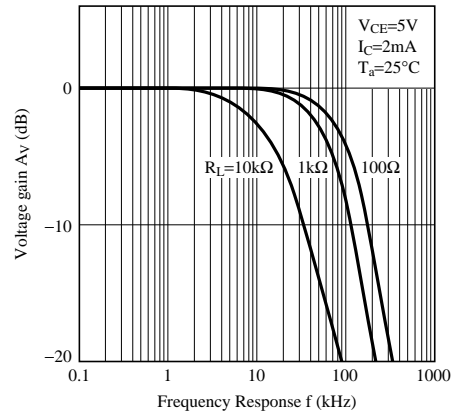

Fig.16 Collector-emitter Saturation Voltage vs. Forward Current

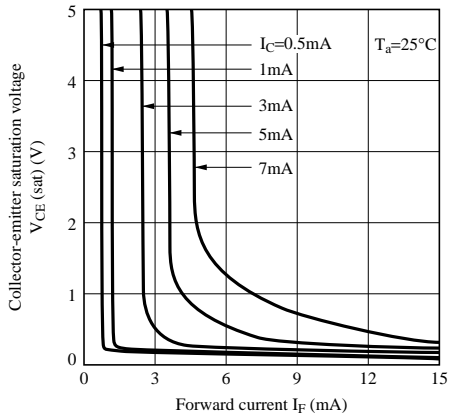
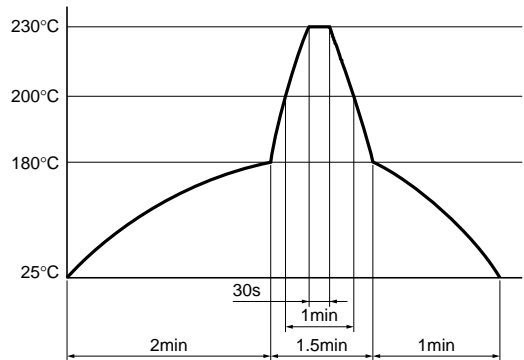

Fig.17 Reflow Soldering

Only one time soldering is recommended within the temperature profile shown below.



### NOTICE

- The circuit application examples in this publication are provided to explain representative applications of SHARP devices and are not intended to guarantee any circuit design or license any intellectual property rights. SHARP takes no responsibility for any problems related to any intellectual property right of a third party resulting from the use of SHARP's devices.
- Contact SHARP in order to obtain the latest device specification sheets before using any SHARP device. SHARP reserves the right to make changes in the specifications, characteristics, data, materials, structure, and other contents described herein at any time without notice in order to improve design or reliability. Manufacturing locations are also subject to change without notice.
- Observe the following points when using any devices in this publication. SHARP takes no responsibility for damage caused by improper use of the devices which does not meet the conditions and absolute maximum ratings to be used specified in the relevant specification sheet nor meet the following conditions:
  - (i) The devices in this publication are designed for use in general electronic equipment designs such as:
    - Personal computers
    - Office automation equipment
    - Telecommunication equipment [terminal]
    - Test and measurement equipment
    - Industrial control
    - Audio visual equipment
    - Consumer electronics
  - (ii) Measures such as fail-safe function and redundant design should be taken to ensure reliability and safety when SHARP devices are used for or in connection with equipment that requires higher reliability such as:
    - Transportation control and safety equipment (i.e., aircraft, trains, automobiles, etc.)
    - Traffic signals
    - Gas leakage sensor breakers
    - Alarm equipment
    - Various safety devices, etc.
  - (iii) SHARP devices shall not be used for or in connection with equipment that requires an extremely high level of reliability and safety such as:
    - Space applications
    - Telecommunication equipment [trunk lines]
    - Nuclear power control equipment
    - Medical and other life support equipment (e.g., scuba).
- Contact a SHARP representative in advance when intending to use SHARP devices for any "specific" applications other than those recommended by SHARP or when it is unclear which category mentioned above controls the intended use.
- If the SHARP devices listed in this publication fall within the scope of strategic products described in the Foreign Exchange and Foreign Trade Control Law of Japan, it is necessary to obtain approval to export such SHARP devices.
- This publication is the proprietary product of SHARP and is copyrighted, with all rights reserved. Under the copyright laws, no part of this publication may be reproduced or transmitted in any form or by any means, electronic or mechanical, for any purpose, in whole or in part, without the express written permission of SHARP. Express written permission is also required before any use of this publication may be made by a third party.
- Contact and consult with a SHARP representative if there are any questions about the contents of this publication.