

FEATURES

- **High Current Transfer Ratio**
CNY17-1, 40 to 80%
CNY17-2, 63 to 125%
CNY17-3, 100 to 200%
CNY17-4, 160 to 320%
- **Breakdown Voltage, 5300 V_{RMS}**
- **Field-Effect Stable by TRIOS—TRansparent IOn Shield**
- **Long Term Stability**
- **Industry Standard Dual-in-Line Package**
- **Underwriters Lab File #E52744**
- **VDE #0884, Available with Option 1**

DESCRIPTION

The CNY17 is an optically coupled pair consisting of a Gallium Arsenide infrared emitting diode optically coupled to a silicon NPN phototransistor.

Signal information, including a DC level, can be transmitted by the device while maintaining a high degree of electrical isolation between input and output.

The CNY17 can be used to replace relays and transformers in many digital interface applications, as well as analog applications such as CRT modulation.

Maximum Ratings ($T_A=25^\circ\text{C}$)
Emitter

Reverse Voltage 6.0 V
 Forward Current 60 mA
 Surge Current ($t \leq 10 \mu\text{s}$) 2.5 A
 Power Dissipation 100 mW

Detector

Collector-Emitter Breakdown Voltage 70 V
 Emitter-Base Breakdown Voltage 7.0 V
 Collector Current 50 mA
 Collector Current ($t < 1.0 \text{ ms}$) 100 mA
 Power Dissipation 150 mW

Package

Isolation Test Voltage (between emitter & detector referred to climate DIN 50014, part 2, Nov. 74) ($t=1 \text{ sec}$) 5300 V_{RMS}
 Creepage Distance $\geq 7.0 \text{ mm}$
 Clearance Distance $\geq 7.0 \text{ mm}$
 Isolation Thickness between
 Emitter and Detector $\geq 0.4 \text{ mm}$
 Comparative Tracking Index per DIN IEC 112/
 VDE0303, part 1 175
 Isolation Resistance
 $V_{IO}=500 \text{ V}, T_A=25^\circ\text{C}$ $\geq 10^{12} \Omega$
 $V_{IO}=500 \text{ V}, T_A=100^\circ\text{C}$ $\geq 10^{11} \Omega$
 Storage Temperature -55°C to $+150^\circ\text{C}$
 Operating Temperature -55°C to $+100^\circ\text{C}$
 Junction Temperature 100°C
 Soldering Temperature (max. 10 s, dip soldering:
 distance to seating plane $\geq 1.5 \text{ mm}$) 260°C

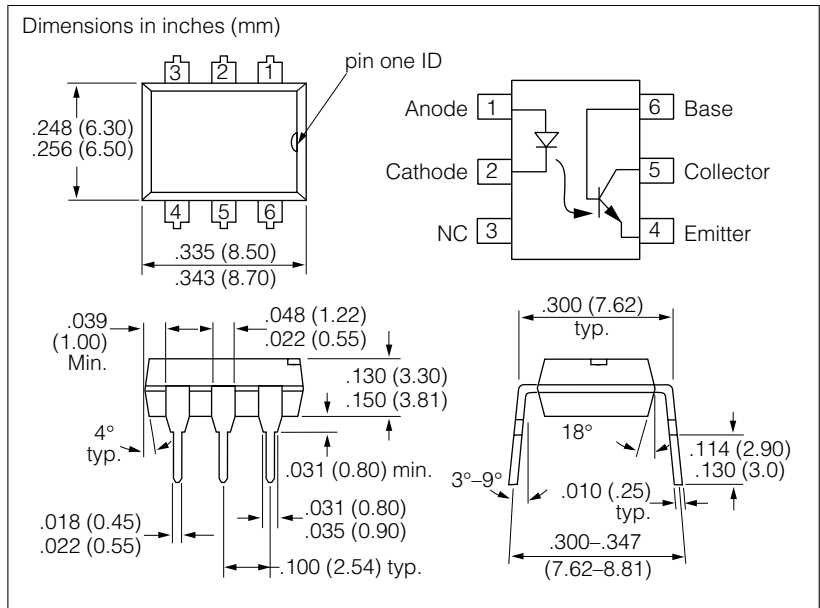

Characteristics ($T_A=25^\circ\text{C}$)

Parameter	Symbol	Values	Unit	Condition
Emitter				
Forward Voltage	V_F	1.25 (≤ 1.65)	V	$I_F = 60 \text{ mA}$
Breakdown Voltage	V_{BR}	≥ 6.0		$I_R = 10 \text{ mA}$
Reverse Current	I_R	0.01 (≤ 10)	μA	$V_R = 6.0 \text{ V}$
Capacitance	—	25	pF	$V_R=0 \text{ V}, f=1.0 \text{ MHz}$
Thermal Resistance	R_{thjamb}	750	K/W	—
Detector				
Capacitance	C_{CE} C_{CB} C_{EB}	5.2 6.5 7.5	pF	$V_{CE}=5.0 \text{ V}, f=1.0 \text{ MHz}$ $V_{CB}=5.0 \text{ V}, f=1.0 \text{ MHz}$ $V_{EB}=5.0 \text{ V}, f=1.0 \text{ MHz}$
Thermal Resistance	R_{thjamb}	500	K/W	—
Package				
Collector-Emitter Saturation Voltage	V_{CEsat}	0.25 (≤ 0.4)	V	$I_F = 10 \text{ mA}, I_C = 2.5 \text{ mA}$
Coupling Capacitance	C_C	0.6	pF	—

Current Transfer Ratio and Collector-Emitter Leakage Current by dash number ($T_A=25^\circ\text{C}$)

	-1	-2	-3	-4	Unit
I_C/I_F at $V_{CE}=5.0\text{ V}$ ($I_F=10\text{ mA}$)	40-80	63-125	100-200	160-320	%
I_C/I_F at $V_{CE}=5.0\text{ V}$ ($I_F=1.0\text{ mA}$)	30 (>13)	45 (>22)	70 (>34)	90 (>56)	%
Collector-Emitter Leakage Current ($V_{CE}=10\text{ V}$) (I_{CEO})	2.0 (≤ 50)	2.0 (≤ 50)	5.0 (≤ 100)	5.0 (≤ 100)	nA

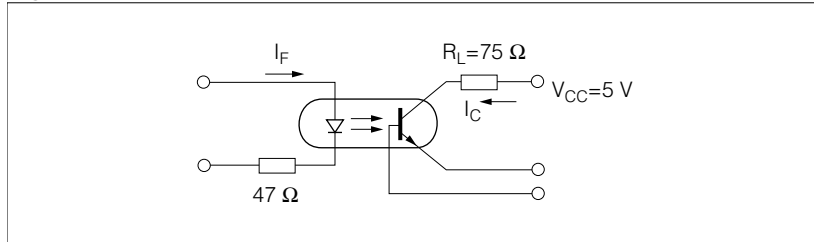
Figure 1. Linear Operation (without saturation)



$I_F=10\text{ mA}$, $V_{CC}=5.0\text{ V}$, $T_A=25^\circ\text{C}$

Load Resistance	R_L	75	W
Turn-On Time	t_{ON}	3.0	μs
Rise Time	t_r	2.0	μs
Turn-Off Time	t_{OFF}	2.3	μs
Fall Time	t_f	2.0	μs
Cut-off Frequency	f_{CO}	250	kHz

Figure 2. Switching Operation (with saturation)

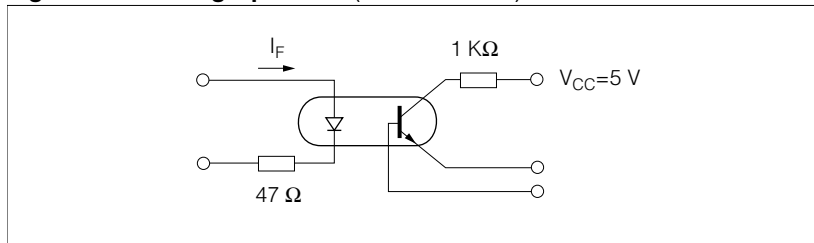

		-1 ($I_F=20\text{ mA}$)	-2 and -3 ($I_F=10\text{ mA}$)	-4 ($I_F=5.0\text{ mA}$)	
Turn-On Time	t_{ON}	3.0	4.2	6.0	μs
Rise Time	t_r	2.0	3.0	4.6	μs
Turn-Off Time	t_{OFF}	18	23	25	μs
Fall Time	t_f	11	14	15	μs

Figure 3. Current transfer ratio versus diode current ($T_A=-25^\circ\text{C}$, $V_{CE}=5.0\text{ V}$)

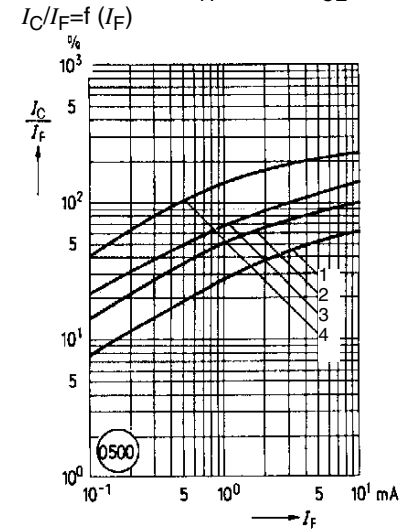

Figure 4. Current transfer ratio versus diode current ($T_A=0^\circ\text{C}$, $V_{CE}=5.0\text{ V}$)

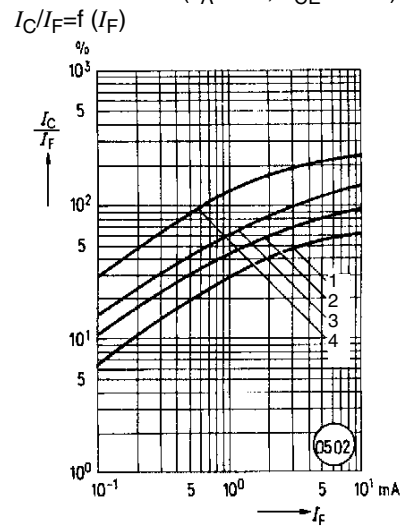

Figure 5. Current transfer ratio versus diode current ($T_A=25^\circ\text{C}$, $V_{CE}=5.0\text{ V}$)

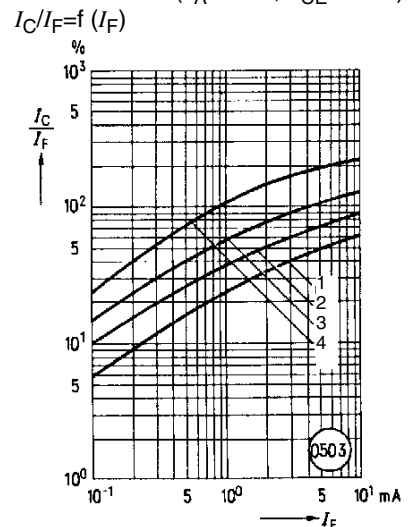

Figure 6. Current transfer ratio versus diode current ($T_A=50^\circ\text{C}$)

$V_{CE}=5.0\text{ V}$, $I_C/I_F=f(I_F)$

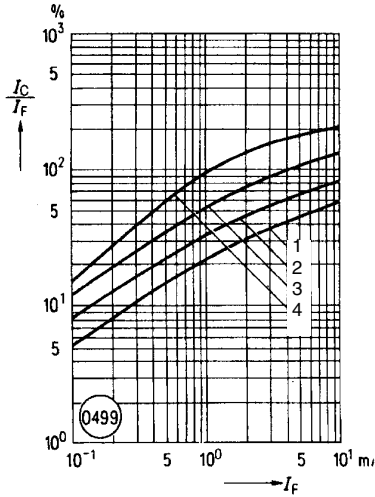

Figure 7. Current transfer ratio versus diode current ($T_A=75^\circ\text{C}$) $V_{CE}=5.0\text{ V}$

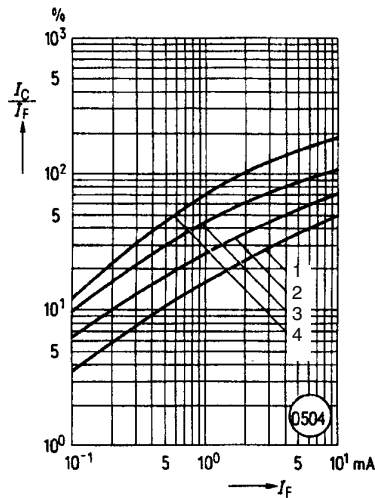

Figure 8. Current transfer ratio versus temperature ($I_F=10\text{ mA}$, $V_{CE}=5.0\text{ V}$)

$I_C/I_F=f(T)$

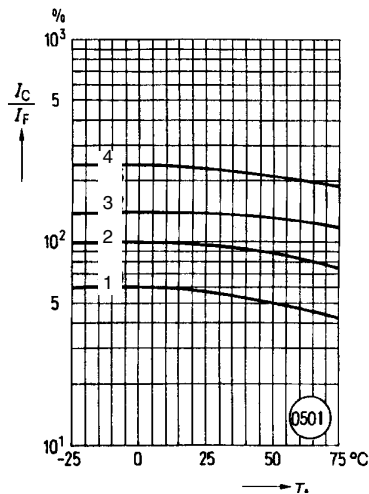

Figure 9. Transistor characteristics (B=550) CNY17-3, -4 $I_C=f(V_{CE})$

($T_A=25^\circ\text{C}$, $I_F=0$)

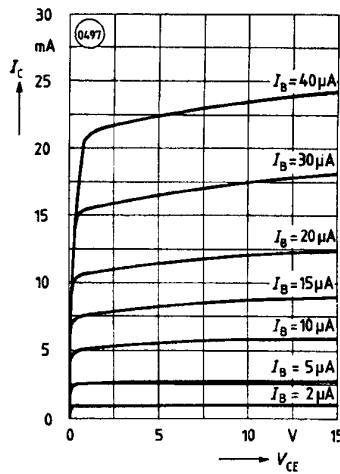

Figure 10. Output characteristics CNY17-3, -4 ($T_A=25^\circ\text{C}$) $I_C=f(V_{CE})$

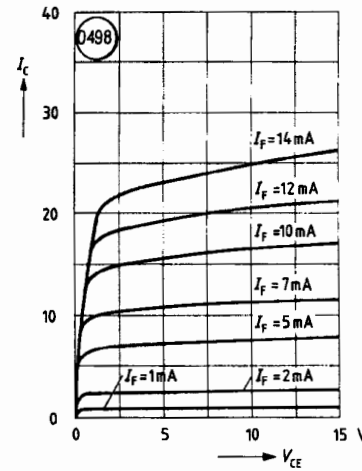

Figure 11. Forward voltage $V_F=f(I_F)$

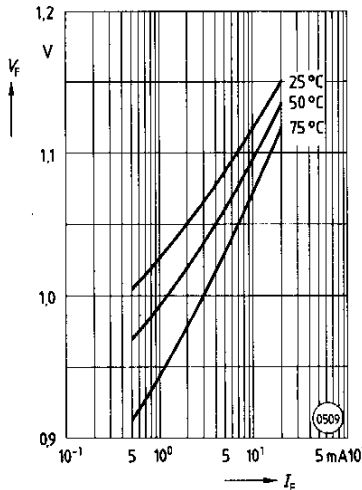

Figure 12. Collector emitter off-state current $I_{CEO}=f(V, T)$ ($T_A=25^\circ\text{C}$, $I_F=0$)

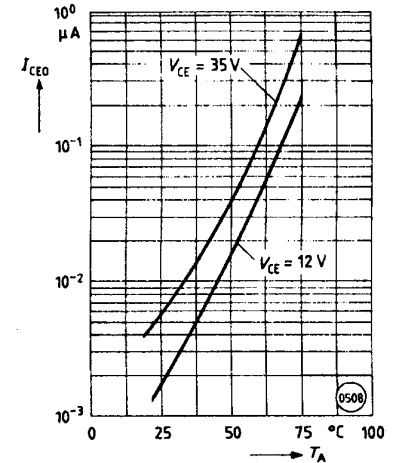

Figure 13. Saturation voltage versus collector current and modulation depth CNY17-1 $V_{CEsat}=f(I_C)$ ($T_A=25^\circ\text{C}$)

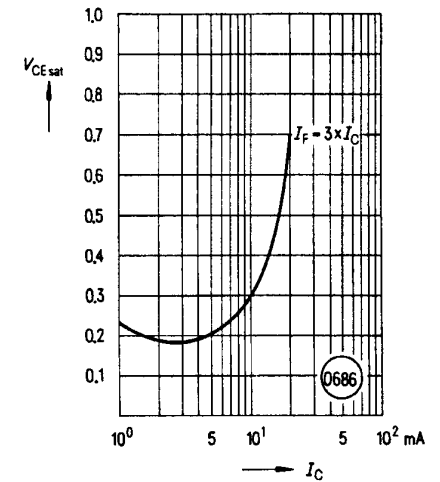

Figure 14. Saturation voltage versus collector current and modulation depth CNY17-2 $V_{CEsat}=f(I_C)$

($T_A=25^\circ\text{C}$)

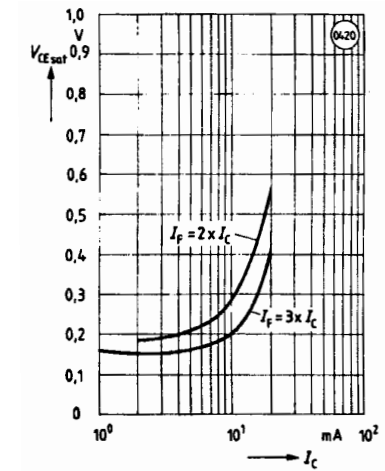

Figure 15. Saturation voltage versus collector current and modulation depth CNY17-3 $V_{CEsat}=f(I_C)$ ($T_A=25^\circ\text{C}$)

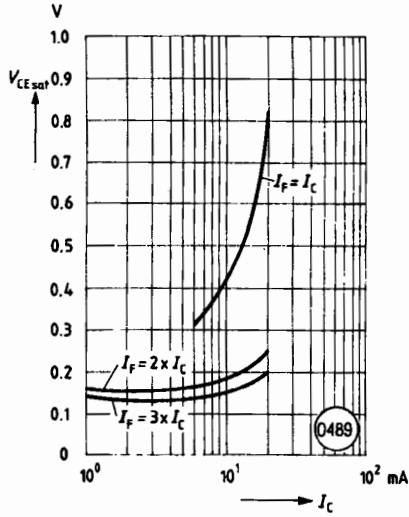

Figure 16. Saturation voltage versus collector current and modulation depth CNY17-4 $V_{CEsat}=f(I_C)$ ($T_A=25^\circ\text{C}$)

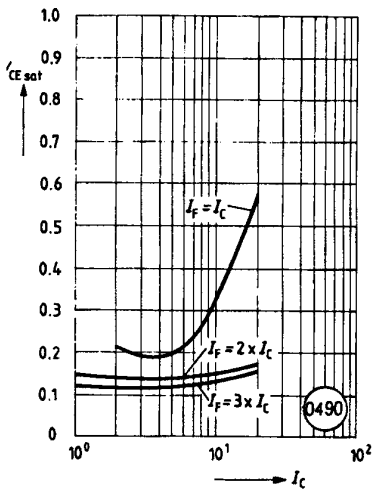

Figure 17. Permissible pulse load $D=\text{parameter}$, $T_A=25^\circ\text{C}$, $I_F=f(t_p)$

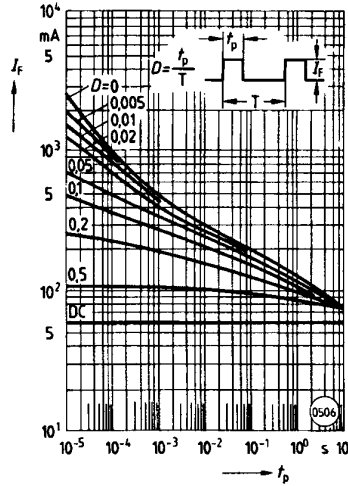

Figure 18. Permissible power dissipation transistor and diode $P_{tot}=f(T_A)$

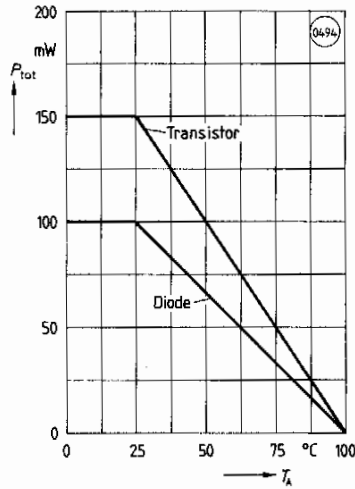

Figure 19. Permissible forward current $P_{tot}=f(T_A)$

