

CNC1S171 (ON3171)

Optoisolator

For isolated signal transmission

Features

- High current transfer ratio : CTR >50%
- High I/O isolation voltage :
 $V_{ISO} = 5000 V_{rms}$ (min.)
- Fast response :
 $t_r = 2 \mu s$, $t_f = 3 \mu s$ (typ.)
- Low dark current : $I_{CEO} < 100nA$
- VDE approved (VDE0884)
- UL listed (No. E79920)
- BSI certified
(BS415 No. 7889, BS7002 No. 7890)
- SEMKO certified (No. 9625004)
- DEMKO certified (No. 305848)
- NEMKO certified (No. 199633176)
- FIMKO certified (No. 191784)
- CSA approved (No. CA109151)

Absolute Maximum Ratings (Ta = 25°C)

Parameter		Symbol	Ratings	Unit
Input (Light emitting diode)	Reverse voltage (DC)	V_R	6	V
	Forward current (DC)	I_F	50	mA
	Pulse forward current	I_{FP}^{*1}	1	A
	Power dissipation	P_D^{*2}	75	mW
Output (Photo transistor)	Collector current	I_C	50	mA
	Collector to emitter voltage	V_{CEO}	80	V
	Emitter to collector voltage	V_{ECO}	7	V
	Collector power dissipation	P_C^{*3}	150	mW
Isolation voltage, input to output		V_{ISO}	5000	V_{rms}
Total power dissipation		P_T	200	mW
Operating ambient temperature		T_{opr}	-30 to +100	°C
Storage temperature		T_{stg}	-55 to +125	°C

Electrical Characteristics (Ta = 25°C)

Parameter		Symbol	Conditions	min	typ	max	Unit
Input characteristics	Reverse current (DC)	I_R	$V_R = 3V$			10	μA
	Forward voltage (DC)	V_F	$I_F = 50mA$		1.35	1.5	V
	Capacitance between pins	C_t	$V_R = 0V$, $f = 1MHz$			15	pF
Output characteristics	Collector cutoff current	I_{CEO}	$V_{CE} = 20V$		5	100	nA
	Collector to emitter voltage	V_{CEO}	$I_C = 100\mu A$	80			V
	Collector to emitter capacitance	C_C	$V_{CE} = 10V$, $f = 1MHz$		10		pF
Transfer characteristics	DC current transfer ratio	CTR ^{*1*}	$V_{CE} = 10V$, $I_F = 5mA$	50		600	%
	Isolation voltage, input to output	V_{ISO}	$t = 1 min.$, $RH < 60\%$	5000			V_{rms}
	Isolation capacitance, input to output	C_{ISO}	$f = 1MHz$		0.7		pF
	Isolation resistance, input to output	R_{ISO}	$V_{ISO} = 500V$	10^{11}			Ω
	Rise time	t_r^{*2}	$V_{CC} = 10V$, $I_C = 5mA$,		2		μs
	Fall time	t_f^{*3}	$R_L = 100\Omega$		3		μs
Collector to emitter saturation voltage	$V_{CE(sat)}$	$I_F = 20mA$, $I_C = 1mA$		0.1	0.2	V	

*1 DC current transfer ratio (CTR) is a ratio of output current against DC input current.

*2 t_r : Time required for the collector current to increase from 10% to 90% of its final value

*3 t_f : Time required for the collector current to decrease from 90% to 10% of its initial value

Note) The part number in the parenthesis shows conventional part number.

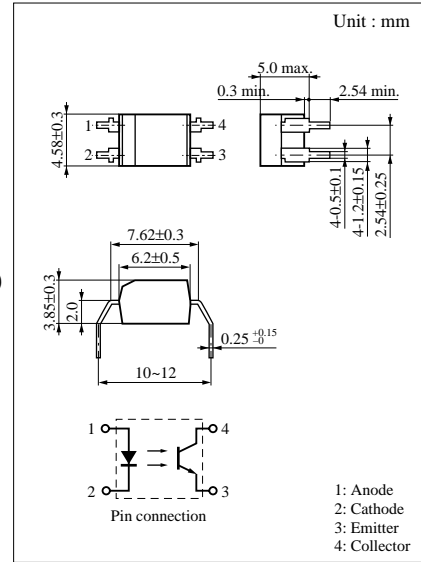

*1 Pulse width $\leq 100 \mu s$, repeat 100 pps

*2 Input power derating ratio is
0.75 mW/°C at $T_a \geq 25^\circ C$.

*3 Output power derating ratio is
1.5 mW/°C at $T_a \geq 25^\circ C$.

*4 CTR classifications

Class	Q	R	S
CTR (%)	50 to 120	100 to 250	200 to 600

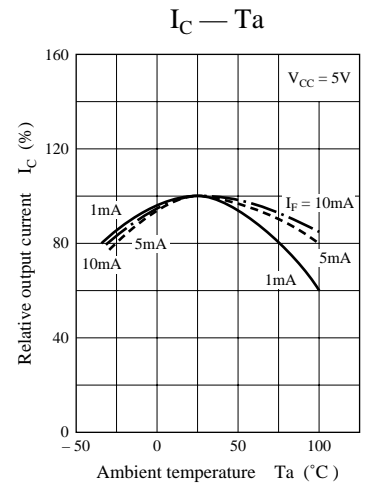
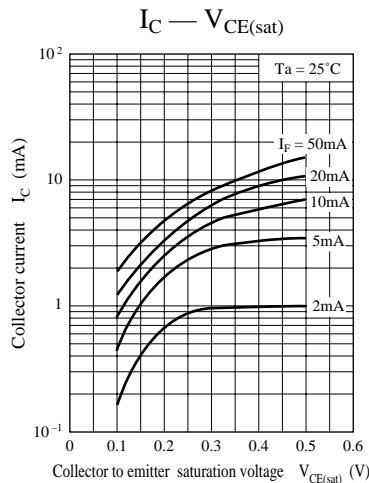
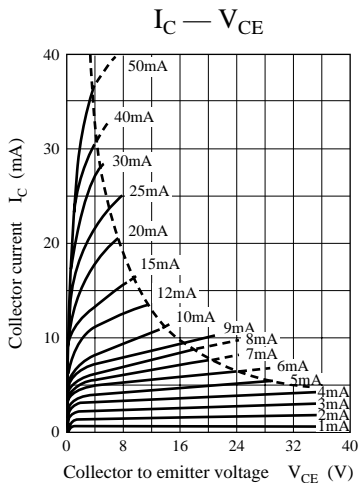
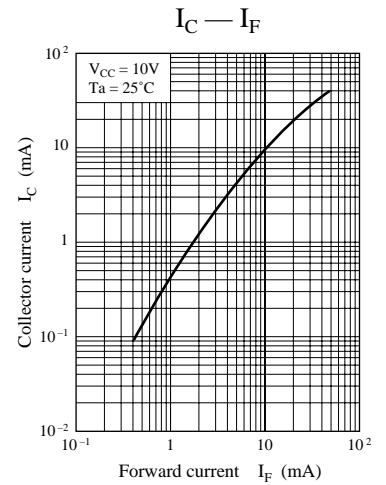
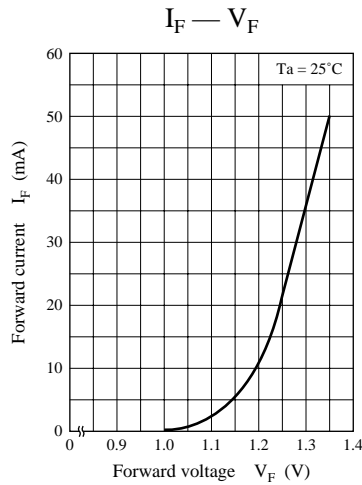
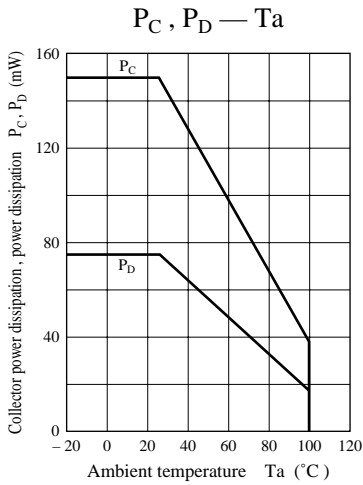

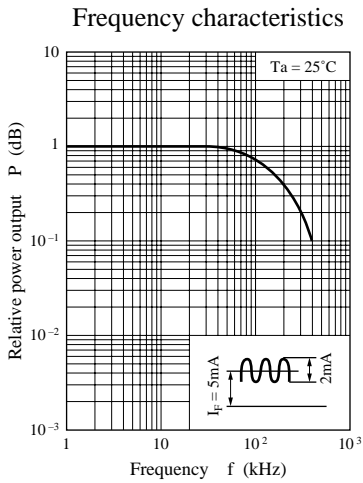
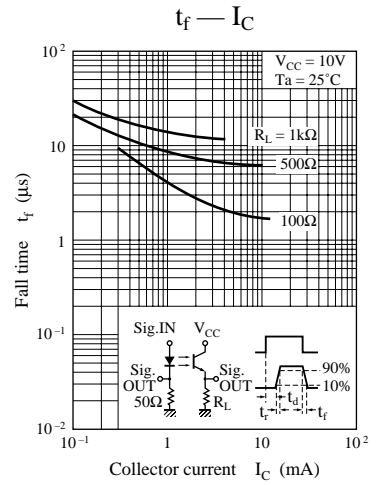
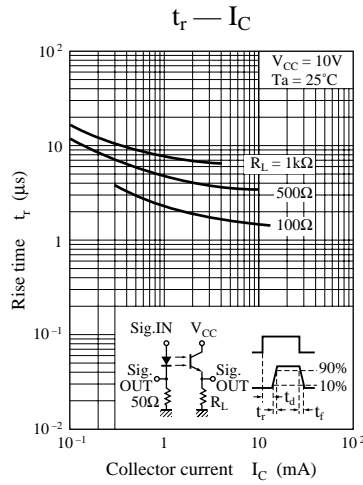
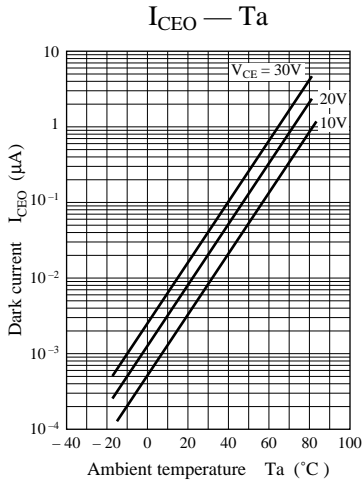

Measurement circuit of frequency characteristics

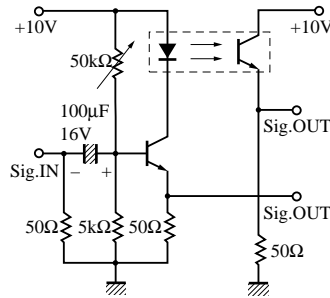

Caution for Safety

 **DANGER**

Gallium arsenide material (GaAs) is used in this product.

Therefore, do not burn, destroy, cut, crush, or chemically decompose the product, since gallium arsenide material in powder or vapor form is harmful to human health.

Observe the relevant laws and regulations when disposing of the products. Do not mix them with ordinary industrial waste or household refuse when disposing of GaAs-containing products.

Request for your special attention and precautions in using the technical information and semiconductors described in this material

- (1) An export permit needs to be obtained from the competent authorities of the Japanese Government if any of the products or technologies described in this material and controlled under the "Foreign Exchange and Foreign Trade Law" is to be exported or taken out of Japan.
- (2) The technical information described in this material is limited to showing representative characteristics and applied circuit examples of the products. It does not constitute the warranting of industrial property, the granting of relative rights, or the granting of any license.
- (3) The products described in this material are intended to be used for standard applications or general electronic equipment (such as office equipment, communications equipment, measuring instruments and household appliances).
Consult our sales staff in advance for information on the following applications:
 - Special applications (such as for airplanes, aerospace, automobiles, traffic control equipment, combustion equipment, life support systems and safety devices) in which exceptional quality and reliability are required, or if the failure or malfunction of the products may directly jeopardize life or harm the human body.
 - Any applications other than the standard applications intended.
- (4) The products and product specifications described in this material are subject to change without notice for reasons of modification and/or improvement. At the final stage of your design, purchasing, or use of the products, therefore, ask for the most up-to-date Product Standards in advance to make sure that the latest specifications satisfy your requirements.
- (5) When designing your equipment, comply with the guaranteed values, in particular those of maximum rating, the range of operating power supply voltage and heat radiation characteristics. Otherwise, we will not be liable for any defect which may arise later in your equipment.
Even when the products are used within the guaranteed values, redundant design is recommended, so that such equipment may not violate relevant laws or regulations because of the function of our products.
- (6) When using products for which dry packing is required, observe the conditions (including shelf life and after-unpacking standby time) agreed upon when specification sheets are individually exchanged.
- (7) No part of this material may be reprinted or reproduced by any means without written permission from our company.

Please read the following notes before using the datasheets

- A. These materials are intended as a reference to assist customers with the selection of Panasonic semiconductor products best suited to their applications.
Due to modification or other reasons, any information contained in this material, such as available product types, technical data, and so on, is subject to change without notice.
Customers are advised to contact our semiconductor sales office and obtain the latest information before starting precise technical research and/or purchasing activities.
- B. Panasonic is endeavoring to continually improve the quality and reliability of these materials but there is always the possibility that further rectifications will be required in the future. Therefore, Panasonic will not assume any liability for any damages arising from any errors etc. that may appear in this material.
- C. These materials are solely intended for a customer's individual use.
Therefore, without the prior written approval of Panasonic, any other use such as reproducing, selling, or distributing this material to a third party, via the Internet or in any other way, is prohibited.