

FEATURES

- Very High Current Transfer Ratio, 500% Min.
- High Isolation Resistance, $10^{11} \Omega$ Typical
- Standard Plastic DIP Package
- Underwriters Lab File #E52744
- VDE Approvals #0884 (Available with Option 1)

DESCRIPTION

The 4N32 and 4N33 are optically coupled isolators with a Gallium Arsenide infrared LED and a silicon photodarlington sensor. Switching can be achieved while maintaining a high degree of isolation between driving and load circuits. These optocouplers can be used to replace reed and mercury relays with advantages of long life, high speed switching and elimination of magnetic fields.

Maximum Ratings

Emitter

Peak Reverse Voltage 3.0 V
 Continuous Forward Current 60 mA
 Power Dissipation at 25°C 100 mW
 Derate Linearly from 55°C 1.33 mW/°C

Detector

Collector-Emitter Breakdown Voltage, BV_{CEO} 30 V
 Emitter-Base Breakdown Voltage, BV_{EBO} 8.0 V
 Collector-Base Breakdown Voltage,
 BV_{CBO} 50 V
 Emitter-Collector Breakdown Voltage,
 BV_{ECO} 5.0 V
 Collector (load) Current 125 mA
 Power Dissipation at 25°C Ambient 150 mW
 Derate Linearly from 25°C 2.0 mW/°C

Package

Total Dissipation at 25°C Ambient 250 mW
 Derate Linearly from 25°C 3.3 mW/°C
 Isolation Test Voltage 5300 V_{RMS}
 (between emitter and detector,
 Standard Climate: 23°C/50%RH,
 DIN 50014)
 Leakage Path 7.0 mm min.
 Air Path 7.0 mm min.
 Isolation Resistance
 $V_{IO}=500 \text{ V}/25^\circ\text{C}$ $\geq 10^{12} \Omega$
 $V_{IO}=500 \text{ V}/100^\circ\text{C}$ $\geq 10^{11} \Omega$
 Storage Temperature -55°C to +150°C
 Operating Temperature -55°C to +100°C
 Lead Soldering Time at 260°C 10 s

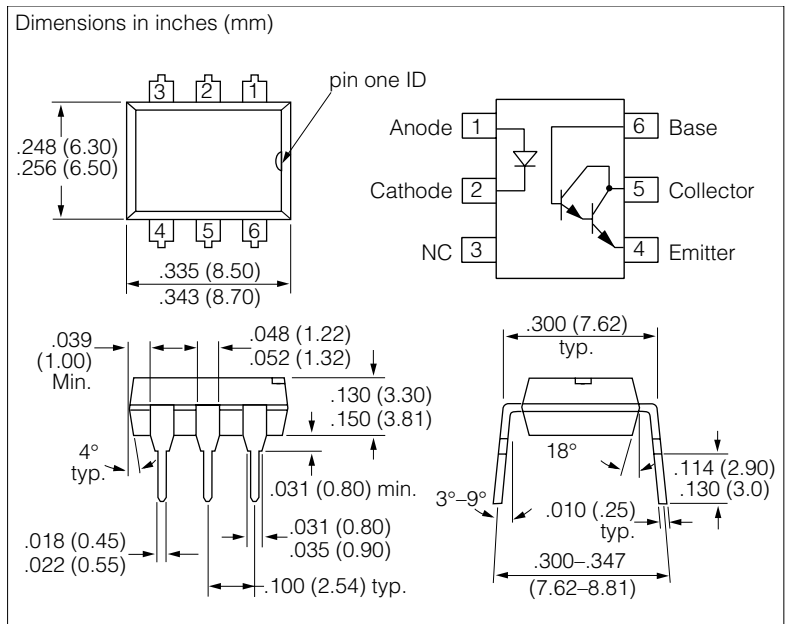

Electrical Characteristics $T_A=25^\circ\text{C}$

| Parameter | Min. | Typ. | Max. | Unit | Condition |
|------------------------|------|------|------|---------------|--------------------------------------------|
| Emitter | | | | | |
| Forward Voltage | — | 1.25 | 1.5 | V | $I_F=50 \text{ mA}$ |
| Reverse Current | 0.1 | 100 | — | μA | $V_R=3.0 \text{ V}$ |
| Capacitance | — | 25 | — | pF | $V_R=0 \text{ V}$ |
| Detector | | | | | |
| BV_{CEO}^* | 30 | — | — | V | $I_C=100 \mu\text{A}, I_F=0$ |
| BV_{CBO}^* | 50 | — | — | V | $I_C=100 \mu\text{A}, I_F=0$ |
| BV_{EBO}^* | 8.0 | — | — | V | $I_E=100 \mu\text{A}, I_F=0$ |
| BV_{ECO}^* | 5.0 | 10 | — | V | $I_E=100 \mu\text{A}, I_F=0$ |
| I_{CEO} | — | 1.0 | 100 | nA | $V_{CE}=10 \text{ V}, I_F=0$ |
| h_{FE} | — | 13K | — | — | $I_C=0.5 \text{ mA}, V_{CE}=5.0 \text{ V}$ |
| Package | | | | | |
| Current Transfer Ratio | 500 | — | — | % | $I_F=10 \text{ mA}, V_{CE}=10 \text{ V}$ |
| V_{CEsat} | — | 1.0 | — | V | $I_C=2.0 \text{ mA}, I_F=8.0 \text{ mA}$ |
| Coupling Capacitance | — | 1.5 | — | pF | — |
| Turn On Time | — | 5.0 | — | μs | $V_{CC}=10 \text{ V}, I_C=50 \text{ mA}$ |
| Turn Off Time | — | 100 | — | μs | $I_F=200 \text{ mA}, R_L=180 \Omega$ |

*Indicates JEDEC registered values

Figure 1. Forward Voltage versus Forward Current

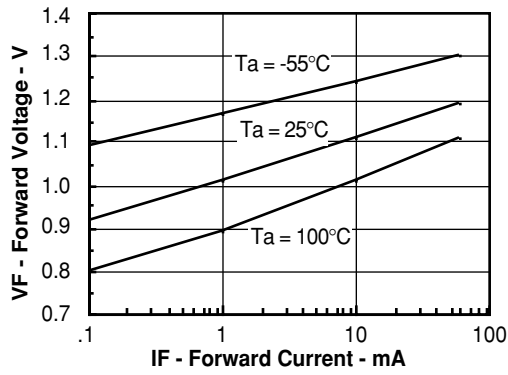

Figure 2. Normalized Non-saturated and Saturated CTR_{Rce} versus LED Current

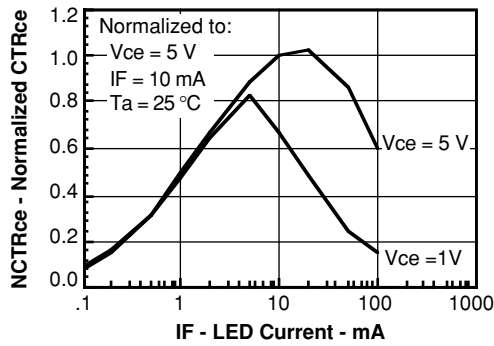

Figure 3. Normalized non-saturated and Saturated Collector-emitter Current versus LED Current

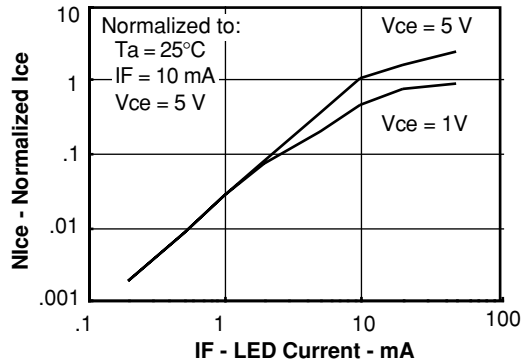

Figure 4. Normalized Collector-base Photocurrent versus LED Current

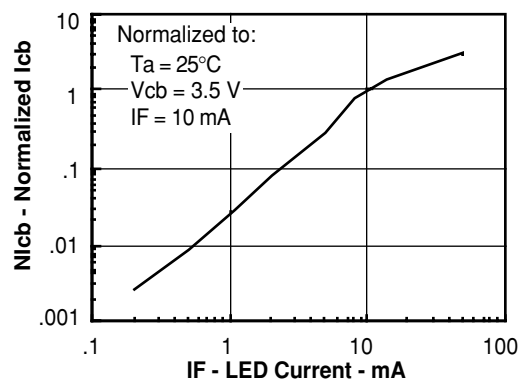

Figure 5. Non-saturated and Saturated HFE versus Base Current

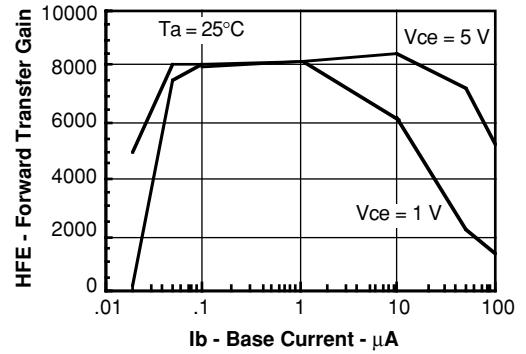

Figure 6. Low to High Propagation Delay versus Collector Load Resistance and LED Current

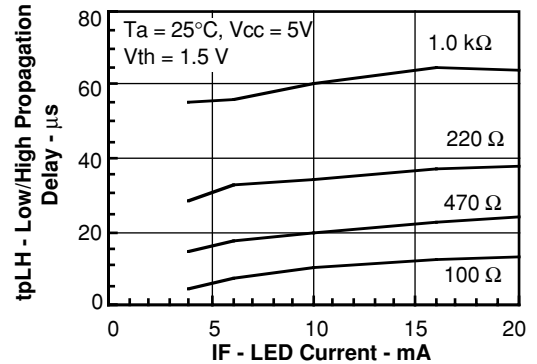

Figure 7. High to low Propagation Delay versus Collector Load Resistance and LED Current

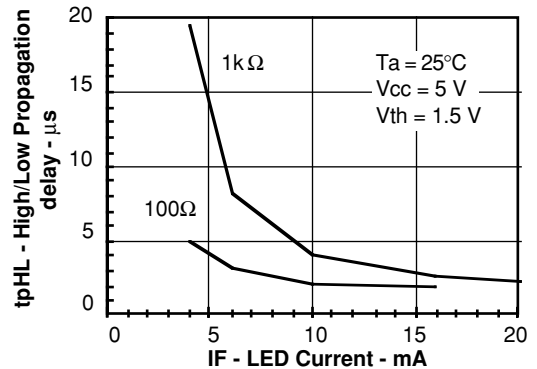

Figure 8. Switching Waveform and Switching Schematic

