

1 310 nm OPTICAL CATV RETURN PATH APPLICATIONS InGaAsP MQW DFB LASER DIODE MODULE WITH ISOLATOR

DESCRIPTION

The NDL7605P Series is a 1 310 nm uncooled isolated coaxial DFB laser diode. It is especially designed for optical CATV return path applications.

FEATURES

- Low distortion
 - IMD2 = -50 dBc MAX.*1 @ T_c = 25 °C
 - IMD2 = -45 dBc MAX.*1 @ T_c = -40 to +85 °C
 - IMD3 = -60 dBc MAX.*1 @ T_c = -40 to +85 °C
- Output power P_r = 2.0 mW
- Long wavelength λ_p = 1 310 nm
- Internal InGaAs monitor PD and isolator
- Single mode fiber pigtail with FC-UPC, SC-UPC or SC-APC connector
- Wide operating temperature range T_c = -40 to +85 °C

*1 2-ch, Optical loss = 7 dB, OMI = 10 %/ch

The information in this document is subject to change without notice. Before using this document, please confirm that this is the latest version.
Not all devices/types available in every country. Please check with local NEC representative for availability and additional information.

PACKAGE DIMENSIONS (in millimeters)

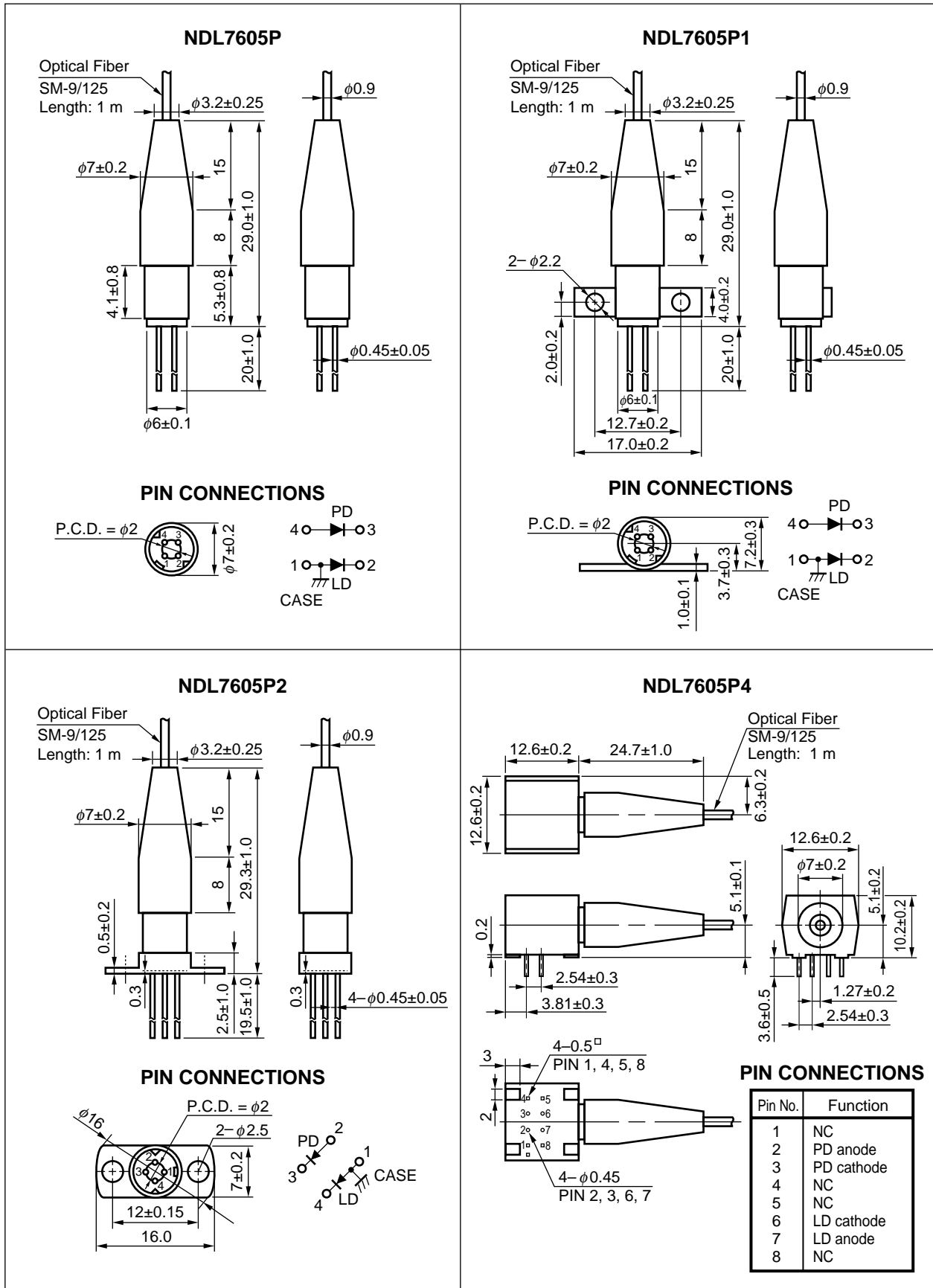

ORDERING INFORMATION

Part Number	Available Connector	Flange Type
NDL7605PC	With FC-UPC Connector	No Flange
NDL7605PD	With SC-UPC Connector	
NDL7605PX	With SC-APC Connector	
NDL7605P1C	With FC-UPC Connector	Flat Mount Flange
NDL7605P1D	With SC-UPC Connector	
NDL7605P1X	With SC-APC Connector	
NDL7605P2C	With FC-UPC Connector	Vertical Flange
NDL7605P2D	With SC-UPC Connector	
NDL7605P2X	With SC-APC Connector	
NDL7605P4C	With FC-UPC Connector	Lead Bend
NDL7605P4D	With SC-UPC Connector	
NDL7605P4X	With SC-APC Connector	

ABSOLUTE MAXIMUM RATINGS (T_c = 25 °C, unless otherwise specified)

Parameter	Symbol	Ratings	Unit
Optical Output Power from Fiber	P _f	5	mW
Forward Current of LD	I _F	I _{th} + 50	mA
Reverse Voltage of LD	V _R	2.0	V
Forward Current of PD	I _F	10	mA
Reverse Voltage of PD	V _R	15	V
Operating Case Temperature	T _C	-40 to +85	°C
Storage Temperature	T _{stg}	-40 to +85	°C
Lead Soldering Temperature (10 s)	T _{slid}	260	°C

ELECTRO-OPTICAL CHARACTERISTICS

(T_c = 25 °C, Optical Reflection ≤ -50 dB, unless otherwise specified)

Parameter	Symbol	Conditions	MIN.	TYP.	MAX.	Unit
Forward Voltage	V _F	I _F = 30 mA	0.9	1.1	1.3	V
Optical Output Power from Fiber	P _f	CW		2.0		mW
Threshold Current	I _{th}	CW		15	30	mA
		CW, T _c = 85 °C		40	60	
Differential Efficiency from Fiber	η _d	P _f = 2.0 mW	0.080	0.200		W/A
Temperature Dependence of Differential Efficiency from Fiber	Δη _d	P _f = 2.0 mW, η (85 °C) / η (25 °C)	-3.0			dB
Peak Emission Wavelength	λ _p	P _f = 2.0 mW, RMS (-20 dB)	1 290	1 310	1 330	nm
Side Mode Suppression Ratio	SMSR	P _f = 2.0 mW	30			dB
2nd Order Inter-modulation Distortion	IMD2	*1			-50	dBc
		*1, T _c = -40 to +85 °C			-45	
3rd Order Inter-modulation Distortion	IMD3	*1, T _c = -40 to +85 °C			-60	dBc
Carrier to Noise Ratio	CNR	*1, T _c = -40 to +85 °C	52			dB
Monitor Current	I _m	V _R = 5 V, P _f = 2.0 mW	100	500	1 000	μA
Dark Current	I _D	V _R = 5 V		0.1	10	nA
Tracking Error	γ ²	I _m = const., P _f = 2.0 mW, T _c = -40 to +85 °C			1.5	dB
Optical Isolation	ISO		30			dB

*1 Conditions: P_f = 2.0 mW, T_c = 25 °C, 2 channel unmodulated carriers 13 MHz and 19 MHz,
Optical Reflection = -50 dB, Optical Loss = 7 dB, OMI = 10 %/ch

*2 $\gamma = \left| 10 \log \frac{P_f}{2.0 \text{ mW}} \right|$

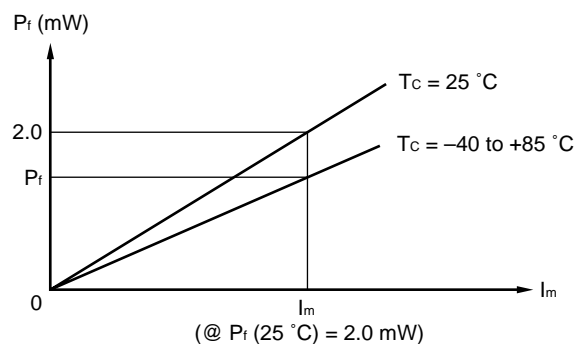

★ TYPICAL CHARACTERISTICS ($T_c = 25\text{ }^\circ\text{C}$, unless otherwise specified)

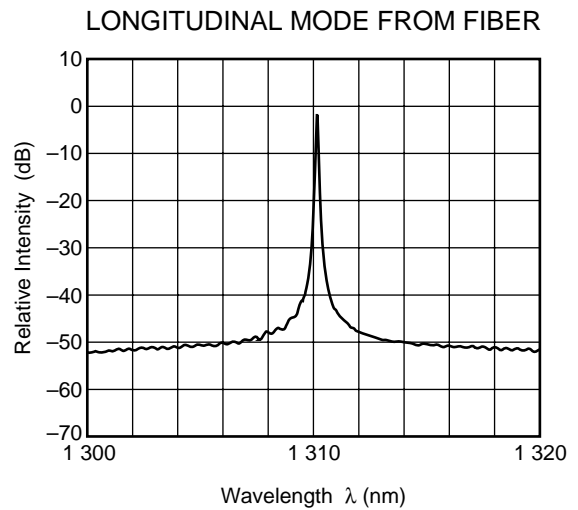
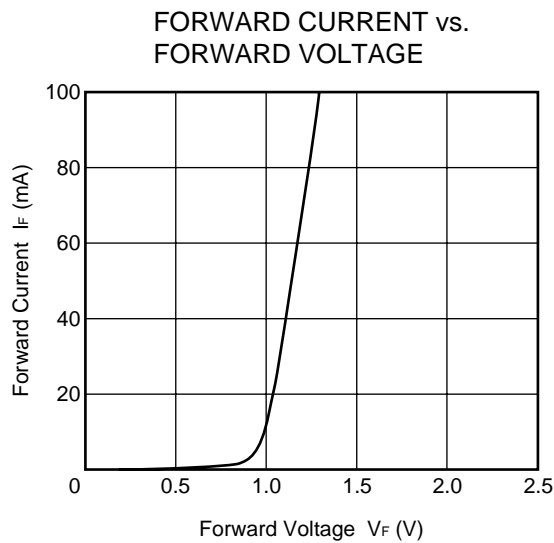
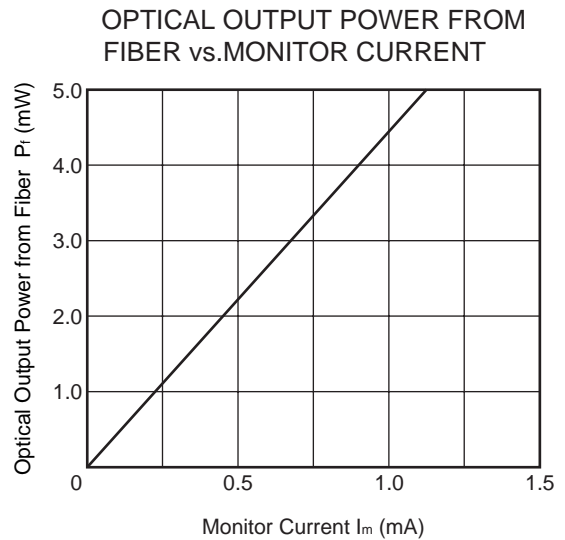
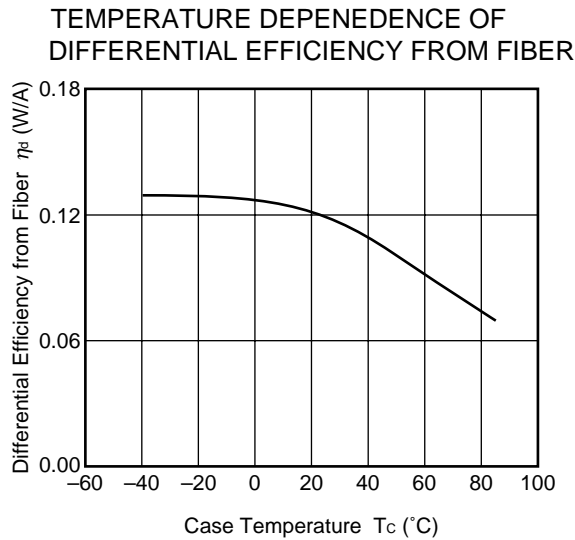
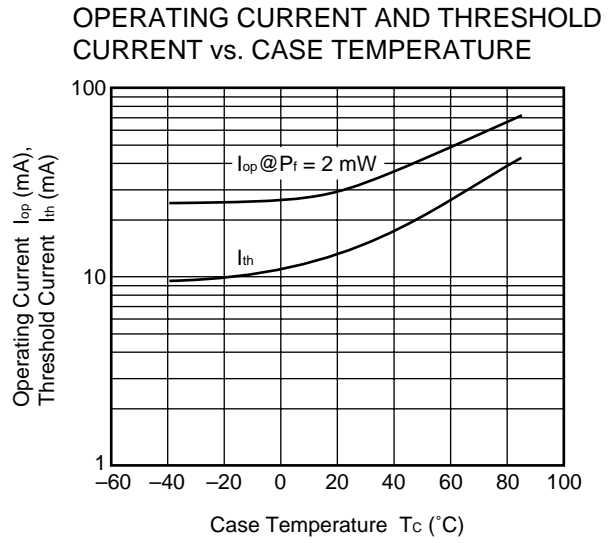
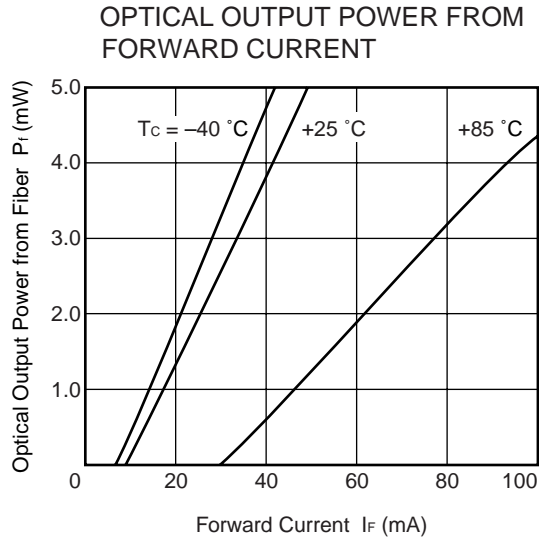

TEMPERATURE DEPENDENCE OF PEAK EMISSION WAVELENGTH

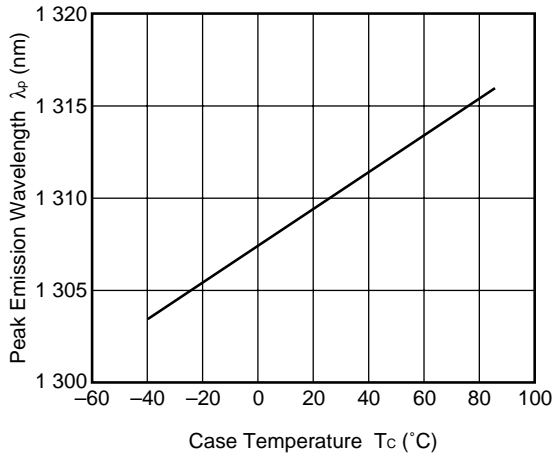

IMD2, IMD3, CNR vs. CASE TEMPERATURE

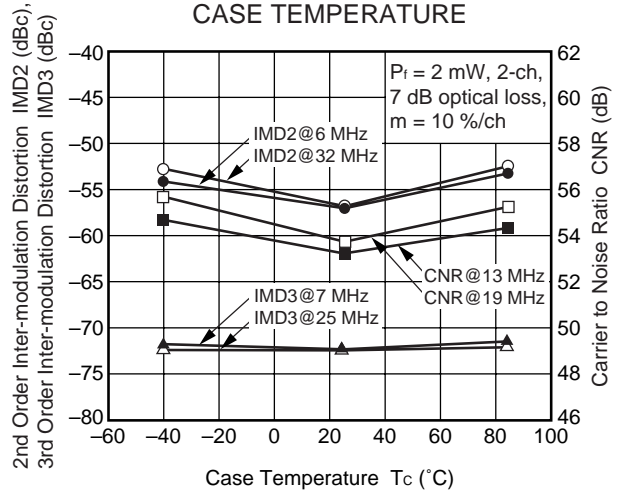

IMD2, IMD3, CNR vs. OPTICAL OUTPUT POWER FROM FIBER

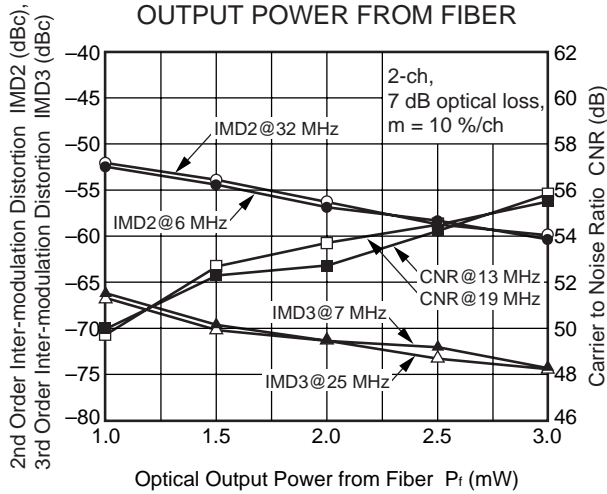

IMD2, IMD3, CNR vs. OPTICAL MODULATION INDEX

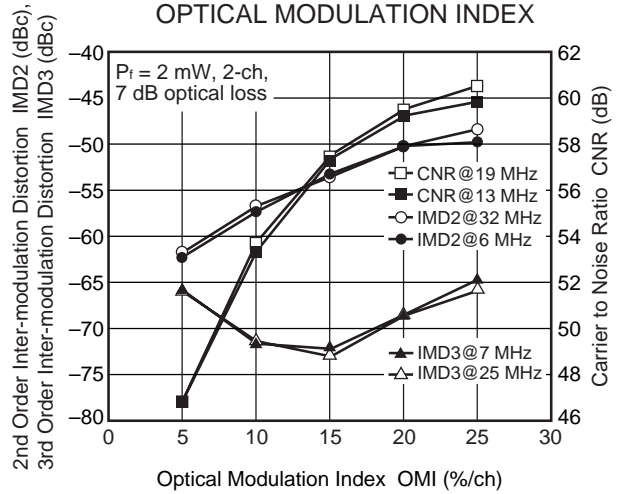

Remark The graphs indicate nominal characteristics.

★ **REFERENCE**

Document Name	Document No.
NEC semiconductor device reliability/quality control system	C11159E
Quality grades on NEC semiconductor devices	C11531E
Semiconductor device mounting technology manual	C10535E
SEMICONDUCTORS SELECTION GUIDE Products & Packages (CD-ROM)	X13769X

[MEMO]

[MEMO]

[MEMO]

CAUTION

Within this device there exists GaAs (Gallium Arsenide) material which is a harmful substance if ingested. Please do not under any circumstances break the hermetic seal.

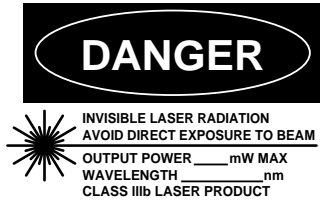

DANGER

INVISIBLE LASER RADIATION
AVOID DIRECT EXPOSURE TO BEAM

OUTPUT POWER _____ mW MAX
WAVELENGTH _____ nm
CLASS IIIb LASER PRODUCT

SEMICONDUCTOR LASER

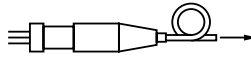

AVOID EXPOSURE-Invisible
Laser Radiation is emitted from
this aperture

NEC Corporation

NEC Building, 7-1, Shiba 5-chome,
Minato-ku, Tokyo 108-01, Japan

Type number: _____

Manufactured: _____

Serial Number: _____

This product conforms to FDA
regulations as applicable
to standards 21 CFR Chapter 1.
Subchapter J.

The export of this product from Japan is prohibited without governmental license. To export or re-export this product from a country other than Japan may also be prohibited without a license from that country. Please call an NEC sales representative.

- **The information in this document is subject to change without notice. Before using this document, please confirm that this is the latest version.**
 - No part of this document may be copied or reproduced in any form or by any means without the prior written consent of NEC Corporation. NEC Corporation assumes no responsibility for any errors which may appear in this document.
 - NEC Corporation does not assume any liability for infringement of patents, copyrights or other intellectual property rights of third parties by or arising from use of a device described herein or any other liability arising from use of such device. No license, either express, implied or otherwise, is granted under any patents, copyrights or other intellectual property rights of NEC Corporation or others.
 - Descriptions of circuits, software, and other related information in this document are provided for illustrative purposes in semiconductor product operation and application examples. The incorporation of these circuits, software, and information in the design of the customer's equipment shall be done under the full responsibility of the customer. NEC Corporation assumes no responsibility for any losses incurred by the customer or third parties arising from the use of these circuits, software, and information.
 - While NEC Corporation has been making continuous effort to enhance the reliability of its semiconductor devices, the possibility of defects cannot be eliminated entirely. To minimize risks of damage or injury to persons or property arising from a defect in an NEC semiconductor device, customers must incorporate sufficient safety measures in its design, such as redundancy, fire-containment, and anti-failure features.
 - NEC devices are classified into the following three quality grades:
"Standard", "Special", and "Specific". The Specific quality grade applies only to devices developed based on a customer designated "quality assurance program" for a specific application. The recommended applications of a device depend on its quality grade, as indicated below. Customers must check the quality grade of each device before using it in a particular application.
 - Standard: Computers, office equipment, communications equipment, test and measurement equipment, audio and visual equipment, home electronic appliances, machine tools, personal electronic equipment and industrial robots
 - Special: Transportation equipment (automobiles, trains, ships, etc.), traffic control systems, anti-disaster systems, anti-crime systems, safety equipment and medical equipment (not specifically designed for life support)
 - Specific: Aircraft, aerospace equipment, submersible repeaters, nuclear reactor control systems, life support systems or medical equipment for life support, etc.
- The quality grade of NEC devices is "Standard" unless otherwise specified in NEC's Data Sheets or Data Books. If customers intend to use NEC devices for applications other than those specified for Standard quality grade, they should contact an NEC sales representative in advance.