

Ordering number: EN 3410C

<b>SANYO</b>	No. 3410C	CMOS LSI
		<b>LC58E68</b>
<b>4-bit Microprocessor with Built-in EPROM and LCD Drivers</b>		

### Overview

The LC58E68 is a 4-bit microprocessor with built-in 16 Kbytes of EPROM, 1 Kbit of RAM and LCD drivers. It can perform most of the functions of the LC586X series single-chip microprocessors, making it ideal for prototyping systems based on these devices.

The LC58E68 features an additional 224 bytes of EPROM containing the configuration option data. Configuration options include input and output configurations and oscillator selection. Input configuration options are LOW-level hold transistor, HIGH-level hold transistor and no hold transistor enabled, and pull-up and pull-down input transistors. Output configuration options are LCD driver and CMOS, p-channel open-drain and n-channel open-drain general-purpose outputs. The oscillator options are ceramic filter, crystal, and both ceramic filter and crystal.

The LC58E68's UV-erasable EPROM can be re-programmed using a general-purpose PROM programmer and an adapter board.

The LC58E68 operates from a 3 or 5 V supply and is available in 80-pin QIPs.

### Features

- Compatible with the LC586X series mask ROM devices
- 16-Kbyte program EPROM
- 224-byte configuration EPROM
- 1-Kbit RAM
- LCD drivers
- 3 or 5 V supply
- 80-pin QIP

### Pin Assignment

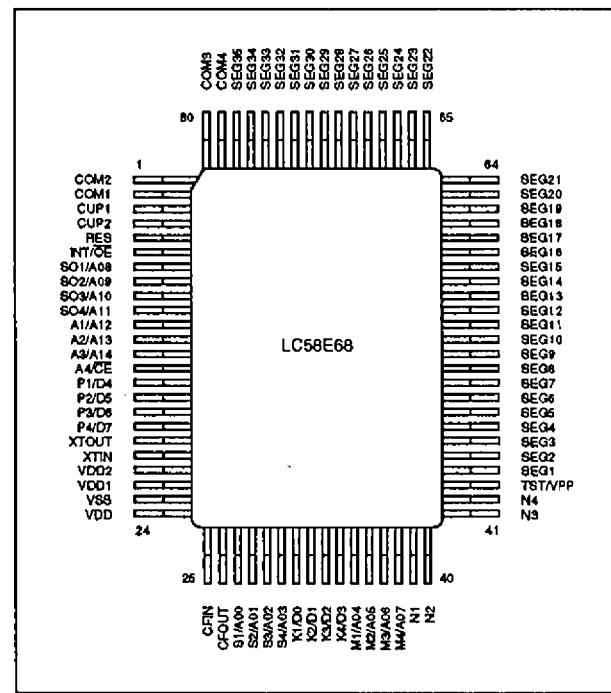

### Package Dimensions

Unit: mm

3152A-QFC80C

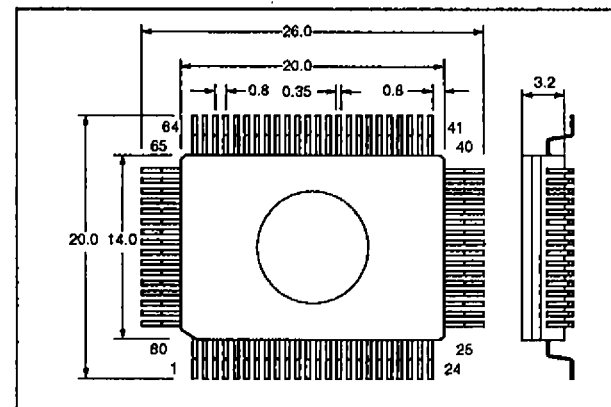

**SANYO Electric Co., Ltd. Semiconductor Business Headquarters**  
TOKYO OFFICE Tokyo Bldg., 1-10, 1 Chome, Ueno, Taito-ku, TOKYO, 110 JAPAN

11795TH (ID)/7142JN No. 3410-1/19

LC58E68

Block Diagram

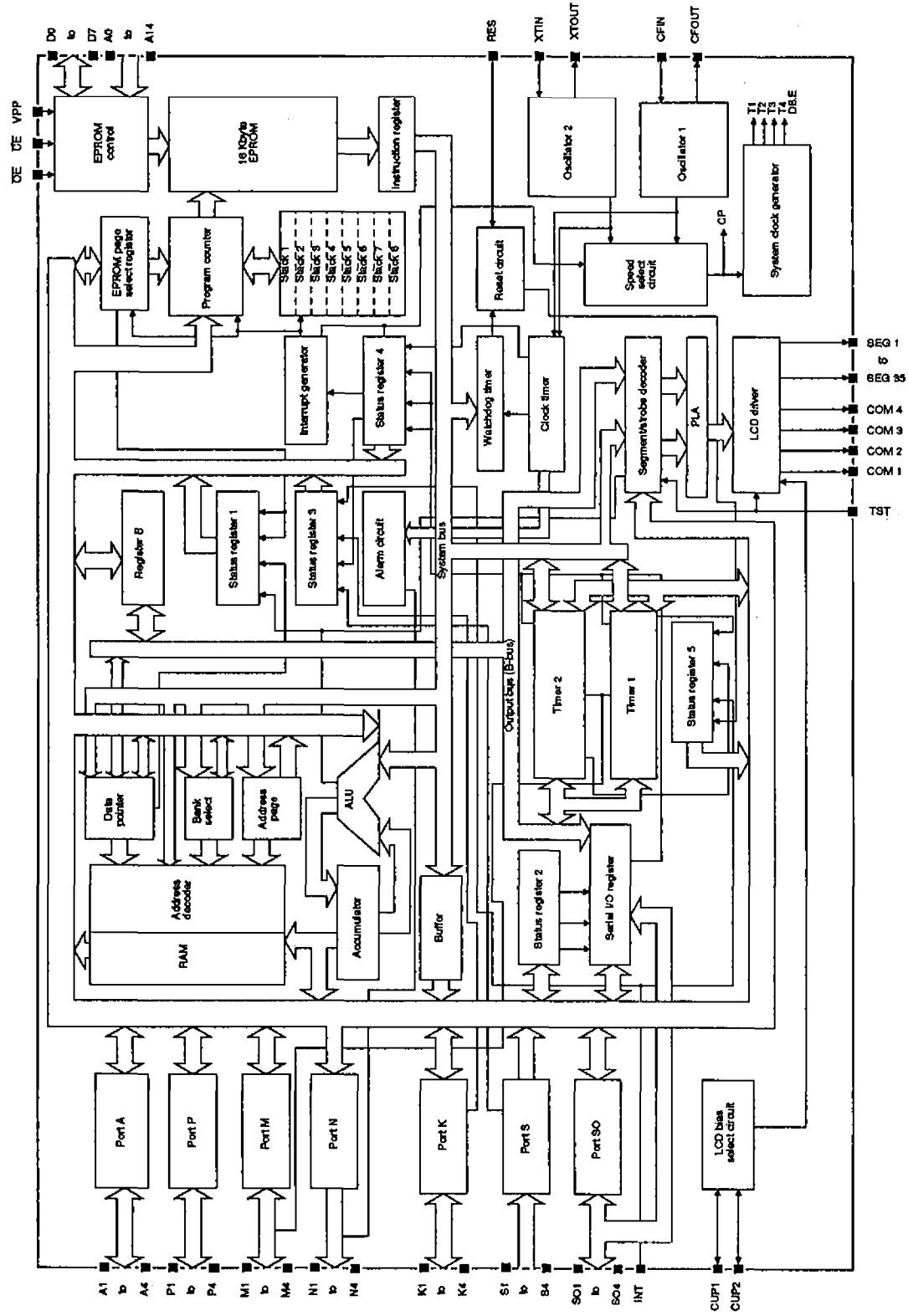

LC58E68

Pin Functions

Number	Name	Function
1	COM2	LCD common outputs
2	COM1	
3	CUP1	LCD drive bias circuit capacitor connections
4	CUP2	
5	RES	Active-HIGH reset input
6	INT/OE	Multiplexed interrupt request (INT) and EPROM output enable ( $\overline{OE}$ ) input
7	SO1/A08	Multiplexed 4-bit input/output port SO (SO1 to SO4), serial port (SO1 to SO3) and EPROM address inputs (A08 to A11)
8	SO2/A09	
9	SO3/A10	
10	SO4/A11	
11	A1/A12	Multiplexed 4-bit input/output port A (A1 to A4), EPROM address inputs (A12 to A14) and chip enable input ( $\overline{CE}$ )
12	A2/A13	
13	A3/A14	
14	A4/ $\overline{CE}$	
15	P1/D4	Multiplexed 4-bit input/output port P (P1 to P4) and EPROM data bus lines (D4 to D7)
16	P2/D5	
17	P3/D6	
18	P4/D7	
19	XTOUT	Crystal oscillator connections
20	XTIN	
21	VDD2	LCD drive bias supply capacitor connections
22	VDD1	
23	VSS	Ground
24	VDD	Voltage supply
25	CFIN	Ceramic filter oscillator connections
26	CFOUT	
27	S1/A00	Multiplexed 4-bit input port S (S1 to S4) and EPROM address inputs (A00 to A03)
28	S2/A01	
29	S3/A02	
30	S4/A03	
31	K1/D0	Multiplexed 4-bit input/output port K (K1 to K4) and EPROM data bus lines (D0 to D3)
32	K2/D1	
33	K3/D2	
34	K4/D3	

## LC58E68

Number	Name	Function
35	M1/A04	Multiplexed 4-bit input/output port M (M1 to M4), EPROM address inputs (A04 to A07) and timer 1 and 2 external clock inputs (M3 and M4)
36	M2/A05	
37	M3/A06	
38	M4/A07	
39	N1	Multiplexed 4-bit, open-drain output port N (N1 to N4) and alarm signal output (N4)
40	N2	
41	N3	
42	N4	
43	TST/VPP	Multiplexed test input (TST) and EPROM V <sub>PP</sub> supply (VPP)
44 to 78	SEG1 to SEG35	LCD segment drivers or general-purpose outputs
79	COM4	LCD common outputs
80	COM3	

### Specifications

#### Absolute Maximum Ratings

Parameter	Symbol	Ratings	Unit
Supply voltage range	V <sub>DD max</sub>	-0.3 to +6.0	V
LCD supply voltage 1 range	V <sub>DD1</sub>	-0.3 to V <sub>DD</sub>	V
LCD supply voltage 2 range	V <sub>DD2</sub>	-0.3 to V <sub>DD</sub>	V
XTIN and CFIN input voltage range	V <sub>I1</sub>	0 to maximum generated voltage	V
Ports S, K, P, SO and A, and RES, INT and TST input voltage range	V <sub>I2</sub>	-0.3 to V <sub>DD</sub> + 0.3	V
XTOUT and CFOUT output voltage range	V <sub>O1</sub>	0 to maximum generated voltage	V
Ports K, P, SO and A, and CUP1, CUP2, SEG1 to SEG 35 and COM1 to COM4 output voltage range	V <sub>O2</sub>	-0.3 to V <sub>DD</sub> + 0.3	V
Port N open-drain output voltage range	V <sub>O3</sub>	-0.3 to +13	V
Port N output current range	I <sub>O1</sub>	-10 to +15	mA
Ports K, P, M, SO and A output current range	I <sub>O2</sub>	-5 to +5	mA
Ports K, P, M, SO, A and N, and SEG1 to SEG 35 total output current range	ΣI <sub>O</sub>	-70 to 70	mA
Power dissipation	P <sub>D</sub>	500	mW
Operating temperature range	T <sub>opr</sub>	10 to 40	°C
Storage temperature range	T <sub>stg</sub>	-55 to +125	°C

LC58E68

Allowable Operating Ranges

$T_a = 25\text{ }^\circ\text{C}$

Parameter	Symbol	Ratings	Unit
Supply voltage range with LCD disabled. See note 1.	$V_{DD}$	2.8 to 5.5	V
Supply voltage range with static bias. See note 1.	$V_{DD}$	2.8 to 5.5	V
Supply voltage range with 1/2-bias. See note 2.	$V_{DD}$	2.8 to 5.5	V
Supply voltage range with 1/3-bias. See note 3.	$V_{DD}$	2.8 to 5.5	V
Minimum data retention voltage. See note 4.	$V_{DR}$	2.8 to $V_{DD}$	V

Notes

- $V_{DD1} = V_{DD2} = V_{DD}$
- $V_{DD1} = V_{DD2} \approx 1/2 \times V_{DD}$
- $V_{DD1} \approx 2/3 \times V_{DD}$ ,  $V_{DD2} \approx 1/3 \times V_{DD}$
- Oscillator and all internal circuits halted

Electrical Characteristics

$V_{DD} = 2.8\text{ to }3.2\text{ V}$

$T_a = 25\text{ }^\circ\text{C}$

Parameter	Symbol	Conditions	Ratings			Unit
			min	typ	max	
LCD supply voltage 1	$V_{DD1}$	$V_{DD} = 3\text{ V}$ , $C1 = C2 = 0.1\text{ }\mu\text{F}$ , 1/2-bias, $f_{\text{xtal}} = 32.768\text{ kHz}$ . See figure 2.	-	1.5	-	V
		$V_{DD} = 3\text{ V}$ , $C1 = C2 = 0.1\text{ }\mu\text{F}$ , 1/3-bias, $f_{\text{xtal}} = 32.768\text{ kHz}$ . See figure 3.	-	1.0	-	
LCD supply voltage 2	$V_{DD2}$	$V_{DD} = 3\text{ V}$ , $C1 = C2 = 0.1\text{ }\mu\text{F}$ , 1/3-bias, $f_{\text{xtal}} = 32.768\text{ kHz}$ . See figure 3.	-	2.0	-	V
Supply current	$I_{DD}$	$V_{DD} = 3\text{ V}$ , $f_{\text{xtal}} = 32\text{ kHz}$ , $C_g = 20\text{ pF}$ , $Z_c = 25\text{ k}\Omega$ , halt mode, 1/2-bias. See figure 4.	-	5	-	$\mu\text{A}$
		$V_{DD} = 3\text{ V}$ , $f_{\text{xtal}} = 38\text{ or }65\text{ kHz}$ , $C_g = 10\text{ pF}$ , $Z_c = 25\text{ k}\Omega$ , halt mode, 1/3-bias. See figure 4.	-	10	-	
		$V_{DD} = 3\text{ V}$ , $f_{\text{cer}} = 400\text{ kHz}$ , $C_{cg} = C_{cd} = 330\text{ pF}$ , halt mode. See figure 5.	-	150	-	

LC58E68

Parameter	Symbol	Conditions	Ratings			Unit	
			min	typ	max		
Supply current	$I_{DD}$	$V_{DD} = 3\text{ V}$ , $f_{\text{cer}} = 1\text{ MHz}$ , $C_{\text{reg}} = C_{\text{od}} = 100\text{ pF}$ , halt mode. See figure 6.	-	200	-	$\mu\text{A}$	
Supply leakage current	$I_{DD}$	$V_{DD} = 3\text{ V}$ , standby mode. See figure 1.	-	1	-	$\mu\text{A}$	
Ports S, K, P, M, SO and A, and INT LOW-level input voltage	$V_{IL1}$		0	-	$0.3V_{DD}$	V	
Ports S, K, P, M, SO and A, and INT HIGH-level input voltage	$V_{IH1}$		$0.7V_{DD}$	-	$V_{DD}$	V	
RES and CFIN LOW-level input voltage	$V_{IL2}$		0	-	$0.25V_{DD}$	V	
RES and CFIN HIGH-level input voltage	$V_{IH2}$		$0.75V_{DD}$	-	$V_{DD}$	V	
Ports K, P, M, SO and A LOW-level output voltage	$V_{OL2}$	$I_{OL} = 400\ \mu\text{A}$	-	0.2	0.5	V	
Ports K, P, M, SO and A HIGH-level output voltage	$V_{OH1}$	$I_{OH} = -400\ \mu\text{A}$	$V_{DD} - 0.5$	$V_{DD} - 0.2$	-	V	
Ports S, K, M, SO and A, and INT input leakage current	$I_{\text{leak1}}$	$V_{DD} = 3\text{ V}$	$V_i = V_{SS}$	-1	-	-	$\mu\text{A}$
			$V_i = V_{DD}$	-	-	1	
Port N LOW-level output voltage	$V_{OL1}$	$I_{OL} = 10\text{ mA}$	-	-	0.5	V	
Port N output leakage current	$I_{\text{leak2}}$	$V_{OH} = 10.5\text{ V}$	-	-	1	$\mu\text{A}$	
SEG1 to SEG35 CMOS LOW-level output voltage	$V_{OL3}$	$I_{OL} = 100\ \mu\text{A}$	-	-	0.5	V	
SEG1 to SEG35 CMOS HIGH-level output voltage	$V_{OH2}$	$I_{OH} = -100\ \mu\text{A}$	$V_{DD} - 0.5$	-	-	V	
SEG1 to SEG35 p-channel HIGH-level output voltage	$V_{OH3}$	$I_{OH} = -100\ \mu\text{A}$	$V_{DD} - 0.5$	-	-	V	
SEG1 to SEG35 p-channel output leakage current	$I_{\text{leak3}}$	$V_{OL} = 0\text{ V}$	-	-	1	$\mu\text{A}$	
SEG1 to SEG35 n-channel LOW-level output voltage	$V_{OL4}$	$I_{OL} = 100\ \mu\text{A}$	-	-	0.5	V	
SEG1 to SEG35 n-channel output leakage current	$I_{\text{leak4}}$	$V_{OH} = V_{DD}$	-	-	1	$\mu\text{A}$	
Static-bias SEG1 to SEG35 LOW-level output voltage	$V_{OL5}$	$I_{OL} = 20\ \mu\text{A}$	-	-	0.2	V	
Static-bias SEG1 to SEG35 HIGH-level output voltage	$V_{OH4}$	$I_{OH} = -20\ \mu\text{A}$	$V_{DD} - 0.2$	-	-	V	
Static-bias COM1 LOW-level output voltage	$V_{OL6}$	$I_{OL} = 100\ \mu\text{A}$	-	-	0.2	V	
Static-bias COM1 HIGH-level output voltage	$V_{OH5}$	$I_{OH} = -100\ \mu\text{A}$	$V_{DD} - 0.2$	-	-	V	
1/2-bias SEG1 to SEG35 LOW-level output voltage	$V_{OL7}$	$I_{OL} = 20\ \mu\text{A}$	-	-	0.2	V	
1/2-bias SEG1 to SEG35 HIGH-level output voltage	$V_{OH6}$	$I_{OH} = -20\ \mu\text{A}$	$V_{DD} - 0.2$	-	-	V	

LC58E68

Parameter	Symbol	Conditions	Ratings			Unit
			min	typ	max	
1/2-bias COM1 to COM4 LOW-level output voltage	$V_{OL8}$	$I_{OL} = 100 \mu A$	-	-	0.2	V
1/2-bias COM1 to COM4 MID-level output voltage	$V_{OM1}$	$I_{OL} = 100 \mu A$ or $I_{OH} = -100 \mu A$	$(V_{DD} + 2)$ - 0.2	-	$(V_{DD} + 2)$ + 0.2	V
1/2-bias COM1 to COM4 HIGH-level output voltage	$V_{OH7}$	$I_{OH} = -100 \mu A$	$V_{DD} - 0.2$	-	-	V
1/3-bias SEG1 to SEG35 LOW-level output voltage	$V_{OL9}$	$I_{OL} = 20 \mu A$	-	-	0.2	V
1/3-bias SEG1 to SEG35 MID-level output voltage	$V_{OM2}$	$I_{OL} = 20 \mu A$ or $I_{OH} = -20 \mu A$	$(V_{DD} + 3)$ - 0.2	-	$(V_{DD} + 3)$ + 0.2	V
		$I_{OL} = 20 \mu A$ or $I_{OH} = -20 \mu A$	$(2V_{DD} + 3)$ - 0.2	-	$(2V_{DD} + 3)$ + 0.2	V
1/3-bias SEG1 to SEG35 HIGH-level output voltage	$V_{OH8}$	$I_{OH} = -20 \mu A$	$V_{DD} - 0.2$	-	-	V
1/3-bias COM1 to COM4 LOW-level output voltage	$V_{OL10}$	$I_{OL} = 100 \mu A$	-	-	0.2	V
1/3-bias COM1 to COM4 MID-level output voltage	$V_{OM3}$	$I_{OL} = 100 \mu A$ or $I_{OH} = -100 \mu A$	$(V_{DD} + 3)$ - 0.2	-	$(V_{DD} + 3)$ + 0.2	V
		$I_{OL} = 100 \mu A$ or $I_{OH} = -100 \mu A$	$(2V_{DD} + 3)$ - 0.2	-	$(2V_{DD} + 3)$ + 0.2	V
1/3-bias COM1 to COM4 HIGH-level output voltage	$V_{OH9}$	$I_{OH} = -100 \mu A$	$V_{DD} - 0.2$	-	-	V
Ports S, K, P, M, SO and A LOW-level hold transistor input resistance	$R_{IL1}$	$V_I = 0.2V_{DD}$	60	300	1200	k $\Omega$
Ports S, K, P, M, SO and A HIGH-level hold transistor input resistance	$R_{IH1}$	$V_I = 0.8V_{DD}$	60	300	1200	k $\Omega$
Ports S, K, P, M, SO and A pull-up transistor input resistance	$R_{PU1}$	$V_I = V_{SS}$	30	150	500	k $\Omega$
Ports S, K, P, M, SO and A pull-down transistor input resistance	$R_{PD1}$	$V_I = V_{DD}$	30	150	500	k $\Omega$
INT LOW-level hold transistor input resistance	$R_{IL2}$	$V_I = 0.2V_{DD}$	60	300	1200	k $\Omega$
INT HIGH-level hold transistor input resistance	$R_{IH2}$	$V_I = 0.8V_{DD}$	60	300	1200	k $\Omega$
INT pull-up transistor resistance	$R_{PU2}$	$V_I = V_{SS}$	300	1500	5000	k $\Omega$
INT pull-down transistor resistance	$R_{PD2}$	$V_I = V_{DD}$	300	1500	5000	k $\Omega$
TST pull-down transistor resistance	$R_{PD3}$	$V_I = V_{DD}$	20	70	300	k $\Omega$
XTOUT oscillation compensating capacitance	$C_d$	$V_{DD} = 3 V$	-	20	-	pF
Crystal oscillator operating frequency	$f_{xtal}$	32 kHz range	32	-	33	kHz
		38 kHz range	37	-	39	
		65 kHz range	60	-	70	
Ceramic filter oscillator operating frequency	$f_{cer}$		190	-	1200	kHz
Serial interface clock frequency	$f_{ser}$	Rise/fall time $\leq 10 \mu s$	0	-	200	kHz

LC58E68

$V_{DD} = 4.5$  to  $5.5$  V

$T_a = 25$  °C

Parameter	Symbol	Conditions	Ratings			Unit
			min	typ	max	
LCD supply voltage 1	$V_{DD1}$	$V_{DD} = 5$ V, $C1 = C2 = 0.1$ $\mu$ F, $1/2$ -bias, $f_{\text{xtal}} = 32.768$ kHz. See figure 2.	-	2.5	-	V
		$V_{DD} = 5$ V, $C1 = C2 = 0.1$ $\mu$ F, $1/2$ -bias, $f_{\text{xtal}} = 32.768$ kHz. See figure 3.	-	1.67	-	
LCD supply voltage 2	$V_{DD2}$	$V_{DD} = 5$ V, $C1 = C2 = 0.1$ $\mu$ F, $1/2$ -bias, $f_{\text{xtal}} = 32.768$ kHz. See figure 3.	-	3.33	-	V
Supply current	$I_{DD}$	$V_{DD} = 5$ V, $f_{\text{xtal}} = 32$ kHz, $C_g = 20$ pF, $Z_c = 25$ k $\Omega$ , halt mode, $1/2$ -bias. See figure 4.	-	20	-	$\mu$ A
		$V_{DD} = 5$ V, $f_{\text{xtal}} = 38$ or $65$ kHz, $C_g = 10$ pF, $Z_c = 25$ k $\Omega$ , halt mode, $1/2$ -bias. See figure 4.	-	30	-	
		$V_{DD} = 5$ V, $f_{\text{cer}} = 400$ kHz, $C_{cg} = C_{od} = 330$ pF, halt mode. See figure 5.	-	400	-	
		$V_{DD} = 5$ V, $f_{\text{cer}} = 1$ MHz, $C_{cg} = C_{od} = 100$ pF, halt mode. See figure 6.	-	450	-	
		$V_{DD} = 5$ V, $f_{\text{cer}} = 2$ MHz, $C_{cg} = C_{od} = 33$ pF, halt mode. See figure 6.	-	500	-	
		$V_{DD} = 5$ V, $f_{\text{cer}} = 4$ MHz, $C_{cg} = C_{od} = 33$ pF, halt mode. See figure 6.	-	700	-	
Supply leakage current	$I_{DD}$	$V_{DD} = 5.5$ V, standby mode. See figure 1.	-	1	-	$\mu$ A
Ports S, K, P, M, SO and A, and INT. LOW-level input voltage	$V_{IL1}$		0	-	$0.3V_{DD}$	V



LC59E68

Parameter	Symbol	Conditions	Ratings			Unit	
			min	typ	max		
Ports S, K, P, M, SO and A, and INT HIGH-level input voltage	$V_{IH1}$		$0.7V_{DD}$	-	$V_{DD}$	V	
RES and CFIN LOW-level input voltage	$V_{IL2}$		0	-	$0.25V_{DD}$	V	
RES and CFIN HIGH-level input voltage	$V_{IH2}$		$0.75V_{DD}$	-	$V_{DD}$	V	
Ports K, P, M, SO and A LOW-level output voltage	$V_{OL2}$	$I_{OL} = 2 \text{ mA}$	-	0.2	0.5	V	
Ports K, P, M, SO and A HIGH-level output voltage	$V_{OH1}$	$I_{OH} = -1 \text{ mA}$	$V_{DD} - 0.5$	$V_{DD} - 0.2$	-	V	
Ports S, K, M, SO and A, and INT input leakage current	$I_{leak1}$	$V_{DD} = 5.5 \text{ V}$	$V_I = V_{SS}$	-1	-	-	$\mu\text{A}$
			$V_I = V_{DD}$	-	-	1	
Port N LOW-level output voltage	$V_{OL1}$	$I_{OL} = 10 \text{ mA}$	-	-	0.5	V	
Port N output leakage current	$I_{leak2}$	$V_{OH} = 10.5 \text{ V}$	-	-	1	$\mu\text{A}$	
SEG1 to SEG35 CMOS LOW-level output voltage	$V_{OL3}$	$I_{OL} = 250 \mu\text{A}$	-	-	0.5	V	
SEG1 to SEG35 CMOS HIGH-level output voltage	$V_{OH2}$	$I_{OH} = -250 \mu\text{A}$	$V_{DD} - 0.5$	-	-	V	
SEG1 to SEG35 p-channel HIGH-level output voltage	$V_{OH3}$	$I_{OH} = -250 \mu\text{A}$	$V_{DD} - 0.5$	-	-	V	
SEG1 to SEG35 p-channel output leakage current	$I_{leak3}$	$V_{OL} = 0 \text{ V}$	-	-	1	$\mu\text{A}$	
SEG1 to SEG35 n-channel LOW-level output voltage	$V_{OL4}$	$I_{OL} = 250 \mu\text{A}$	-	-	0.5	V	
SEG1 to SEG35 n-channel output leakage current	$I_{leak4}$	$V_{OH} = V_{DD}$	-	-	1	$\mu\text{A}$	
Static-bias SEG1 to SEG35 LOW-level output voltage	$V_{OL5}$	$I_{OL} = 20 \mu\text{A}$	-	-	0.2	V	
Static-bias SEG1 to SEG35 HIGH-level output voltage	$V_{OH4}$	$I_{OH} = -20 \mu\text{A}$	$V_{DD} - 0.2$	-	-	V	
Static-bias COM1 LOW-level output voltage	$V_{OL6}$	$I_{OL} = 200 \mu\text{A}$	-	-	0.2	V	
Static-bias COM1 HIGH-level output voltage	$V_{OH5}$	$I_{OH} = -200 \mu\text{A}$	$V_{DD} - 0.2$	-	-	V	
1/2-bias SEG1 to SEG35 LOW-level output voltage	$V_{OL7}$	$I_{OL} = 20 \mu\text{A}$	-	-	0.2	V	
1/2-bias SEG1 to SEG35 HIGH-level output voltage	$V_{OH6}$	$I_{OH} = -20 \mu\text{A}$	$V_{DD} - 0.2$	-	-	V	
1/2-bias COM1 to COM4 LOW-level output voltage	$V_{OL8}$	$I_{OL} = 200 \mu\text{A}$	-	-	0.2	V	
1/2-bias COM1 to COM4 MID-level output voltage	$V_{OM1}$	$I_{OL} = 200 \mu\text{A}$ or $I_{OH} = -200 \mu\text{A}$	$(V_{DD} + 2) - 0.2$	-	$(V_{DD} + 2) + 0.2$	V	
1/2-bias COM1 to COM4 HIGH-level output voltage	$V_{OH7}$	$I_{OH} = -200 \mu\text{A}$	$V_{DD} - 0.2$	-	-	V	

LC58E68

Parameter	Symbol	Conditions	Ratings			Unit
			min	typ	max	
1/3-bias SEG1 to SEG35 LOW-level output voltage	$V_{OL9}$	$I_{OL} = 20 \mu A$	-	-	0.2	V
1/3-bias SEG1 to SEG35 MID-level output voltage	$V_{OM2}$	$I_{OL} = 20 \mu A$ or $I_{OH} = -20 \mu A$	$(V_{DD} + 3) - 0.2$	-	$(V_{DD} + 3) + 0.2$	V
		$I_{OL} = 20 \mu A$ or $I_{OH} = -20 \mu A$	$(2V_{DD} + 3) - 0.2$	-	$(2V_{DD} + 3) + 0.2$	V
1/3-bias SEG1 to SEG35 HIGH-level output voltage	$V_{OH8}$	$I_{OH} = -20 \mu A$	$V_{DD} - 0.2$	-	-	V
1/3-bias COM1 to COM4 LOW-level output voltage	$V_{OL10}$	$I_{OL} = 200 \mu A$	-	-	0.2	V
1/3-bias COM1 to COM4 MID-level output voltage	$V_{OM3}$	$I_{OL} = 200 \mu A$ or $I_{OH} = -200 \mu A$	$(V_{DD} + 3) - 0.2$	-	$(V_{DD} + 3) + 0.2$	V
		$I_{OL} = 200 \mu A$ or $I_{OH} = -200 \mu A$	$(2V_{DD} + 3) - 0.2$	-	$(2V_{DD} + 3) + 0.2$	V
1/3-bias COM1 to COM4 HIGH-level output voltage	$V_{OH9}$	$I_{OH} = -200 \mu A$	$V_{DD} - 0.2$	-	-	V
Ports S, K, P, M, SO and A LOW-level hold transistor input resistance	$R_{IL1}$	$V_I = 0.2V_{DD}$	30	120	500	k $\Omega$
Ports S, K, P, M, SO and A HIGH-level hold transistor input resistance	$R_{IH1}$	$V_I = 0.8V_{DD}$	30	120	500	k $\Omega$
Ports S, K, P, M, SO and A pull-up transistor input resistance	$R_{PU1}$	$V_I = V_{SS}$	10	50	200	k $\Omega$
Ports S, K, P, M, SO and A pull-down transistor input resistance	$R_{PD1}$	$V_I = V_{DD}$	10	50	200	k $\Omega$
INT LOW-level hold transistor input resistance	$R_{IL2}$	$V_I = 0.2V_{DD}$	30	120	500	k $\Omega$
INT HIGH-level hold transistor input resistance	$R_{IH2}$	$V_I = 0.8V_{DD}$	30	120	500	k $\Omega$
INT pull-up transistor resistance	$R_{PU2}$	$V_I = V_{SS}$	100	500	2000	k $\Omega$
INT pull-down transistor resistance	$R_{PD2}$	$V_I = V_{DD}$	100	500	2000	k $\Omega$
TST pull-down transistor resistance	$R_{PD3}$	$V_I = V_{DD}$	20	70	300	k $\Omega$
XTOUT oscillation compensating capacitance	$C_d$	$V_{DD} = 5 V$	-	20	-	pF
Crystal oscillator operating frequency	$f_{xtal}$	32 kHz range	32	-	33	kHz
		38 kHz range	37	-	39	
		65 kHz range	60	-	70	
Ceramic filter oscillator operating frequency	$f_{cer}$		190	-	1200	kHz
Serial interface clock frequency	$f_{ser}$	Rise/fall time $\leq 10 \mu s$	0	-	200	kHz

**Measurement Circuits**

The following conditions apply to figure 1.

- Standby mode
- Port S input resistors enabled
- I/O ports in output mode, all outputs HIGH
- INT open and internal input transistors enabled
- External pull-down resistor connected to RES.
- Current flow through components connected to LCD ports is not included.
- $f_{xtal} = 32$  to 65 kHz
- $f_{cer} = 200$  kHz to 4 MHz

The following conditions apply to figures 2 and 3.

- $f_{xtal} = 32$  kHz
- $C1 = C2 = C3 = 0.1 \mu F$
- LCD ports are open.
- $f_{cer} = 200$  kHz to 4 MHz

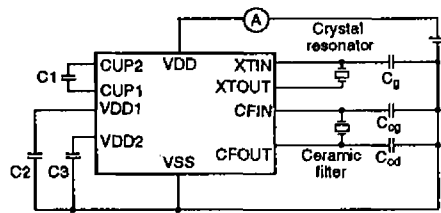

Figure 1. Supply leakage measurement

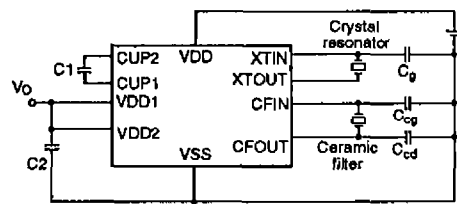

Figure 2. Output voltage measurement 1

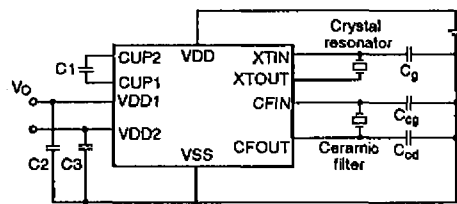

Figure 3. Output voltage measurement 2

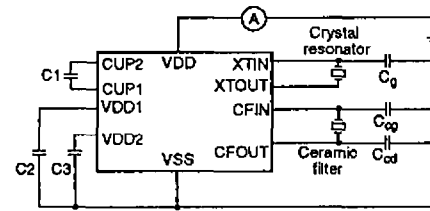

Figure 4. Supply current measurement 1

**Notes**

1. Ceramic filter oscillator stopped
2.  $f_{xtal} = 32, 38$  or 65 kHz

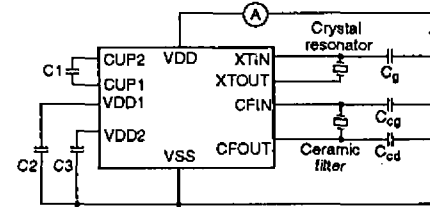

Figure 5. Supply current measurement 2

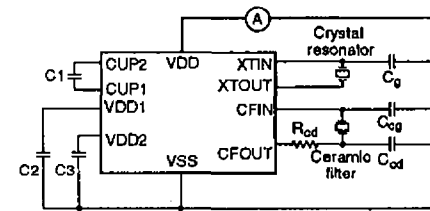

Figure 6. Supply current measurement 3

**Note**

Crystal oscillator stopped

LC58E68

Pin Functions

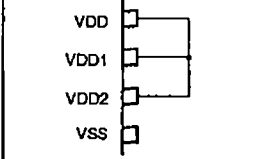
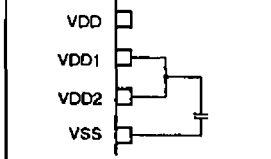
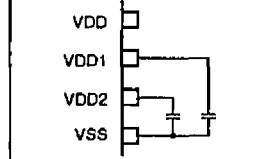
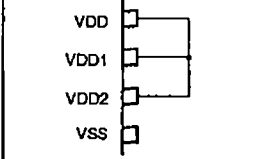
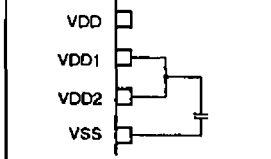
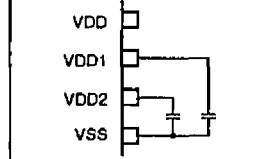
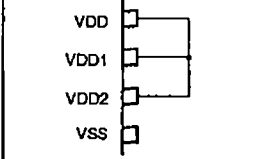
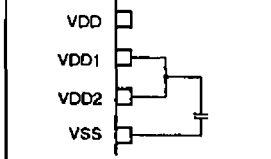
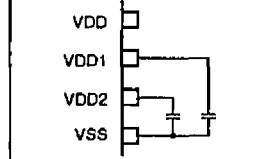
Name	Function																														
COM1	<p>COM1 to COM4 function as LCD common driver outputs. The active outputs and frame frequency for each duty cycle are shown in the table below.</p> <table border="1"> <thead> <tr> <th>Duty cycle</th> <th>COM1</th> <th>COM2</th> <th>COM3</th> <th>COM4</th> <th>Frame frequency (Hz)</th> </tr> </thead> <tbody> <tr> <td>Static</td> <td>✓</td> <td>-</td> <td>-</td> <td>-</td> <td>32</td> </tr> <tr> <td>1/2</td> <td>✓</td> <td>✓</td> <td>-</td> <td>-</td> <td>32</td> </tr> <tr> <td>1/3</td> <td>✓</td> <td>✓</td> <td>✓</td> <td>-</td> <td>42.7</td> </tr> <tr> <td>1/4</td> <td>✓</td> <td>✓</td> <td>✓</td> <td>✓</td> <td>32</td> </tr> </tbody> </table>	Duty cycle	COM1	COM2	COM3	COM4	Frame frequency (Hz)	Static	✓	-	-	-	32	1/2	✓	✓	-	-	32	1/3	✓	✓	✓	-	42.7	1/4	✓	✓	✓	✓	32
Duty cycle		COM1	COM2	COM3	COM4	Frame frequency (Hz)																									
Static		✓	-	-	-	32																									
1/2		✓	✓	-	-	32																									
1/3		✓	✓	✓	-	42.7																									
1/4	✓	✓	✓	✓	32																										
COM2																															
COM3																															
COM4																															
	<p><b>Note</b>  <math>\phi_0 = 32.768 \text{ kHz}</math></p>																														
CUP1	<p>CUP1 and CUP2 are part of the LCD-drive voltage divider circuit. When using 1/2- or 1/3-bias, connect a bipolar capacitor between these pins, otherwise leave them open.</p>																														
CUP2																															
RES	<p>RES pulsewidths greater than 200 <math>\mu\text{s}</math> reset the microprocessor. RES requires an external input resistor.</p>																														
INT/OE	<p>INT functions as the output enable input when the EPROM is addressed.</p>																														
SO1/A08	<p>Port SO functions as address bus inputs when the EPROM is addressed. SO1 also functions as the serial data input, SO2 as the serial data output and SO3 as the serial data clock input or output. Clock direction and polarity are determined by software.</p>																														
SO2/A09																															
SO3/A10																															
SO4/A11																															
A1/A12	<p>Port A functions as address bus inputs and the chip enable input when the EPROM is addressed.</p>																														
A2/A13																															
A3/A14																															
A4/CE																															
P1/D4	<p>Port P functions as data bus lines when the EPROM is addressed.</p>																														
P2/D5																															
P3/D6																															
P4/D7																															
XTIN	<p>XTIN and XTOUT function as the crystal oscillator connections, otherwise they are left open. The crystal frequency is a configuration option. The oscillator halts after a HOLD instruction.</p>																														
XTOUT																															
VDD1	<p>VDD1 and VDD2 function as LCD drive bias circuit capacitor connections. For each bias drive, connect these pins as shown below.</p> <table border="1"> <thead> <tr> <th>Static bias</th> <th>1/2-bias</th> <th>1/3-bias</th> </tr> </thead> <tbody> <tr> <td>  </td> <td>  </td> <td>  </td> </tr> </tbody> </table>	Static bias	1/2-bias	1/3-bias																											
Static bias		1/2-bias	1/3-bias																												
																															
VDD2																															
CFIN	<p>CFIN and CFOUT function as the ceramic filter connections, otherwise they are left open. The oscillator halts after a HOLD or SLOW instruction.</p>																														
CFOUT																															

## LC58E68

Name	Function
S1/A00	Port S functions as address bus inputs when the EPROM is addressed. Port S pins have internal key-debounce circuits. The 1.95 or 7.8 ms (at $\phi_0 = 32.768$ kHz) debounce delay period is selected by software.
S2/A01	
S3/A02	
S4/A03	
K1/D0	Port K functions as data bus lines when the EPROM is addressed. Port K pins have internal input key-debounce circuits. The delay period is the same as the port S debounce delay.
K2/D1	
K3/D2	
K4/D3	
M1/A04	Port M functions as address bus inputs when the EPROM is addressed. M3 also functions as timer 1, and M4 as timer 2 external clock inputs when the timers are in mode 3. The minimum external clock period is double the cycle time.
M2/A05	
M3/A06	
M4/A07	
N1	N4 functions as the 1, 2, or 4 kHz (at $\phi_0 = 32.768$ kHz) alarm signal output (when the N4 output latch is LOW).
N2	
N3	
N4	
TST/VPP	TST functions as the VPP input when the EPROM is addressed. It is normally connected to ground.
SEG1 to SEG35	SEG1 to SEG35 function as LCD segment drivers or general-purpose outputs. The function of individual outputs are set as configuration options.

### Configuration Options

#### Oscillator

The oscillator options are ceramic filter, crystal, and both ceramic filter and crystal. When the crystal oscillator is used, the oscillator frequency options are 32, 38 or 65 kHz. The ceramic filter and crystal oscillator options are shown in figures 7 and 8, respectively.

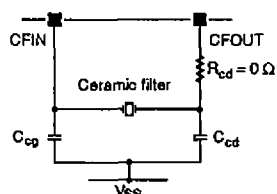

Figure 7. Ceramic filter oscillator

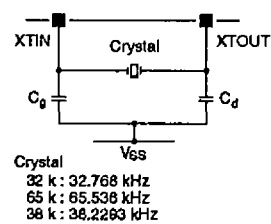

Figure 8. Crystal oscillator

**Input Ports**

Ports S, K, P, SO and A input options are hold transistor and input transistor configurations as shown in figure 9. The hold transistor options are LOW-level hold transistor, HIGH-level hold transistor and no hold transistor enabled. The input options are pull-up and pull-down transistors enabled.

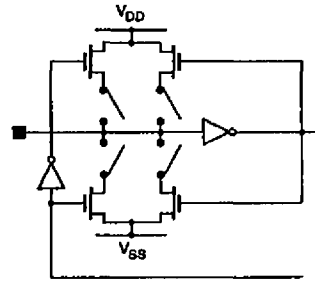

Figure 9. Ports S, K, P, SO and A input circuit

**Note**

Configuration data determines switch settings.

**Outputs**

**SEG1 to SEG35**

The SEG1 to SEG35 options are LCD driver or general-purpose outputs, LCD driver bias and duty configuration, general-purpose output configuration and output latch state in STOP mode. The LCD driver and general-purpose output function selection is hard coded in the PLA and, therefore, cannot be selected by software.

The LCD driver bias and duty configuration is set for all LCD drivers. The configuration options are as follows.

- Static
- 1/2-bias and 1/2-duty
- 1/2-bias and 1/3-duty
- 1/2-bias and 1/4-duty
- 1/3-bias and 1/3-duty
- 1/3-bias and 1/4-duty

The general-purpose output configuration is set for individual outputs. The options are CMOS, p-channel open-drain and n-channel open-drain. The p-channel and n-channel output equivalent circuits are shown in figures 10 and 11, respectively.

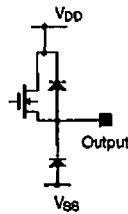

Figure 10. p-channel output

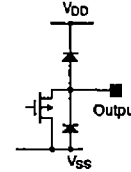

Figure 11. n-channel output

The output latch state of all LCD drivers and general-purpose outputs can be reset in standby mode. The options are reset and no change.

**Port N**

Port N outputs are n-channel open-drain as shown in figure 12.

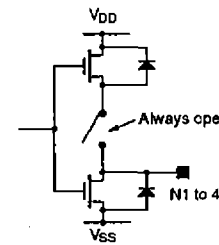

Figure 12. Port N open-drain outputs

**Serial Data Clock**

The SO3 clock divider ratio options are 1/1, 1/2 and 1/4.

**Interrupt Request**

The interrupt request input options are hold transistor, input transistor and interrupt request trigger configurations. The input hold transistor and input transistor options are the same as for the port inputs. The interrupt request trigger options are rising-edge and falling-edge triggering.

**Design Information**

**Development Process**

The LC5860 series software development tools, EC5868.EXE software and a general-purpose PROM programmer with a W58E68Q adapter board are

required for LC58E68 program development. The development flowchart is shown in figure 13.

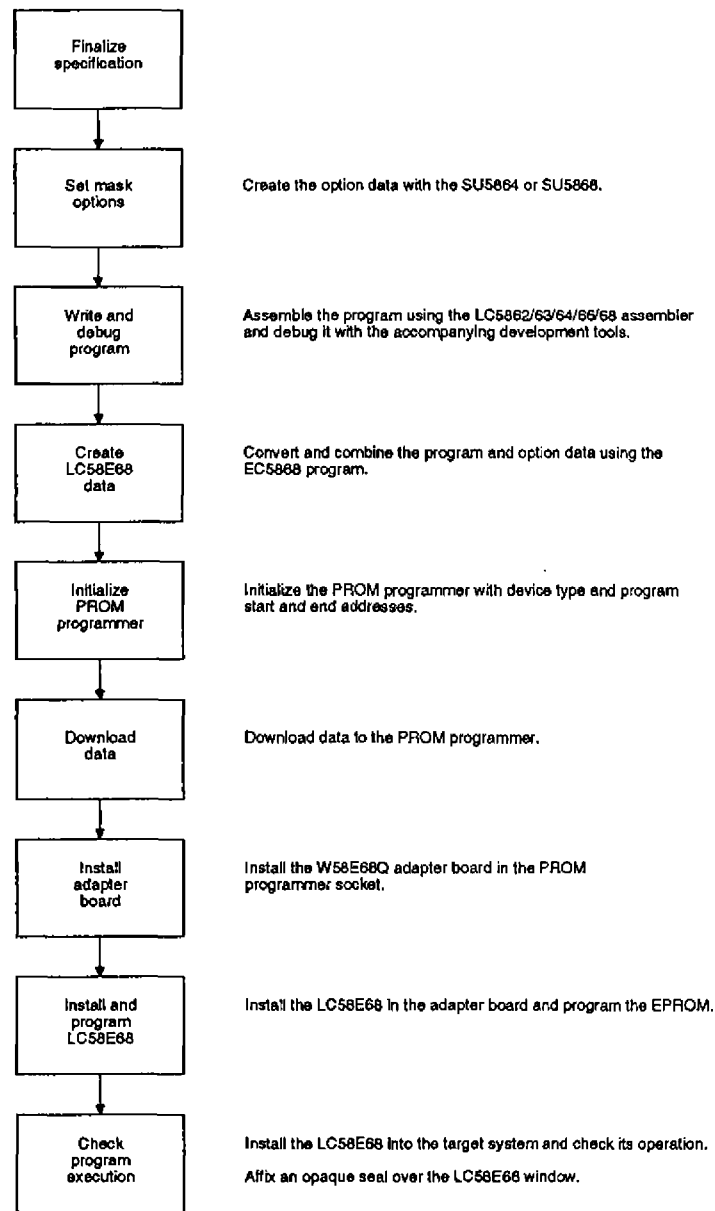

Figure 13. Development flowchart

LC58E68

**LC586X series software development tools**

These tools are used on an MS-DOS computer to create programs and option data. See the LC586X series development tools manual for further information.

**EC5868.EXE**

This program combines an LC586X series program with the configuration option data generated by the option

data software and converts the result to LC58E68 EPROM downloading format as shown in figure 14.

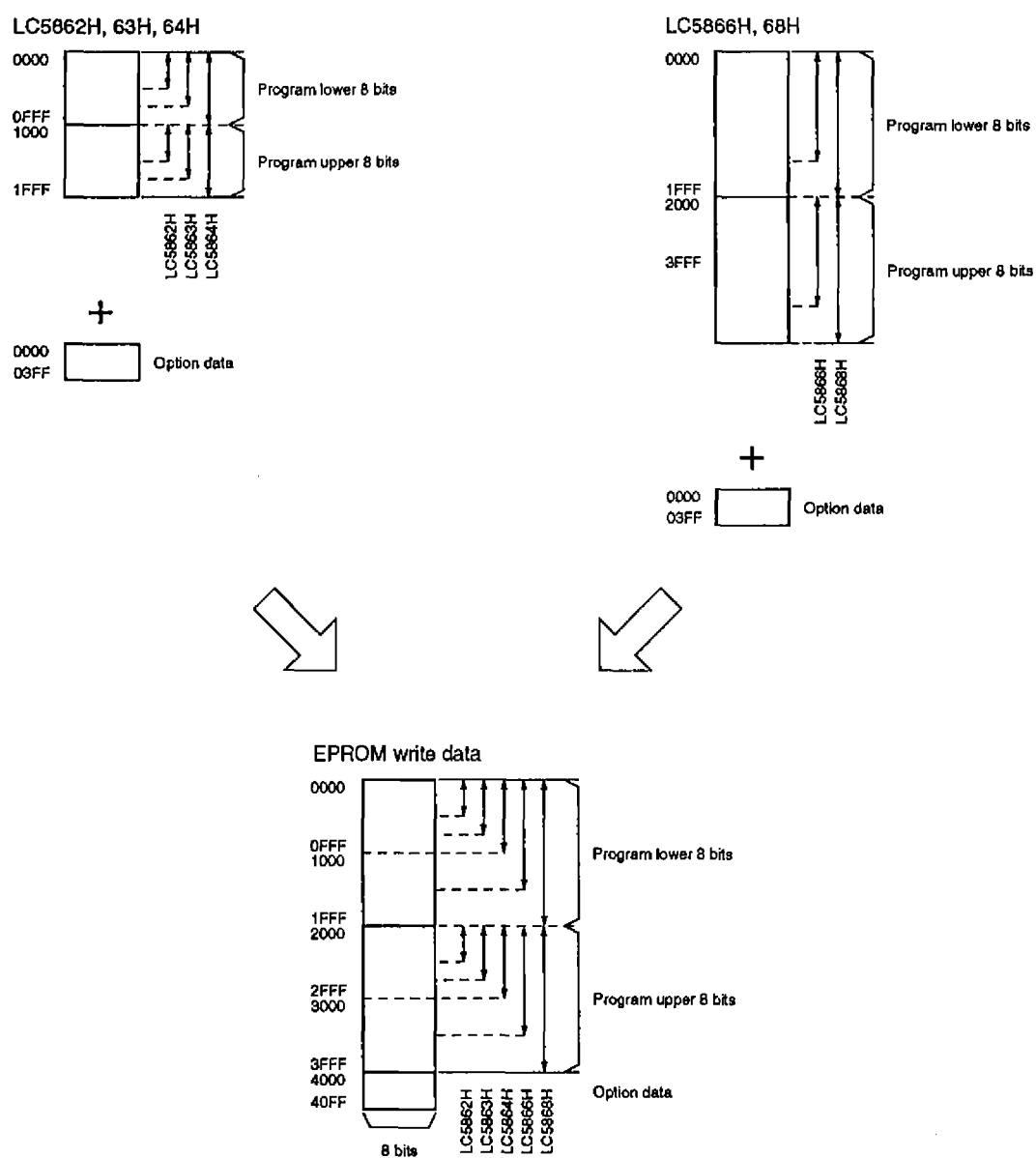

Figure 14. Conversion to EPROM format



## LC58E68

For example, to convert the ROMSAMP.HEX program file and the PLASAMP.HEX option data file into the

EP-SAMP.HEX download-format file, enter one of the following commands at the command line:

```
A:> EC5868 ROMSAMP.HEX PLASAMP.HEX EP-SAMP.HEX ↵
or
A:> EC5868 B:ROMSAMP.HEX B:PLASAMP.HEX C:EP-SAMP.HEX ↵
or
A:> EC5868 ↵
*****
* LC58E68 PROGRAM & MASK OPTION CONVERSION Ver XXXX *
*****
A: ROM PROGRAM NAME : B:ROMSAMP.HEX ↵
A: PLA PROGRAM NAME : B:PLASAMP.HEX ↵
A: EP ROM WRITE NAME : B:EP-SAMP.HEX ↵
```

A program completion message is output at the end of conversion.

If an error occurs, the program will issue one of the following error messages.

- Error ON filename.HEX, FILE NOT FOUND  
The file filename.HEX was not found or the file name was incorrect.
- Error ON, MAKE LC5864H, 63H, 62H  
The ROM data and option data are not consistent. The cross assembler and option data software used should be for the same device.
- Error ON filename.HEX, EOF NOT DETECTED  
The file filename.HEX does not have a record end marker or the file is corrupted.
- Error ON filename.HEX, ILLEGAL CHARACTER  
The file filename.HEX contains a non-hexadecimal character.
- Error ON filename.HEX, ADDRESS OVER  
An address in the file filename.HEX exceeds the address limit.
- Error ON filename.HEX, ILLEGAL FILE HDR.  
The file filename.HEX does not have the correct LC586X series header or there is an error in the hex file.
- Error ON command line input, INVALID NUMBER OF PARAMETERS  
The number of parameters entered on the command line is incorrect.
- Error ON ILLEGAL, MASK OPTION DATA  
The mask option data is incorrect.

### PROM programmer and W58E68Q adapter board

Programming the LC58E68 requires a general-purpose PROM programmer and a W58E68Q adapter board.

Note that the programmer provided with the EVA-520 and EVA-850 development tools cannot be used. Set the programmer for a 256 Kbyte PROM,  $V_{pp} = 21$  V and program addresses 0000H to 40FFH.

The W58E68Q adapter board, shown in figure 15, is placed in the PROM programmer socket and the LC58E68 to be programmed, in the W58E68Q adapter.

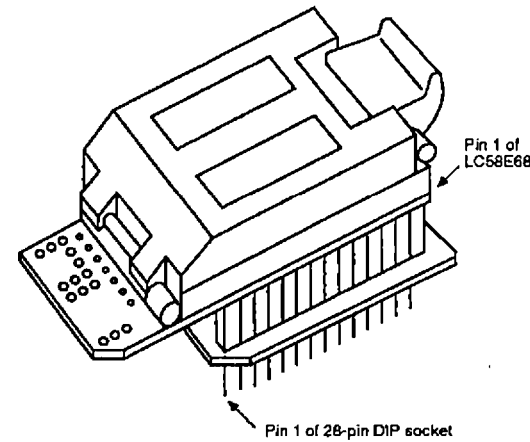

Figure 15. W58E68Q adapter board

Affix an opaque seal to the window of the programmed LC58E68 when not programming the EPROM.

### Erasing the EPROM

The EPROM data can be erased with a standard UV EPROM eraser.

### Soldering

Do not use the solder-dip process for soldering the LC58E68.

## LC58E68

### Reset Timing

The reset state is released following a HIGH-to-LOW transition on RES. Configuration options and the segment output control PLA are initialized during the next 256 clock cycles. The program counter is then reset and

program execution begins. Configuration options are invalid and segment outputs are held at  $V_{SS}$  from when RES goes HIGH until the options are initialized.

### Ordering Information

Typically, a mask ROM LC586X series device is ordered after a system has been prototyped with the LC58E68. However, a programmed LC58E68 or an LC58E68-format hex file cannot be used to specify the mask ROM device.

assembler and another three EPROMs each containing the option data generated using the option specification tool.

A comparison of LC58E68 characteristics with those of LC586X series mask ROM devices is shown in tables 1 and 2.

When ordering, provide three EPROMs each containing the mask ROM program generated using a standard

Table 1. Electrical characteristics comparison

Parameter	Symbol	Conditions	LC58E68	LC586X series	Unit
Operating temperature range	$T_{opr}$		10 to 40	-30 to 70	°C
Supply voltage range	$V_{DD}$		2.8 to 5.5	2.0 to 6.0	V
Typical halt-mode supply current	$I_{DD}$	$V_{DD} = 3\text{ V}, f_{xtal} = 32\text{ kHz}$	5	4	$\mu\text{A}$
		$V_{DD} = 5\text{ V}, f_{xtal} = 32\text{ kHz}$	20	15	
		$V_{DD} = 5\text{ V}, f_{cer} = 400\text{ kHz}$	400	400	
		$V_{DD} = 5\text{ V}, f_{cer} = 2\text{ MHz}$	500	500	
		$V_{DD} = 5\text{ V}, f_{cer} = 4\text{ MHz}$	700	700	

Table 2. Configuration comparison

Parameter	LC58E68	LC586X devices
LCD segment and common outputs during reset	Segment outputs are CMOS and are held at $V_{SS}$ . Common outputs are n-channel and open-drain.	Static operation
Segment output state after reset	Not displayed	Displayed or not displayed
Oscillator circuit type	Ceramic filter, crystal, or ceramic filter and crystal	Ceramic filter, crystal, ceramic filter and crystal, RC circuit, RC circuit and crystal, external oscillator or external oscillator and crystal
Crystal frequency	32, 38 or 65 kHz (65 kHz during reset)	32, 38 or 65 kHz
RES reset input	Active-HIGH	Active-LOW, active-LOW with pull-up, active-HIGH or active-HIGH with pull-up
Port N outputs	Open-drain	Open-drain or CMOS
LCD drive type	Static, $1/2$ -bias and $1/2$ -duty, $1/2$ -bias and $1/3$ -duty, $1/2$ -bias and $1/4$ -duty, $1/3$ -bias and $1/3$ -duty or $1/3$ -bias and $1/4$ -duty (See note 1.)	Static, $1/2$ -bias and $1/2$ -duty, $1/2$ -bias and $1/3$ -duty, $1/2$ -bias and $1/4$ -duty, $1/3$ -bias and $1/3$ -duty, $1/3$ -bias and $1/4$ -duty or unused
'Strobe No.' range	00H to 1EH (See note 2.)	00H to 1EH

### Notes

1. Configure as static drive if not used.
2. Strobe numbers 00 to 1EH can be used in applications that use a 2 MHz ceramic resonator. Strobe numbers 0E, 0F and 1EH cannot be used in applications that use a 4 MHz ceramic resonator.

## LC58E68

The LC586X series devices, including the LC58E68, are shown in table 3.

Table 3. LC586X series devices

Device	ROM capacity (Kbytes)	RAM capacity (bits)	Package type
LC5862H	4	256 × 4	QIP80
LC5863H	6	256 × 4	QIP80
LC5864H	8	256 × 4	QIP80
LC5866H	12	256 × 4	QIP80
LC5868H	16	256 × 4	QIP80
LC58E68	16 (EPROM)	256 × 4	QFC80

Table 4. Recommended ceramic resonators for LC5862H/63H/64H/66H/68H mask ROMs

Resonator frequency	Manufacturer					
	Murata			Kyocera		
	Part number	C <sub>cg</sub> (pF)	C <sub>cd</sub> (pF)	Part number	C <sub>cg</sub> (pF)	C <sub>cd</sub> (pF)
400 kHz	CSB400P	330	330	KBR-400B	330	330
800 kHz	CSB800J	220	220	KBR-800H	100	100
1 MHz	CSB1000J	220	220	KBR-1000H	100	100
2 MHz	CSA2.00MG CST2.00MG	33	33	KBR-2.0MS	33	33
4 MHz	CSA4.00MG CST4.00MG	33	33	KBR-4.0MS	33	33

- No products described or contained herein are intended for use in surgical implants, life-support systems, aerospace equipment, nuclear power control systems, vehicles, disaster/crime-prevention equipment and the like, the failure of which may directly or indirectly cause injury, death or property loss.
- Anyone purchasing any products described or contained herein for an above-mentioned use shall:
  - ① Accept full responsibility and indemnify and defend SANYO ELECTRIC CO., LTD., its affiliates, subsidiaries and distributors and all their officers and employees, jointly and severally, against any and all claims and litigation and all damages, cost and expenses associated with such use;
  - ② Not impose any responsibility for any fault or negligence which may be cited in any such claim or litigation on SANYO ELECTRIC CO., LTD., its affiliates, subsidiaries and distributors or any of their officers and employees jointly or severally.
- Information (including circuit diagrams and circuit parameters) herein is for example only; it is not guaranteed for volume production. SANYO believes information herein is accurate and reliable, but no guarantees are made or implied regarding its use or any infringements of intellectual property rights or other rights of third parties.