

Gray scale processor (64 tones)

BU2135K

The BU2135K is an LSI designed for use in image scanners and facsimile machines, with a function which takes analog image signals output from an image sensor in an image processing device and converts them to binary format.

This product is equipped with an internal 8-bit A/D converter, image sensor control circuit, and CPU interface, and can be configured easily for data reading. It is compatible with the BU2134AK, making it easy to configure up 64-tone settings.

●Applications

Facsimile machines, word processors, and other similar devices

●Features

- | | |
|---|--|
| 1) Internal 8-bit A/D converter. (internal data width after shading : 6 bits) | 4) Applied binary processing. |
| 2) Internal 8-bit D/A converter. | 5) Data can be read following shading correction. |
| 3) Isolated point rejection. (when using simple binary processing) | All other functions of the BU2134AK are included in the BU2135K. |

●Block diagram

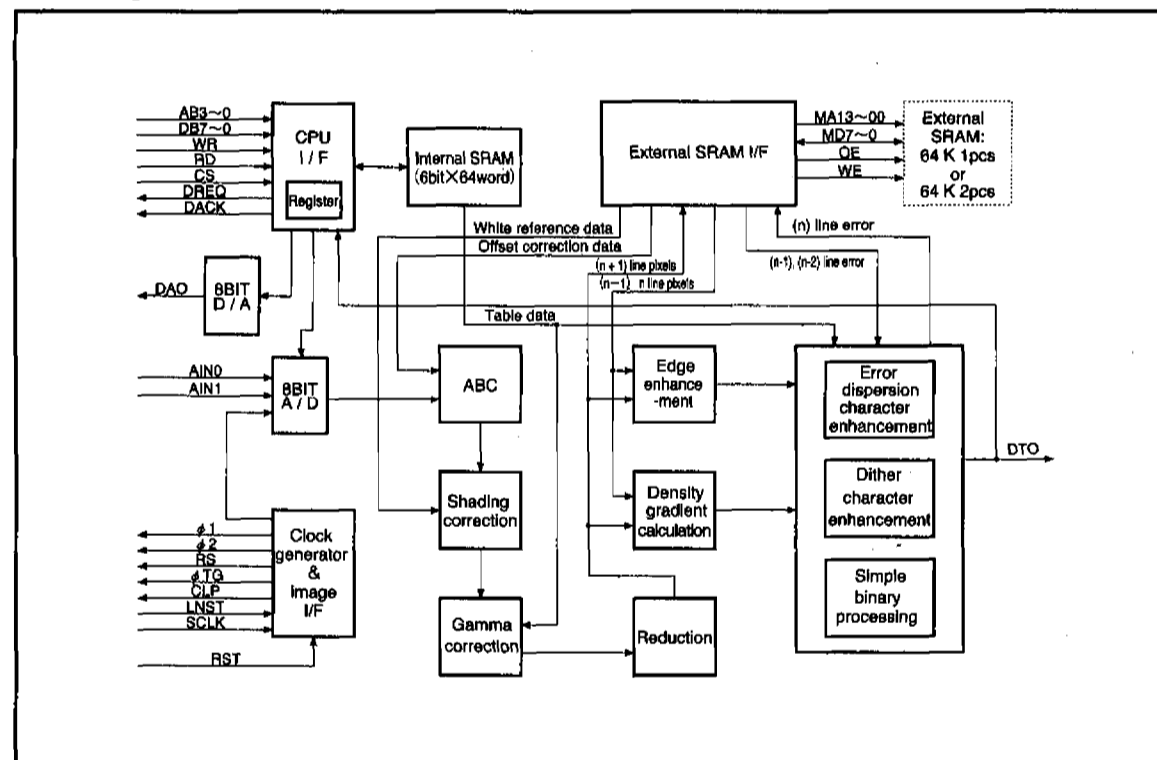

● Absolute maximum ratings (Unless otherwise noted, $T_a=25^\circ\text{C}$, $V_{DD}=5\text{V}$)

Parameter	Symbol	Limits	Unit
Power supply voltage	V_{DD}	$-0.3\sim 7.0$	V
Input voltage	V_{IN}	$-0.3\sim V_{DD}+0.3$	V
Analog power supply voltage	AV_{DD}	$-0.3\sim V_{DD}+0.3$	V
Analog input voltage	AV_{IN}	$-0.3\sim AV_{DD}+0.3$	V
Operating temperature	T_{opr}	$0\sim 70$	$^\circ\text{C}$
Storage temperature	T_{stg}	$-55\sim 150$	$^\circ\text{C}$
Input current	I_{IN}	± 20	mA
Output current	I_O	± 20	mA
Power dissipation	P_d	800*	mW

* Reduced by 8.0mW for each increase in T_a of 1°C over 25°C .

● Recommended operating conditions (Unless otherwise noted, $T_a=25^\circ\text{C}$, $V_{DD}=5\text{V}$)

Parameter	Symbol	Min.	Typ.	Max.	Unit
Power supply voltage	V_{DD}	4.75	5	5.25	V
Input voltage	V_{IN}	0	—	V_{DD}	V
Analog power supply voltage	AV_{DD}	0	—	V_{DD}	V
Analog ground voltage	A_{GND}	—	0	—	V
Reference voltage +	$REF+$	3	—	AV_{DD}	V
Reference voltage -	$REF-$	0	—	1	V
Analog input voltage	A_{IN}	$REF-$	—	$REF+$	V

FAX Image processing ASSP for FAX

● Pin descriptions

Parameter	Pin Name	I/O	Function
Video signal output	DTO	Output	Outputs binary video signal as serial data.
Line memory interface	MA13~MA00	Output	Outputs external SRAM address; MA13 is MSB.
	MD7~MD0	Input/Output	Data bus for external SRAM; MD7 is MSB.
	\overline{OE}	Output	Output Enable signal for external SRAM (negative logic)
	\overline{WE}	Output	Write Enable signal for external SRAM (negative logic)
CPU interface	AB3~AB0	Input	Address input pin; AB4 is MSB.
	DB7~DB0	Input/Output	Data input/output pin; DB7 is MSB.
	\overline{WF}	Input	Write input pin for setting internal register (negative logic)
	\overline{RD}	Input	Read input pin for reading internal register (negative logic)
	DREQ	Output	Outputs DMA Request signal in parallel mode. Outputs DTO latch clock in serial mode.
	\overline{DACK}	Input/Output	Inputs DMA Acknowledge signal in parallel mode (negative logic). Outputs DTO Enable signal in serial mode (negative logic).
	\overline{CS}	Input	Chip Select input pin which enables access to internal register (negative logic)
	\overline{RST}	Input	System reset input pin (negative logic)
System clock	SCLK	Input	System clock input pin
Line start	\overline{LNST}	Input	Inputs line start signal
Image sensor interface	$\phi 1$	Output	Output pin 1 for image sensor drive clock
	$\phi 2$	Output	Output pin 2 for image sensor drive clock
	RS	Output	Image sensor reset signal output pin
	ϕTG	Output	Image sensor transfer gate pulse output pin
	CLP	Output	Analog ground signal
Analog interface	DAO	Output	Outputs conversion voltage for D/A converter.
	AIN0	Input	Inputs image sensor analog video signals.
	AIN1	Input	Inputs analog signals (such as temperature sensor).
	REF+		Connect this to reference voltage of the A/D converter full-scale point.
	REF-		Connect this to reference voltage of the A/D converter zero point.
Power supply/ground	V _{DD}		Connect this to the digital power supply (+5 V) (Pin 3).
	GND		Connect this to the digital ground (Pin 4).
	AV _{DD}		Connect this to the analog power supply (Pin 1).
	AGND		Connect this to the analog ground (Pin 1).

● Pin assignments

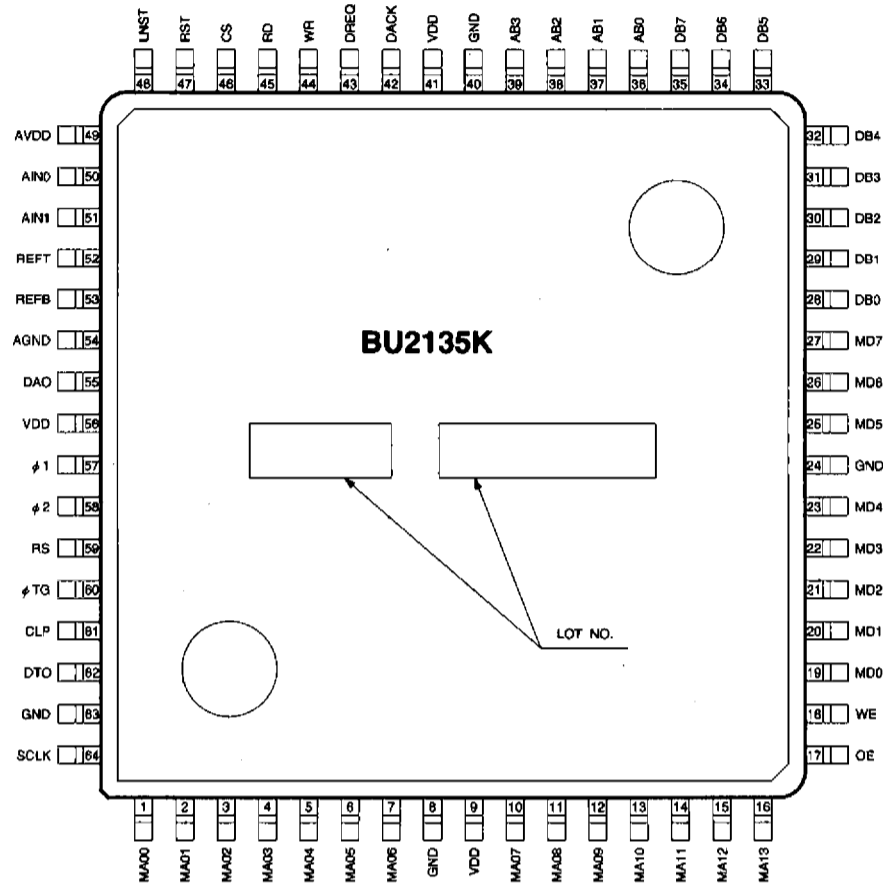

FAX  Image processing ASSP for FAX

Fig. 1

●Input/output circuit formats

Pin No.	I/O	Pin Name	I/O Circuit Format	Pin No.	I/O	Pin Name	I/O Circuit Format
1	O	MA00	C	33	I/O	DB5	E
2	O	MA01	C	34	I/O	DB6	E
3	O	MA02	C	35	I/O	DB7	E
4	O	MA03	C	36	I	AB0	B
5	O	MA04	C	37	I	AB1	B
6	O	MA05	C	38	I	AB2	B
7	O	MA06	C	39	I	AB3	B
8	G	GND	—	40	G	GND	—
9	V	V _{DD}	—	41	V	V _{DD}	—
10	O	MA07	C	42	I/O	DACK	E
11	O	MA08	C	43	O	DREQ	C
12	O	MA09	C	44	I	WR	B
13	O	MA10	C	45	I	RD	B
14	O	MA11	C	46	I	CS	A
15	O	MA12	C	47	I	RST	A
16	O	MA13	C	48	I	LNST	A
17	O	OE	C	49	V	AV _{DD}	—
18	O	WE	C	50	I	AIN0	F
19	I/O	MD0	D	51	I	AIN1	F
20	I/O	MD1	D	52	—	REF+	G
21	I/O	MD2	D	53	—	REF—	G
22	I/O	MD3	D	54	G	AGND	—
23	I/O	MD4	D	55	O	DAO	H
24	G	GND	—	56	V	V _{DD}	—
25	I/O	MD5	D	57	O	φ1	C
26	I/O	MD6	D	58	O	φ2	C
27	I/O	MD7	D	59	O	RS	C
28	I/O	DB0	E	60	O	φTG	C
29	I/O	DB1	E	61	O	CLP	C
30	I/O	DB2	E	62	O	DTO	C
31	I/O	DB3	E	63	G	GND	—
32	I/O	DB4	E	64	I	SCLK	A

● Input/output circuits

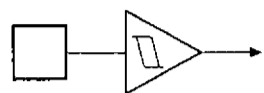

(A) Schmitt input cell

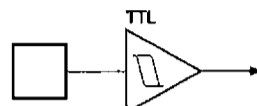

(B) TTL Schmitt input cell

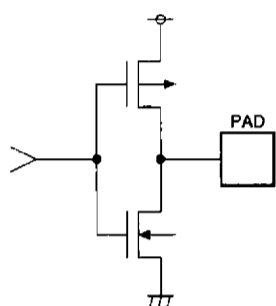

(C) CMOS output cell

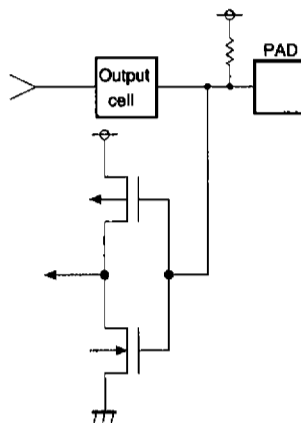

(D) Bi-directional CMOS Input pull-up cell

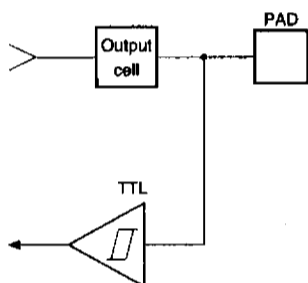

(E) Bi-directional TTL Schmitt input cell

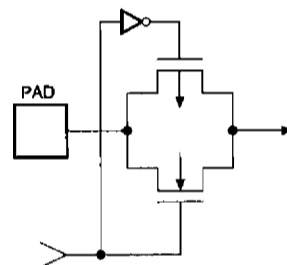

(F) Analog input cell



(G) Reference voltage input cell



(H) Analog output cell

FAX Image processing ASSP for FAX

●DC characteristics (Unless otherwise noted, $T_a=25^\circ\text{C}$, $V_{DD}=5\text{V}$)

Parameter	Symbol	Min.	Typ.	Max.	Unit	Conditions
Input voltage "H"	V_{IH1}	3.5	—	V_{DD}	V	CMOS level
Input voltage "L"	V_{IL1}	0	—	1.5	V	CMOS level
Input voltage "H"	V_{IH2}	2.4	—	V_{DD}	V	TTL Schmitt
Input voltage "L"	V_{IL2}	0	—	0.8	V	TTL Schmitt
Input voltage "H"	V_{IH3}	2.7	—	4.0	V	CMOS Schmitt
Input voltage "L"	V_{IL3}	1.3	—	2.0	V	CMOS Schmitt
Hysteresis voltage	V_H	0.4	—	1.8	V	Schmitt level
Input current "H"	I_{IH}	—	—	-10	μA	$V_{IH}=V_{DD}$
Input current "L"	I_{IL}	—	—	10	μA	$V_{IL}=\text{GND}$
Output voltage "H" 1	V_{OH1}	4.6	—	—	V	$I_{OH1}=-1.0\text{mA}$
Output voltage "L" 1	V_{OL1}	—	—	0.4	V	$I_{OL1}=3.2\text{mA}$
Output voltage "H" 2	V_{OH2}	4.6	—	—	V	$I_{OH2}=-2.0\text{mA}$
Output voltage "H" 3	V_{OH3}	4.6	—	—	V	$I_{OH3}=-3.5\text{mA}$
Output voltage "L" 3	V_{OL3}	—	—	0.4	V	$I_{OL3}=11.2\text{mA}$
Output leakage current	I_{OZ}	—	—	± 10	μA	$V_O=V_{DD}$ or GND
Static current consumption	I_{ST}	—	—	100	μA	$V_i=V_{DD}$ or GND

* 1 V_{IH1} and V_{IL1} are applied to Pins MD0 to 7.

* 2 V_{IH2} and V_{IL2} are applied to Pins DB0 to 7, AB0 to 3, DACK, WR, and RD.

* 3 V_{IH3} and V_{IL3} are applied to Pins CS, RST, LNST, and SCLK.

* 4 V_H is applied to pins DB0 to 7, AB0 to 3, DACK, WR, RD, CS, RST, LNST, and SCLK.

* 5 V_{OH1} is applied to the DACK pin.

* 6 V_{OL1} is applied to Pins MA0 to 13, OE, WE, MD0 to 7, DACK, DREQ, $\phi 1$, $\phi 2$, RS, ϕ TG, CLP, and DTO.

* 7 V_{OH2} is applied to Pins MA0 to 13, OE, WE, MD0 to 7, DREQ, $\phi 1$, $\phi 2$, RS, ϕ TG, CLP, and DTO.

* 8 V_{OH3} and V_{OL3} are applied to Pins DB0 to 7.

●Switching characteristics (Unless otherwise noted, Ta=25°C, Vcc=5V)

Parameter		Symbol	Min.	Typ.	Max.	Unit
System clock	System clock cycle tcyc	1	60	—	—	ns
	System clock pulse width "H" twh	2	30	—	—	ns
	System clock pulse width "L" twl	3	30	—	—	ns
CPU interface	CS ~ WR, RD setup time	4	0	—	—	ns
	AAB ~ WR, RD setup time	5	20	—	—	ns
	DB ~ WR setup time	6	50	—	—	ns
	WR, RD pulse width	7	100	—	—	ns
	WR, RD ~ CS hold time	8	0	—	—	ns
	WR, RD ~ AB hold time	9	20	—	—	ns
	WR ~ DB hold time	10	20	—	110	ns
	RD ~ DB hold time	10	0	—	—	ns
SRAM interface	Read cycle time	11	—	tcyc	—	ns
	MA, MCS ~ OE setup time	12	—	twh	—	ns
	OE pulse width	13	—	twl	—	ns
	OE ~ MA, MCS hold time	14	0	—	—	ns
	Write cycle time	15	—	tcyc	—	ns
	MA, MCS ~ WE setup time	16	—	twh	—	ns
	MA, MCS ~ WE setup time	17	—	twl	—	ns
	WE pulse width	18	—	twl	—	ns
	WE ~ MA, MCS hold time	19	0	—	—	ns
WE ~ MD hold time	20	0	—	—	ns	

SYSTEM CLOCK

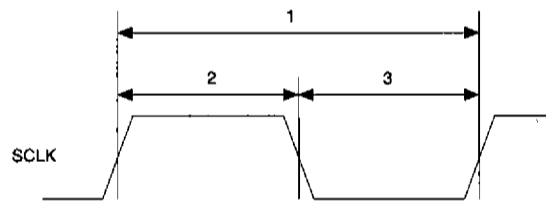

Image processing ASSP for FAX

FAX

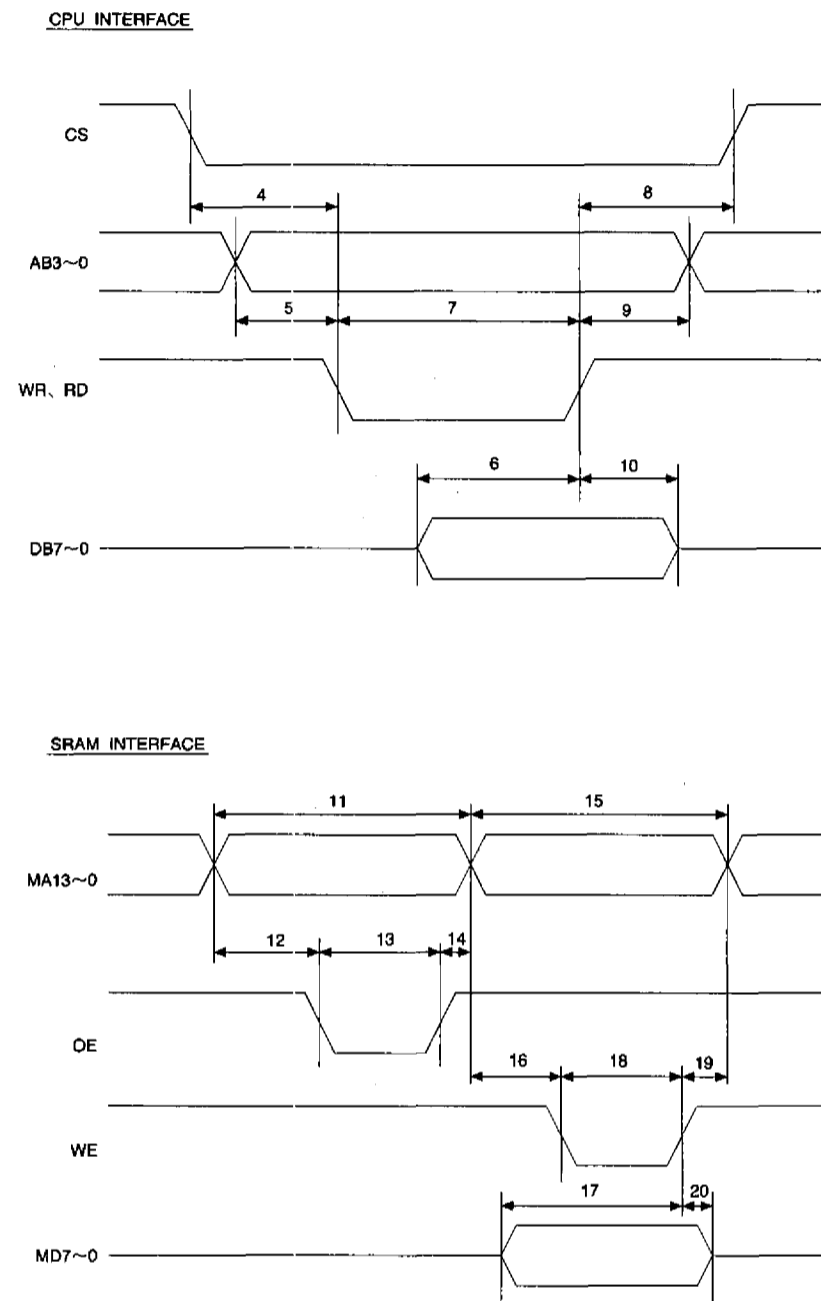

Fig. 2 Data input/output timing

●Description of register functions

Address	DB7	DB6	DB5	D4	DB3	DB2	DB1	DB0	R	W	
0	*8	*7	*6	*5	*4	*3	*2	*1	○	○	
1	*14	*13			*12	*11	*10	*9	×	○	
2	*21	*20	*19	*18	*17	*16	*15		×	○	
3	Line clamp/start position MSB is #				*22				×	○	
4	#	Line clamp/end position							×	○	
5	Distortion correction start position								×	○	
6	\$	ABC start position							×	○	
7	ABC end position; MSB is \$								×	○	
8	*23								○	○	
9	*24								×	○	
A	*26				*25				×	○	
B	*28	*27							×	○	
C	*30				*29				×	○	
D	*32				*31				×	○	
E	*35	*34				*33				×	○
F	D/A converter digital data								×	○	
FU	*38	*37	*36	0	0	0	0	0	×	○	

- *1 White reference screen scan (read enabled)
When 0 : Stop
When 1 : Start
- *2 Offset scan (read enabled)
When 0 : Stop
When 1 : Start
- *3 Binary processing (read enabled)
When 0 : Stop
When 1 : Start
- *4 ABC Enable (read enabled)
When 0 : Off
When 1 : On
- *5 ABC initialization
When 0 : Off
When 1 : On
- *6 SRAM access select
When 0 : Access to external SRAM
1) When *35 is 0 and *38 is 0 : Read/write white reference data
2) When *35 is 0 and *38 is 1 : Read/write all addresses
3) When *35 is 1 and *38 is 0 : Read/write thresholds of applied binary data
4) When *35 is 1 and *38 is 1 : Use inhibited
When 1 : Access to internal SRAM
1) When using simple binary processing : 6 bits × 64 words (gamma correction data)
2) For dither method : 6 bits × 64 words (slice data)
3) For error dispersion method : 6 bits × 64 words (white level)
- *7 SRAM data/Write Enable
When 0 : Writing to SRAM from Address 8 is off
When 1 : Writing to SRAM from Address 8 is on
- *8 SRAM data/Read Enable
When 0 : Reading to SRAM from Address 8 is off
When 1 : Reading to SRAM from Address 8 is on

FAX Image processing ASSP for FAX

*9 Binary video signal output mode	
When 0 :	Binary video signals are output as serial data.
When 1 :	Binary video signals are output as parallel data.
*10 Parallel mode specification	
When 0 :	First bit of binary video signal is taken as LSB.
When 1 :	First bit of binary video signal is taken as MSB.
*11 Binary video signal selection	
When 0 :	Black = 0, White = 1
When 1 :	Black = 1, White = 0
*12 Offset correction	
When 0 :	Off
When 1 :	On
*13 Internal sample / hold timing	
When 000 :	Sampled at S1 cycle
When 001 :	Sampled at S2 cycle
When 010 :	Sampled at S3 cycle
When 011 :	Sampled at S4 cycle
When 100 :	Sampled at S5 cycle
When 101 :	Sampled at S6 cycle
When 110 :	Sampled at S7 cycle
When 111 :	Sampled at S0 cycle
*14 A/D converter channel switching	
When 0 :	Connected to AIN0
When 1 :	Connected to AIN1
*15 Image sensor	
When 0 :	CCD
When 1 :	CIS
*16 ϕ TG output logic	
When 0 :	Positive logic
When 1 :	Negative logic
*17 RS and CLP output logic	
When 0 :	Positive logic
When 1 :	Negative logic
*18 Clamping method	
When 0 :	Bit clamping
When 1 :	Line clamping
*19 ϕ 1 clock and RS output specification	
1) ϕ 1 clock duty (when using CIS)	
When 00 :	HIGH for S0 to S3 cycles, LOW for S4 to S7 cycles
When 01 :	HIGH for S0 to S3 cycles, LOW for S4 to S7 cycles
When 10 :	HIGH for S0 to S1 cycles, LOW for S2 to S7 cycles
When 11 :	HIGH for S0 to S5 cycles, LOW for S6 to S7 cycles
2) RS output position (when using CCD)	
When 00 :	Output at S5 cycle
When 01 :	Output at S6 cycle
*20 ϕ TG pulse width	
1) When using CCD	
When 0 :	Output at S1 to S6 cycles
When 1 :	Output at S0 to S7 cycles
2) When using CIS	
When 0 :	Output at S1 to S0 cycles
When 1 :	Output at S0 to S7 cycles

- *21 Back register enable
 When 0 : Register of Address F is valid.
 When 1 : Register of Address FU is valid.
- *22 Manuscript width specification

DB3	DB2	DB1	DB0	Distortion correction width	Reading width	Reading position
0	0	0	0	1728	1728 (A4, 8 dots/mm or equivalent)	
0	0	0	1	2048	1728 (A4, 8 dots/mm or equivalent)	Center
0	0	1	0	2048	2048 (B4, 8 dots/mm or equivalent)	
0	0	1	1	2432	1728 (A4, 8 dots/mm or equivalent)	Center
0	1	0	0	2432	2048 (B4, 8 dots/mm or equivalent)	Center
0	1	0	1	2432	2432 (A3, 8 dots/mm or equivalent)	
0	1	1	0	2592	2592 (A4, 12 dots/mm or equivalent)	
0	1	1	1	3072	2592 (A4, 12 dots/mm or equivalent)	Center
1	0	0	0	3072	3072 (B4, 12 dots/mm or equivalent)	
1	0	0	1	3648	2592 (A4, 12 dots/mm or equivalent)	Center
1	0	1	0	3648	3072 (B4, 12 dots/mm or equivalent)	Center
1	0	1	1	3648	3648 (A3, 12 dots/mm or equivalent)	
1	1	0	0	3456	3456 (A4, 16 dots/mm or equivalent)	
1	1	0	1	4096	3456 (A4, 16 dots/mm or equivalent)	Center
1	1	1	0	4096	4096 (A4, 16 dots/mm or equivalent)	

- *23 Numerator of reduction ratio in horizontal direction
 - *24 Denominator of reduction ratio in horizontal direction *23
- The reduction ratio is set as shown below, using Address 8 (numerator) and Address 9 (denominator).

$$\text{Reduction ratio} = \frac{(\text{value set for reduction ratio numerator}) + 1}{(\text{value set for reduction ratio denominator}) + 1}$$

- *25 Black follow-up speed
 When 0 : ABC circuit not followed on dark background
 When 1 to 15 : The larger the set value, the faster the ABC is followed on a dark background.
- *26 White follow-up speed
 When 0 : ABC circuit not followed on light background
 When 1 to 15 : The larger the set value, the faster the ABC is followed on a light background.
- *27 Binary parameter
 1) For simple binary processing : Set the slice level.
 2) For organizational dither processing : This parameter is invalid.
 3) For error dispersion processing : Set the black level.
- *28 Binary mode
 When 00 : Simple binary processing
 When 01 : Simple binary processing
 When 10 : Pseudo intermediate processing using organizational dither method
 When 11 : Pseudo intermediate processing using error dispersion method
- *29 Degree of edge enhancement in horizontal direction
 When 0 : Edge enhancement off
 When 1 to 15 : The larger the set value, the stronger the enhancement will be.
- *30 Degree of edge enhancement in vertical direction
 When 0 : Edge enhancement off
 When 1 to 15 : The larger the set value, the stronger the enhancement will be.

Image processing ASSP for FAX

FAX

- *31 Edge enhancement correction parameter
This parameter is used as a threshold to judge whether edge enhancement or smoothing is to be carried out when the amount of density of the pixel edge in question changes.
- *32 Degree of smoothing
When 0 : Smoothing function off
When 1 to 6 : The larger the set value, the greater the degree of smoothing that is carried out.
When 7 : Use inhibited
- *33 Character enhancement parameter B
When pseudo intermediate processing is used, this parameter is used as a threshold to determine whether or not edge enhancement is to be carried out when the amount of density in both the horizontal and vertical directions is changed.
- *34 Character enhancement parameter A
1) This parameter defines character enhancement when pseudo intermediate processing is used.
2) When using the dither method
When 000 : Character enhancement off
When 001 to 111 : The larger the set value, the stronger the enhancement will be.
3) When using the error dispersion method
When 000 : Character enhancement off
When 001 to 111 : The larger the set value, the stronger the enhancement will be.
- *35 Applied binary enable
When 0 : When using simple binary processing, the slice level is determined by the binary parameter.
When 1 : When using simple binary processing, the slice level is determined by the average density.
- *36 Expansion port enable
When 0 : No expansion ports are used.
When 1 : Pin 16 (MA13) is used as the expansion port.
- *37 Expansion port data
When 0 : The expansion port data is 0.
When 1 : The expansion port data is 1.
- *39 Resetting the internal registers of Addresses 0 to 2 and Address FU clears the values to 0.
The set values for other internal registers do not change when a reset is initiated.
- *40 Register setting unit
1) The line clamping start and end positions can be specified in units of 1 pixel.
2) The distortion correction start position can be specified in units of 1 pixel.
3) The ABC start and end positions can be specified in units of 16 pixels.
- *41 In the following cases, Address 8 should be used for reading and writing of data.
1) Reading digital data after A/D conversion
2) Reading and writing internal SRAM data
3) Reading and writing external SRAM data

● Operation timing charts

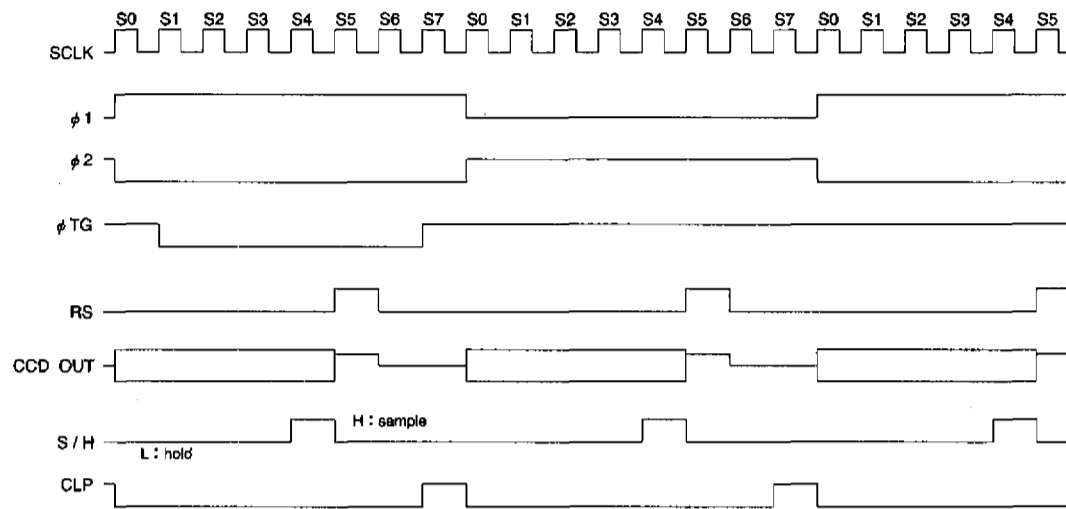

Fig. 3 CCD drive timing diagram -1

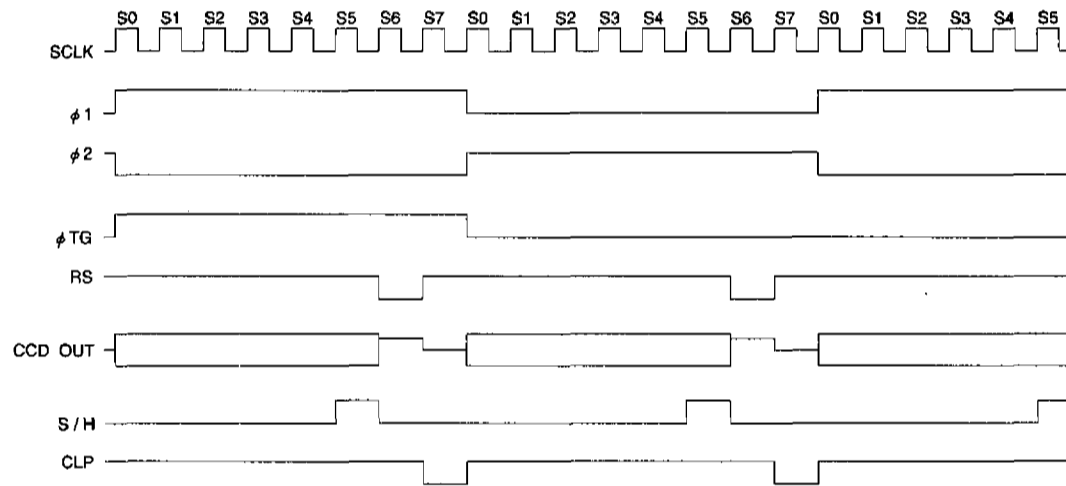

Fig. 4 CCD drive timing diagram -2

Image processing ASSP for FAX

FAX

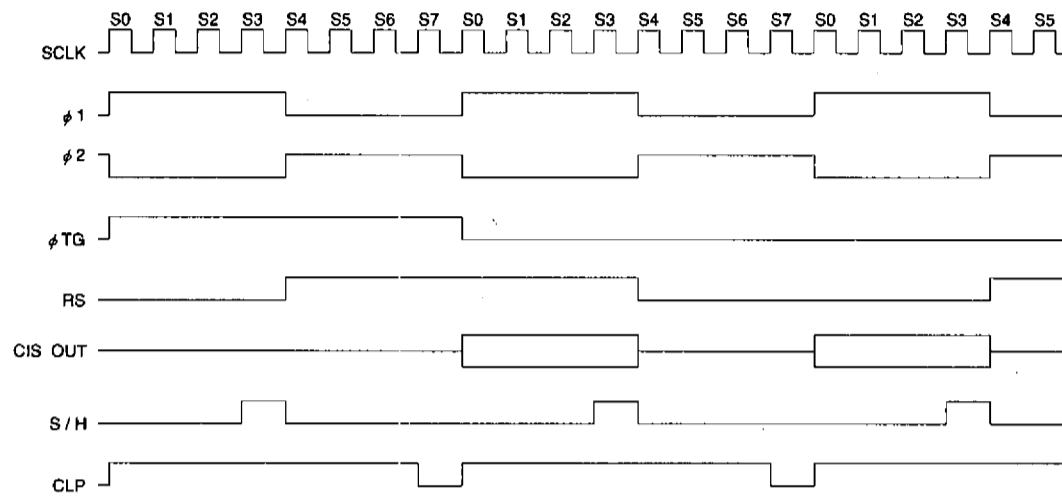

Fig. 5 CIS drive timing diagram -1

● Operation timing charts

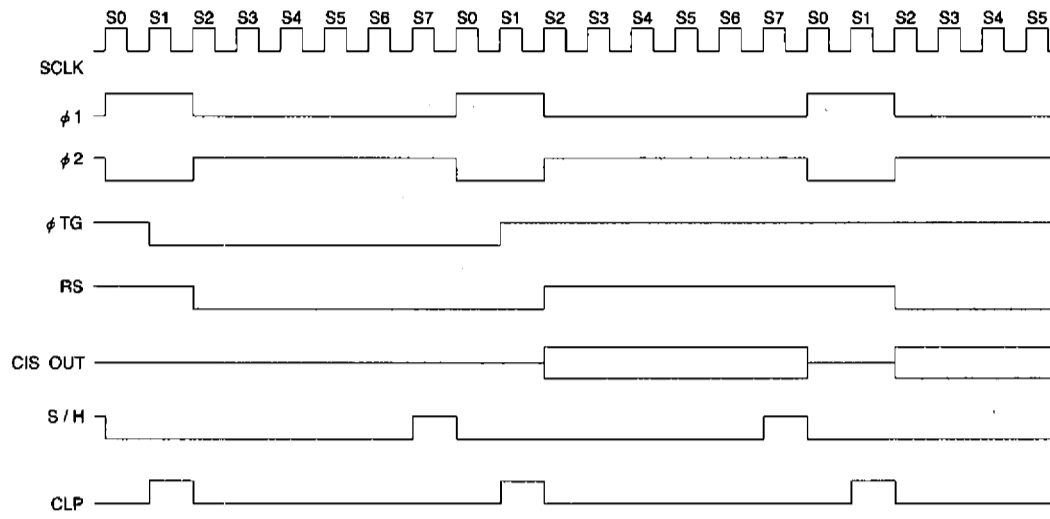

Fig. 6 CIS drive timing diagram -2

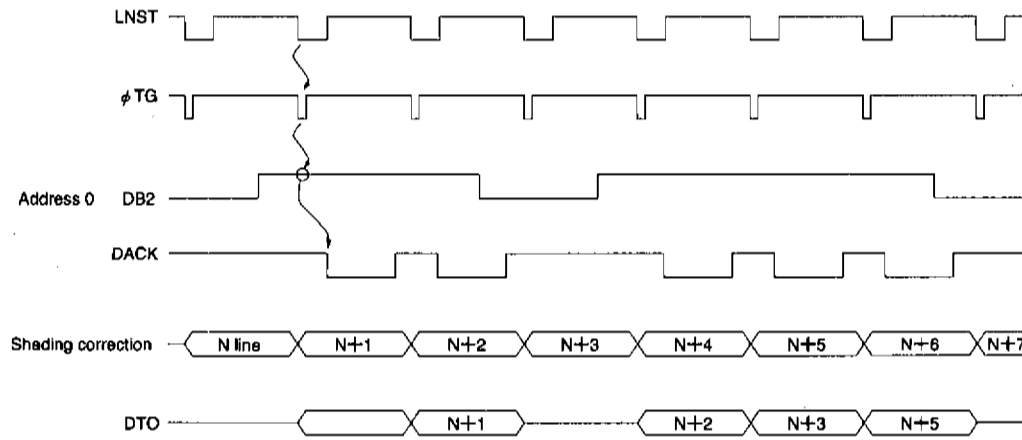

Fig. 7 Line control timing diagram

Image processing ASSP for FAX

FAX

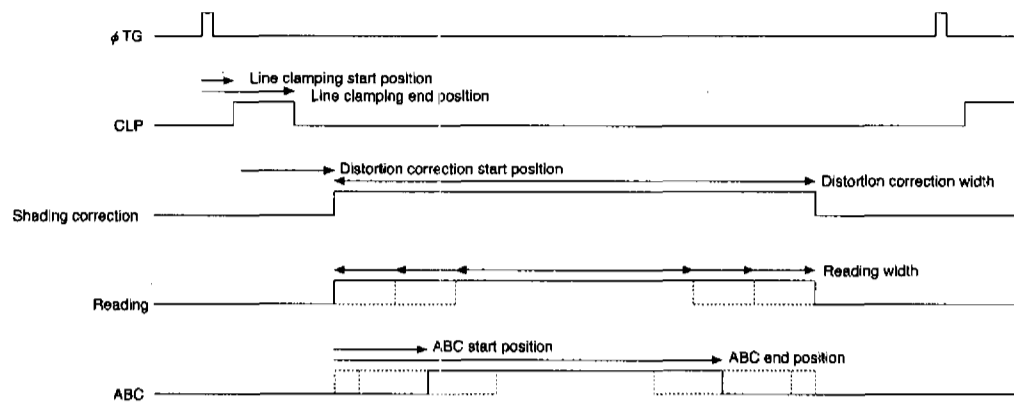

Fig. 8 Scan timing diagram

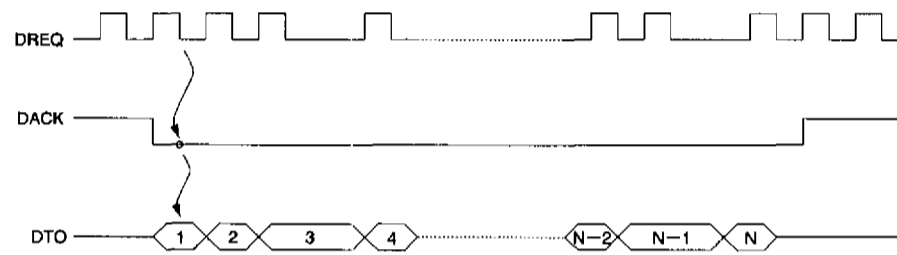

Fig. 9 Output timing diagram (serial mode)

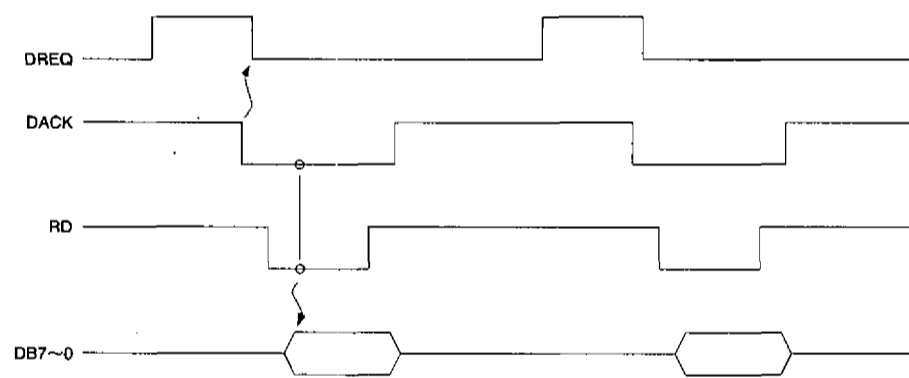

Fig. 10 Output timing diagram (parallel mode)

●Application example

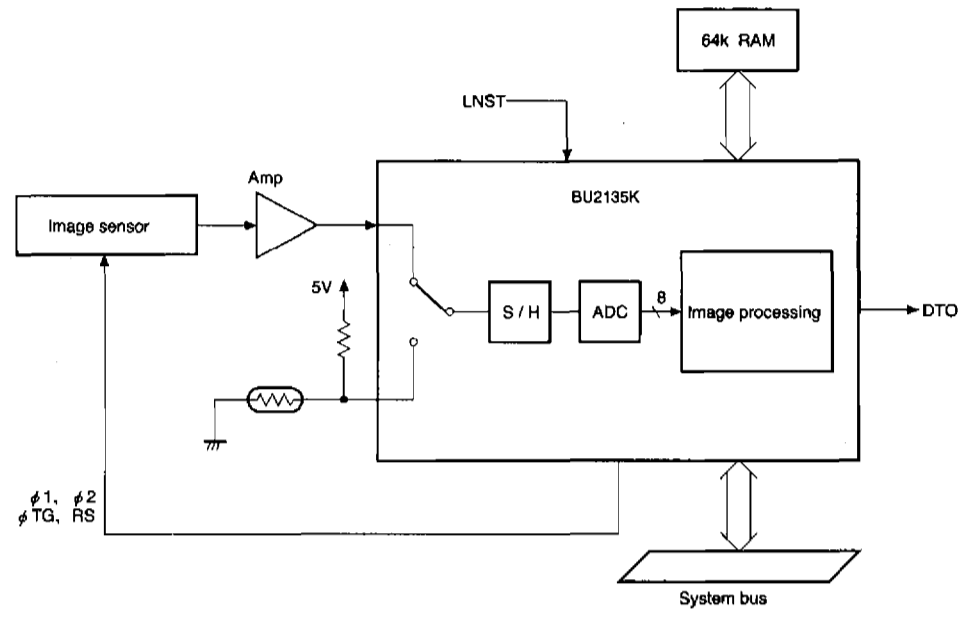
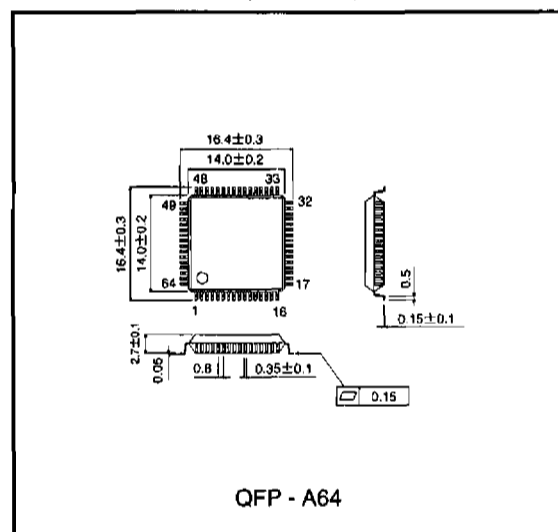

Fig. 11

Image processing ASSP for FAX

●External dimensions (Units: mm)



Notes

- The contents described in this catalogue are correct as of March 1997.
- No unauthorized transmission or reproduction of this book, either in whole or in part, is permitted.
- The contents of this book are subject to change without notice. Always verify before use that the contents are the latest specifications. If, by any chance, a defect should arise in the equipment as a result of use without verification of the specifications, ROHM CO., LTD., can bear no responsibility whatsoever.
- Application circuit diagrams and circuit constants contained in this data book are shown as examples of standard use and operation. When designing for mass production, please pay careful attention to peripheral conditions.
- Any and all data, including, but not limited to application circuit diagrams, information, and various data, described in this catalogue are intended only as illustrations of such devices and not as the specifications for such devices. ROHM CO., LTD., disclaims any warranty that any use of such device shall be free from infringement of any third party's intellectual property rights or other proprietary rights, and further, assumes absolutely no liability in the event of any such infringement, or arising from or connected with or related to the use of such devices.
- Upon the sale of any such devices; other than for the buyer's right to use such devices itself, resell or otherwise dispose of the same; no express or implied right or license to practice or commercially exploit any intellectual property rights or other proprietary rights owned or controlled by ROHM CO., LTD., is granted to any such buyer.
- The products in this manual are manufactured with silicon as the main material.
- The products in this manual are not of radiation resistant design.

The products listed in this catalogue are designed to be used with ordinary electronic equipment or devices (such as audio-visual equipment, office-automation equipment, communications devices, electrical appliances, and electronic toys). Should you intend to use these products with equipment or devices which require an extremely high level of reliability and the malfunction of which would directly endanger human life (such as medical instruments, transportation equipment, aerospace machinery, nuclear-reactor controllers, fuel controllers, or other safety devices) please be sure to consult with our sales representatives in advance.

- Notes when exporting
 - It is essential to obtain export permission when exporting any of the above products when it falls under the category of strategic material (or labor) as determined by foreign exchange or foreign trade control laws.
 - Please be sure to consult with our sales representatives to ascertain whether any product is classified as a strategic material.