

# ZMT32

## Magnetic Field Angle Sensor

### Description

The ZMT32 is a thin film permalloy magnetic field sensor, which contains two galvanic isolated Wheatstone Bridges for high precision angle measurement applications under low field conditions. This angle sensor is based on the anisotropic magnetoresistive effect (AMR). The two internal ( $V_{CC1}$ ,  $V_{CC2}$ ) bridges enclose a relative sensitive angle of 45 degrees. The input field is a rotating magnetic field in the chip plane (parallel to the surface of package). This rotating field will make available two independent sinusoidal output signals with the following relationship

$$\frac{V_{O2}}{V_{O1}} = \frac{\sin(2\alpha)}{\cos(2\alpha)} = \tan(2\alpha)$$

where  $\alpha$  = angle between sensor axis and field direction

### Features

- contactless angle measurement up to 180°
- flexible measuring solutions for moved systems
- stable operation over long time
- high temperature range up to +160°C

The precise ZMT32 works with low field applications ( $H_{rot} = 8$  to 25kA/m), much lower than similar devices. The ultimate output signal quality depends on the external magnetic material and on the mechanical realization.

The ZMT32 is a passive part and the Arc-Tangent interpolation needs external signal processing. Typical areas of application are angle and speed measurement.

### Applications

- angle and angular velocity measuring systems
- absolute angle and angle change
- automotive electronic (steering, throttle control, pedal positioning, etc)
- contactless rotary switches and potentiometer
- automatic adjustment

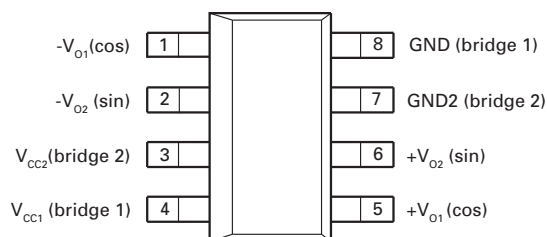

### Ordering Information

Device	Reel size (Inches)	Tape width (mm)	Quantity per reel	Device marking
ZMT32TA	7	12	1,000	ZETEX ZMT32

## Absolute maximum ratings

Parameter	Symbol	Limit	Unit
Supply Voltages	$V_{cc1}$ and $V_{cc2}$	10	V
Single Bridge Current	$I_{cc1}$ or $I_{cc2}$	4	mA
Operating Temperature Range	$T_A$	-40 to +160	°C
Storage Temperature Range	$T_{stg}$	-55 to +175	°C

## Recommended operating conditions

Symbol	Parameter	Min	Typ	Max	Unit
$V_{cc1}, V_{cc2}$	Supply Voltages		5	8.5	V
$H_{rot}$	Applied Magnetic Field Strength	8	25		kA/m

## Electrical characteristics

General test conditions (unless otherwise noted)

$T_A = +23 \pm 5^\circ\text{C}$ ,  $V_{CC1} = V_{CC2} = +5\text{V}$ ,  $H_{ROT} = 25\text{kA/m}^{(†)}$ ,  $k = 100 \cdot (V_{PO1}/V_{PO2})$  with  $V_{CC1} = V_{CC2}$

SYMBOL	PARAMETER	CONDITIONS	MIN	TYP (*)	MAX	UNIT
$S_{\alpha 1}$ or $S_{\alpha 2}$	Sensitivities (zero crossing)	$\alpha 1 = 135^\circ$ , $\alpha 2 = 0^\circ$		0.35		mV/V/deg
$V_{PO1}$ or $V_{PO2}$	Peak Output Voltages (sinusoidal signals)		40	50	60	mV
k	Amplitude bridge matching		99.77	100	100.23	%
TCk	Temperature coefficient of amplitude bridge matching	$T_A = -40$ to $+160^\circ\text{C}$	-0.008		+0.008	%/K
$R_{B1}$ or $R_{B2}$	Bridge resistances	no $H_{ROT}$	$T_A = -40^\circ\text{C}$ $T_A = 23^\circ\text{C}$ $T_A = +160^\circ\text{C}$	2017 3000 3345	3040 3600 5114	$\Omega$
$TCR_B^B$	TC of Bridge Resistances		+0.28	+0.32	+0.36	%/K
$\Delta V_{O1}/V_{CC1}^A$ or $\Delta V_{O2}/V_{CC2}^A$	Peak to peak output swing	$H_{ROT} = 8\text{ kA/m}^{(†)}$	$T_A = -40^\circ\text{C}$ $T_A = 23^\circ\text{C}$ $T_A = +160^\circ\text{C}$ $T_A = 23^\circ\text{C}$	19.2 16 6.7 16	30.4 20 13.4 24	mV/V
$TCV_O^B$	TC of peak to peak output swing		-0.35	-0.32	-0.28	%/K
$V_{OFF1}/V_{CC1}^A$ or $V_{OFF2}/V_{CC2}^A$	Output offset voltage	$H_{ROT} = 8\text{ kA/m}^{(†)}$ no $H_{ROT}$	$T_A = -40^\circ\text{C}$ $T_A = +160^\circ\text{C}$ $T_A = 23^\circ\text{C}$	-1.25 -1.55 -1 -2	+1.25 +1.55 0 0	mV/V
$TCV_{OFF}^B$	TC of output offset voltage		-4	0	+4	$\mu\text{V/V/K}$
$\Delta\alpha^A$	Angular Inaccuracy			0.05	0.2	deg
$\Delta\alpha^A$	Angular hysteresis	$H_{ROT} = 8\text{ kA/m}^{(†)}$			0.1 0.5 (‡)	deg
$I_{iso1-2}$	Isolation Bridge Current	no $H_{ROT}$	0		0.1	$\mu\text{A}$

### NOTES:

(\*) Typical values apply to an ambient temperature of  $23^\circ\text{C}$

(†) See point "Magnetic Field Tests" below

(‡) The accurate control of this parameter ( $\text{Lim}_{\text{max}} = 0.1\text{deg}$ ,  $H_{ROT} = 25\text{kA/m}$ ) takes place by means of sample tests

### A: Output characteristic definitions

$$\Delta V_{O1}/V_{CC1} = (V_{OMAX1} - V_{OMIN1})/V_{CC1} \quad \text{or} \quad \Delta V_{O2}/V_{CC2} = (V_{OMAX2} - V_{OMIN2})/V_{CC2}$$

$$V_{OFF1}/V_{CC1} = \frac{1}{2}(V_{OMAX1} + V_{OMIN1})/V_{CC1} \quad \text{or} \quad V_{OFF2}/V_{CC2} = \frac{1}{2}(V_{OMAX2} + V_{OMIN2})/V_{CC2}$$

$$\Delta\alpha^H = \text{MAX} | \alpha_{\text{LEFT TURN}} - \alpha_{\text{RIGHT TURN}} | \quad (\text{max. angular difference between left and right turn})$$

$$\Delta\alpha = \text{MAX} | \alpha_0 - \alpha | \quad (\text{max. angular difference between actual value } \alpha_0 \text{ and measured angle, without offset error})$$

### B: Temperature coefficient (TC) equations

$$T_1 = -25^\circ\text{C}, \quad T_0 = +25^\circ\text{C}, \quad T_2 = +125^\circ\text{C}$$

$$TCV_O = \frac{1}{T_2 - T_1} \times \frac{\frac{\Delta V_O}{V_{CC}}(T_2) - \frac{\Delta V_O}{V_{CC}}(T_1)}{\frac{\Delta V_O}{V_{CC}}(T_0)} \times 100\%$$

where  $\frac{\Delta V_O}{V_{CC}}(T_n)$  is the peak-peak output voltage at temperature  $T_n$

$$TCR_B = \frac{1}{T_2 - T_1} \times \frac{R_B(T_2) - R_B(T_1)}{R_B(T_0)} \times 100\%$$

where  $R_B(T_n)$  is the bridge resistance at temperature  $T_n$

$$TCV_{OFF} = \frac{V_{OFF(T_2)} - V_{OFF(T_1)}}{(T_2 - T_1)}$$

where  $V_{OFF(T_n)}$  is the output offset voltage at temperature  $T_n$

## Magnetic field tests

For these tests a rotating magnetic field is generated and the output signals of both bridges are measured at four different field angles for right rotation as well as for left rotation. Using these measured output signals the diameter and the center coordinates of the best circle are calculated. They correspond to the output voltage range and the offset voltage. Furthermore the field angles for both rotation directions and angular hysteresis are calculated

$$[\text{measured angle}] = \alpha = \arctan\left(\frac{V_{O2}}{V_{O1}}\right)$$

## Method

The data pairs are transformed onto a unit circle starting from their position in the data collection for determining direction information or angle information.

It must be evaluated with four pair values (cos, sin) on a right rotation (magnetic field rotation) and four pair values (cos, sin) on a left rotation (magnetic field rotation).

## The field rotation steps are:

- start in 180° position
  - § right rotation to 22.5° with measurement of sensor outputs
  - § right rotation to 67.5° with measurement of sensor outputs
  - § right rotation to 112.5° with measurement of sensor outputs
  - § right rotation to 157.5° with measurement of sensor outputs
  - § right rotation to 0° (360°) , stop , reversal
  - § left rotation to 157.5° with measurement of sensor outputs
  - § left rotation to 112.5° with measurement of sensor outputs
  - § left rotation to 67.5° with measurement of sensor outputs
  - § left rotation to 22.5° with measurement of sensor outputs , end position

General description of tests with external magnetic field.

## Operating principle

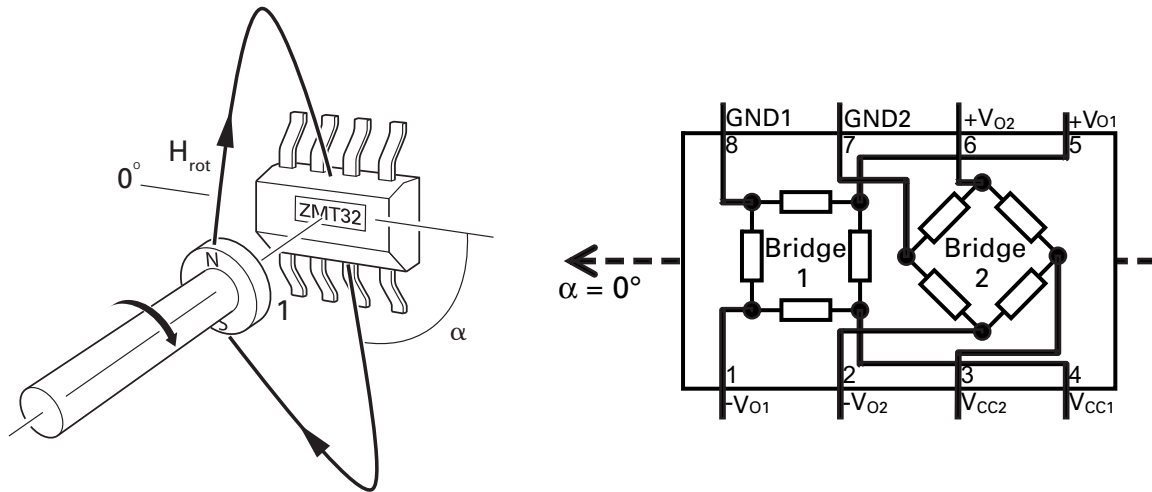

When a common-magnetic field is applied through the ZMT32 the 2 internal magneto-resistive bridges are affected slightly differently due to their 45° rotation to one another. This 45° rotation enables the ZMT32 to determine angular position, of a rotating magnetic field.

When a rotating magnetic field is applied to the ZMT32 it will output 2 sinusoidal voltages that are:

- proportional to the field strength applied
- proportional to the supply voltage applied,
- rotating at twice the angular position
- 90° apart (as seen below).

By taking the arcTan of the ratio of  $V_{O2}$  to  $V_{O1}$  the angular position of the magnetic field can be determined.

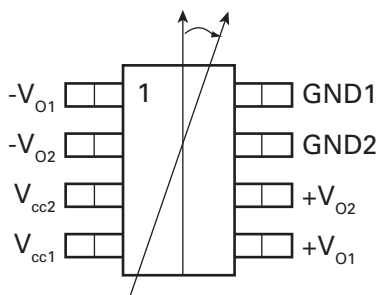

## Characteristic output curves $V_{O1}$ , $V_{O2}$

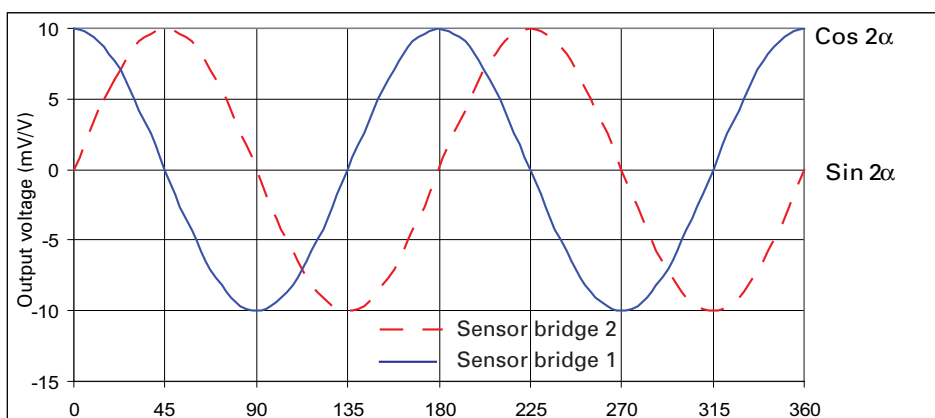

## Typical characteristics

### Accuracy variance with field strength

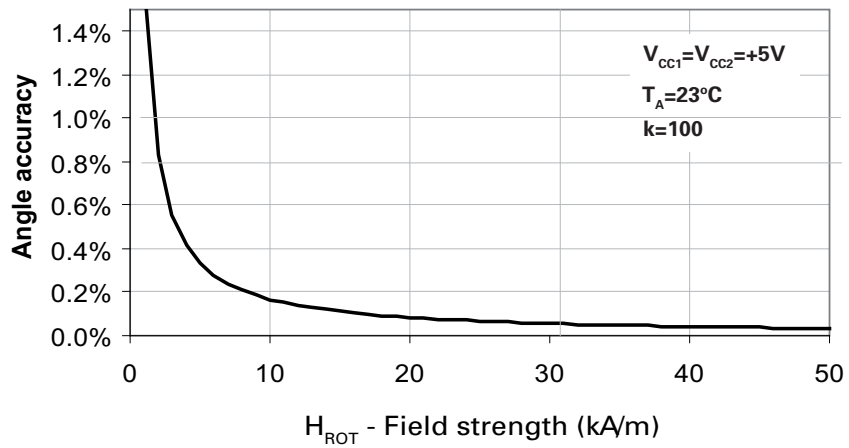

### Output variance with magnetic field strength

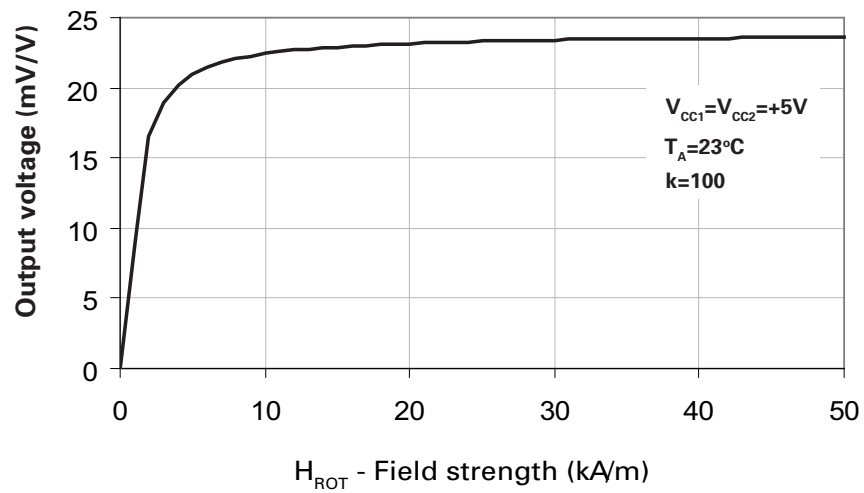

## Typical characteristics

Output voltage versus temperature

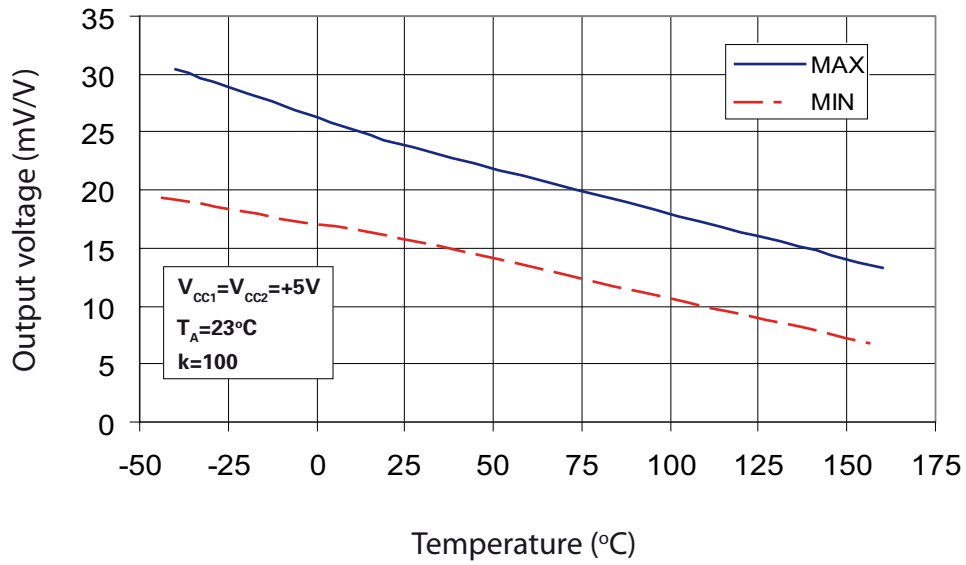

Bridge resistance versus temperature

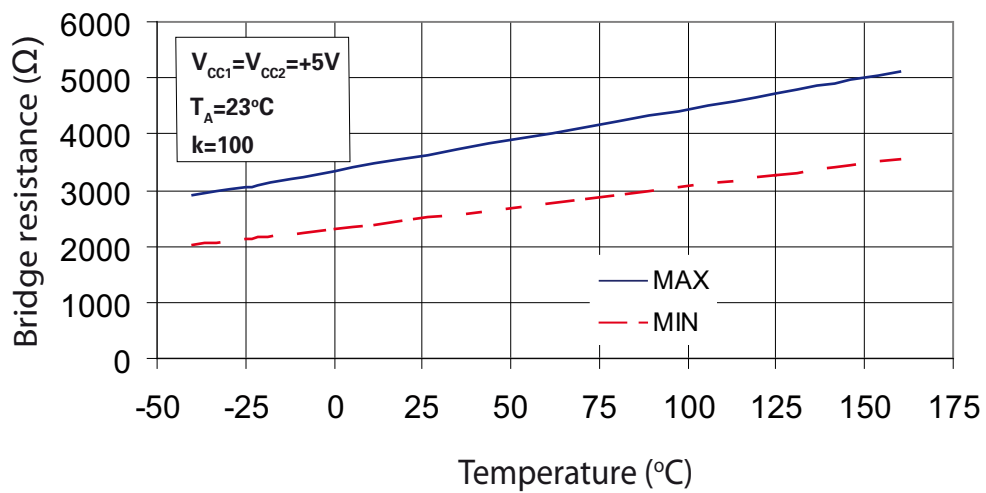

## Typical application

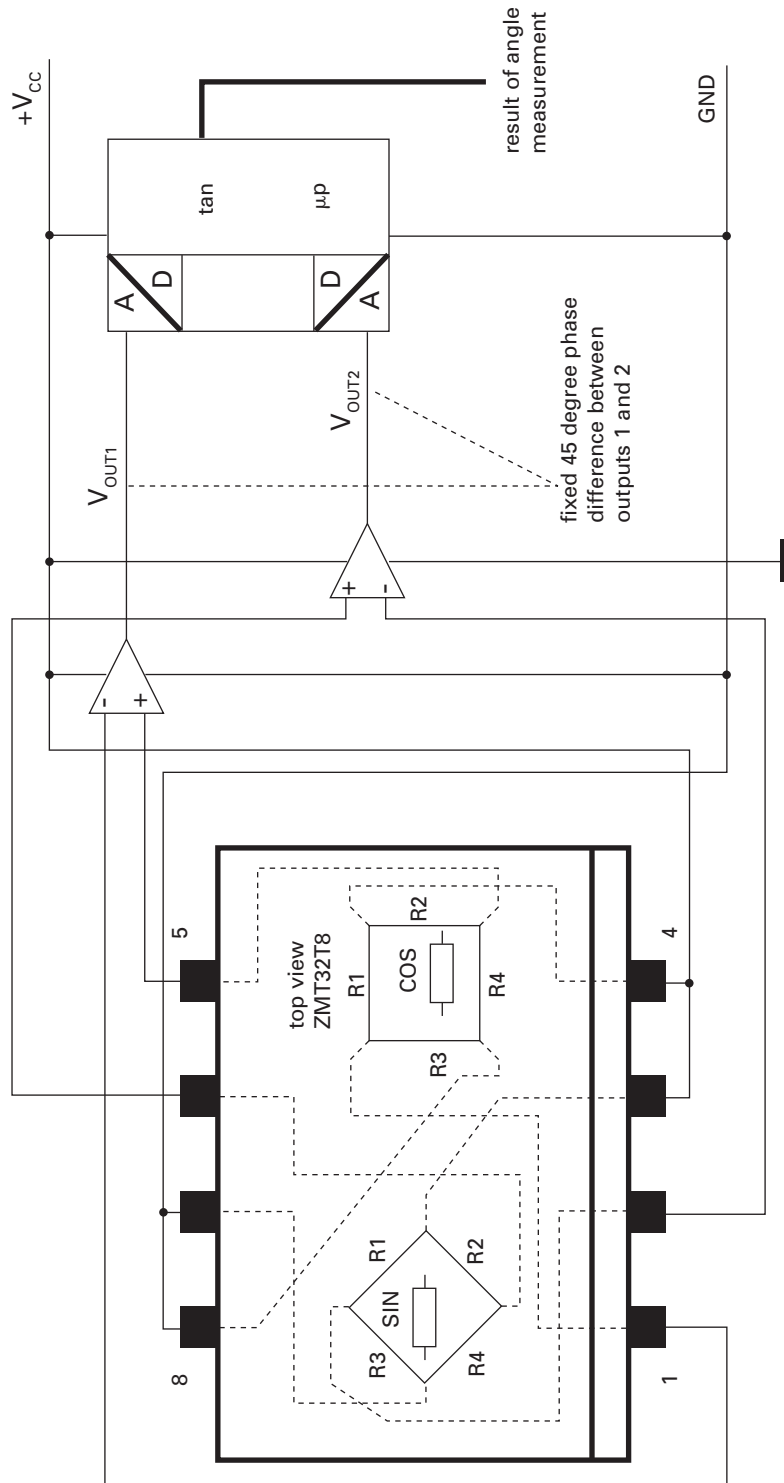



## Package outline - SM-8

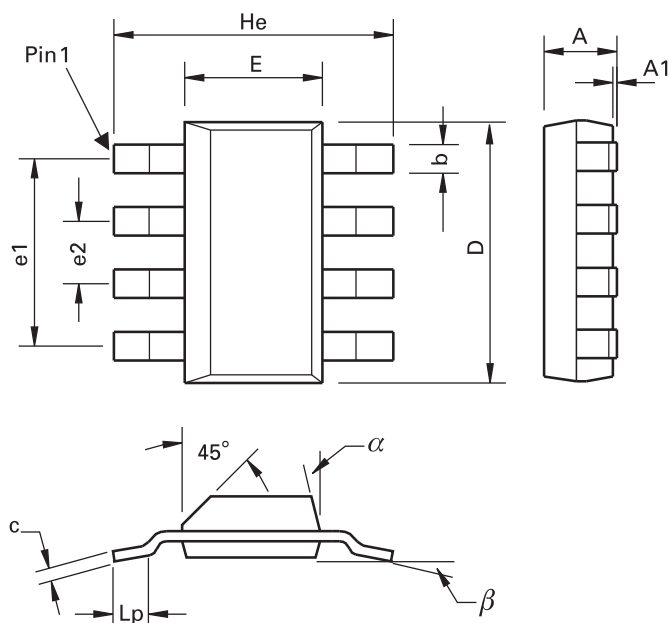

## Soldering footprint

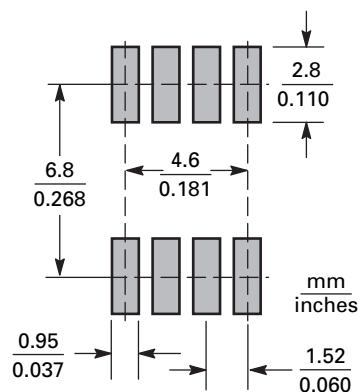

DIM	Millimeters			Inches			DIM	Millimeters			Inches		
	Min.	Max.	Typ.	Min.	Max.	Typ.		Min.	Max.	Typ.	Min.	Max.	Typ.
A	-	1.7	-	-	0.067	-	e1	-	-	4.59	-	-	0.1807
A1	0.02	0.1	-	0.0008	0.004	-	e2	-	-	1.53	-	-	0.0602
b	-	-	0.7	-	-	0.0275	He	6.7	7.3	-	0.264	0.287	-
c	0.24	0.32	-	0.009	0.013	-	Lp	0.9	-	-	0.035	-	-
D	6.3	6.7	-	0.248	0.264	-	$\alpha$	-	15°	-	-	15°	-
E	3.3	3.7	-	0.130	0.145	-	$\beta$	-	-	10°	-	-	10°

**Note:** Controlling dimensions are in millimeters. Approximate dimensions are provided in inches

## Definitions

### Product change

Zetex Semiconductors reserves the right to alter, without notice, specifications, design, price or conditions of supply of any product or service. Customers are solely responsible for obtaining the latest relevant information before placing orders.

### Applications disclaimer

The circuits in this design/application note are offered as design ideas. It is the responsibility of the user to ensure that the circuit is fit for the user's application and meets with the user's requirements. No representation or warranty is given and no liability whatsoever is assumed by Zetex with respect to the accuracy or use of such information, or infringement of patents or other intellectual property rights arising from such use or otherwise. Zetex does not assume any legal responsibility or will not be held legally liable (whether in contract, tort (including negligence), breach of statutory duty, restriction or otherwise) for any damages, loss of profit, business, contract, opportunity or consequential loss in the use of these circuit applications, under any circumstances.

### Life support

Zetex products are specifically not authorized for use as critical components in life support devices or systems without the express written approval of the Chief Executive Officer of Zetex Semiconductors plc. As used herein:

A. Life support devices or systems are devices or systems which:

1. are intended to implant into the body

or

2. support or sustain life and whose failure to perform when properly used in accordance with instructions for use provided in the labelling can be reasonably expected to result in significant injury to the user.

B. A critical component is any component in a life support device or system whose failure to perform can be reasonably expected to cause the failure of the life support device or to affect its safety or effectiveness.

### Reproduction

The product specifications contained in this publication are issued to provide outline information only which (unless agreed by the company in writing) may not be used, applied or reproduced for any purpose or form part of any order or contract or be regarded as a representation relating to the products or services concerned.

### Terms and Conditions

All products are sold subjects to Zetex' terms and conditions of sale, and this disclaimer (save in the event of a conflict between the two when the terms of the contract shall prevail) according to region, supplied at the time of order acknowledgement.

For the latest information on technology, delivery terms and conditions and prices, please contact your nearest Zetex sales office.

### Quality of product

Zetex is an ISO 9001 and TS16949 certified semiconductor manufacturer.

To ensure quality of service and products we strongly advise the purchase of parts directly from Zetex Semiconductors or one of our regionally authorized distributors. For a complete listing of authorized distributors please visit: [www.zetex.com/salesnetwork](http://www.zetex.com/salesnetwork)

Zetex Semiconductors does not warrant or accept any liability whatsoever in respect of any parts purchased through unauthorized sales channels.

### ESD (Electrostatic discharge)

Semiconductor devices are susceptible to damage by ESD. Suitable precautions should be taken when handling and transporting devices. The possible damage to devices depends on the circumstances of the handling and transporting, and the nature of the device. The extent of damage can vary from immediate functional or parametric malfunction to degradation of function or performance in use over time. Devices suspected of being affected should be replaced.

### Green compliance

Zetex Semiconductors is committed to environmental excellence in all aspects of its operations which includes meeting or exceeding regulatory requirements with respect to the use of hazardous substances. Numerous successful programs have been implemented to reduce the use of hazardous substances and/or emissions.

All Zetex components are compliant with the RoHS directive, and through this it is supporting its customers in their compliance with WEEE and ELV directives.

### Product status key:

"Preview"	Future device intended for production at some point. Samples may be available
"Active"	Product status recommended for new designs
"Last time buy (LTB)"	Device will be discontinued and last time buy period and delivery is in effect
"Not recommended for new designs"	Device is still in production to support existing designs and production
"Obsolete"	Production has been discontinued

### Datasheet status key:

"Draft version"	This term denotes a very early datasheet version and contains highly provisional information, which may change in any manner without notice.
"Provisional version"	This term denotes a pre-release datasheet. It provides a clear indication of anticipated performance. However, changes to the test conditions and specifications may occur, at any time and without notice.
"Issue"	This term denotes an issued datasheet containing finalized specifications. However, changes to specifications may occur, at any time and without notice.

### Zetex sales offices

Europe	Americas	Asia Pacific	Corporate Headquarters
Zetex GmbH Kustermann-Park Balanstraße 59 D-81541 München Germany Telephone: (49) 89 45 49 49 0 Fax: (49) 89 45 49 49 49 europe.sales@zetex.com	Zetex Inc 700 Veterans Memorial Highway Hauppauge, NY 11788 USA Telephone: (1) 631 360 2222 Fax: (1) 631 360 8222 usa.sales@zetex.com	Zetex (Asia Ltd) 3701-04 Metroplaza Tower 1 Hing Fong Road, Kwai Fong Hong Kong Telephone: (852) 26100 611 Fax: (852) 24250 494 asia.sales@zetex.com	Zetex Semiconductors plc Zetex Technology Park, Chadderton Oldham, OL9 9LL United Kingdom Telephone: (44) 161 622 4444 Fax: (44) 161 622 4446 hq@zetex.com

© 2008 Published by Zetex Semiconductors plc

# Mouser Electronics

Authorized Distributor

Click to View Pricing, Inventory, Delivery & Lifecycle Information:

[Diodes Inc.:](#)

[ZMT32TA](#)