

# Hallogics® Hall Effect Sensors

## Types OHN3020U, OHS3020U

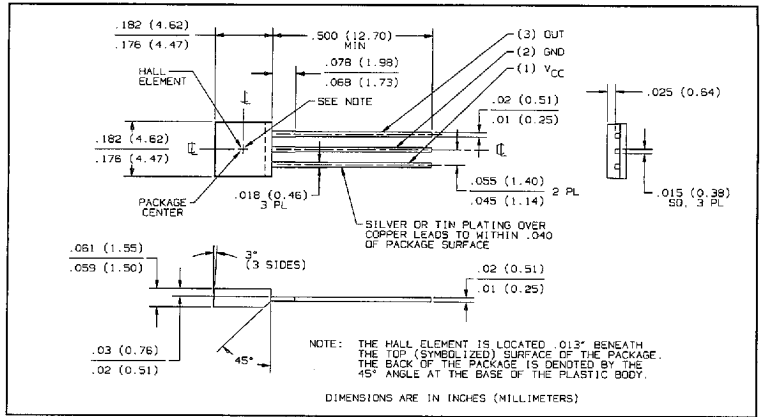
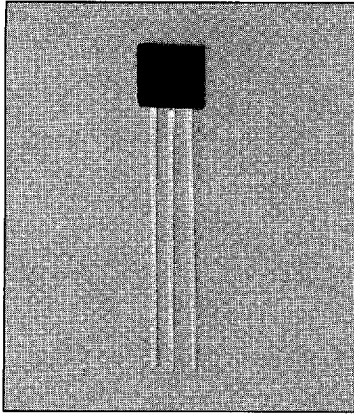

### Features

- Operates over a broad range of supply voltages
- Excellent temperature stability to operate in harsh environments
- Drive capability up to 7 TTL loads
- Hall element, linear amplifier, and Schmitt trigger on a single Hallogics® silicon chip

### Description

The OHN3020U and OHS3020U each contain a monolithic integrated circuit which incorporates a Hall element, a linear amplifier, and Schmitt trigger on a single silicon chip. In addition on-chip is a bandgap voltage regulator to allow operation with a wide range of supply voltages. The device features logic level output and provides up to 21 mA of sink current. This allows direct driving of more than 7 TTL loads or any standard logic family using power supplies ranging from 4.5 to 24 volts. Output amplitude is constant at switching frequencies from DC to over 200 kHz.

Stability of the magnetic operate and release points is excellent over this entire temperature range. The release point over the temperature range will always be greater than zero gauss.

Package size has been kept to minimum, providing an advantage in applications where space is limited.

### Absolute Maximum Ratings (TA = 25°C unless otherwise noted)

Supply Voltage, VCC	25 V
Storage Temperature Range, TS	-65°C to +150°C
Operating Temperature Range, TA	OHN3020U -20°C to +85°C
	OHS3020U -40°C to +125°C
Lead Soldering Temperature [1/8 inch (3.2 mm) from case for 5 sec. with soldering iron]	260°C <sup>(1)</sup>
Output ON Current, ISINK	25 mA
Output OFF Voltage, VOUT	25 V
Magnetic Flux Density, B	Unlimited

#### Note:

(1) Heat sink leads during hand soldering.

### Functional Block Diagram

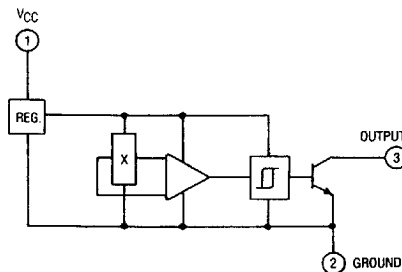

6798580 0002885 014

# Types OHN3020U, OHS3020U

Electrical Characteristics ( $V_{CC} = 4.5 \text{ V to } 24 \text{ VDC}$ ,  $T_A = 25^\circ \text{ C}$  unless otherwise noted)

SYMBOL	PARAMETER	MIN	TYP	MAX	UNITS	TEST CONDITIONS
B <sub>OP</sub>	Magnetic Operate Point <sup>(2)</sup>		230	350	Gauss	
B <sub>RP</sub>	Magnetic Release Point	50	180		Gauss	
B <sub>H</sub>	Magnetic Hysteresis	20	50		Gauss	
I <sub>CC</sub>	Supply Current		4	7	mA	$V_{CC} = 24 \text{ V}$ , Output Off
V <sub>OL</sub>	Output Saturation Voltage		100	400	mV	$V_{CC} = 4.5 \text{ V}$ , I <sub>OL</sub> = 20 mA, B ≥ 350 Gauss
I <sub>OH</sub>	Output Leakage Current		0.1	10.0	μA	$V_{CC} = 24 \text{ V}$ , V <sub>OUT</sub> = 24 V, B ≤ 50 Gauss
t <sub>r</sub>	Output Rise Time		0.21	1.00	μs	R <sub>L</sub> = 820 Ω, C <sub>L</sub> = 20 pF
t <sub>f</sub>	Output Fall Time		0.25	1.00	μs	

(2) South pole facing symbolized surface.

## Typical Performance Curves

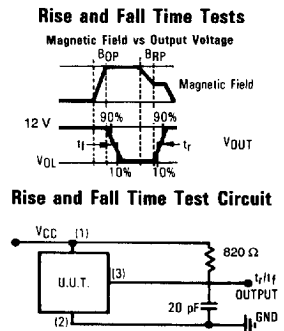
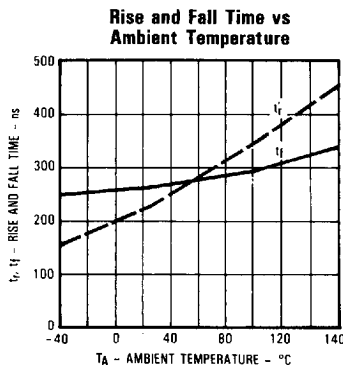
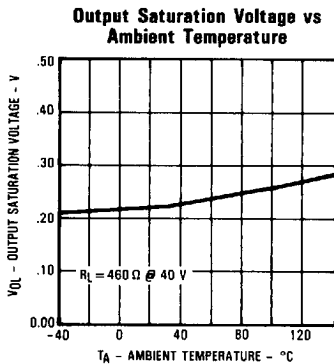
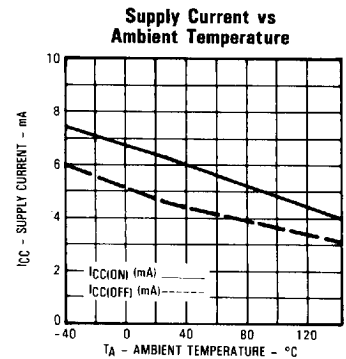
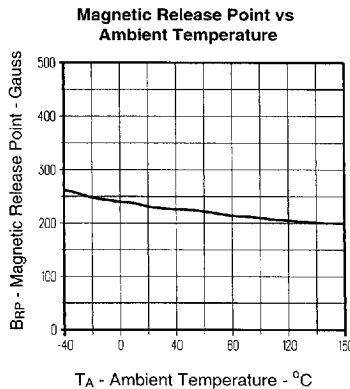
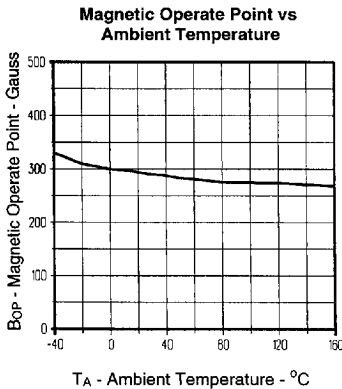

6798580 0002886 T50

Optek reserves the right to make changes at any time in order to improve design and to supply the best product possible.

Optek Technology, Inc. 1215 W. Crosby Road Carrollton, Texas 75006 (972)323-2200 Fax (972)323-2396