

Hall ICs

Unipolar Detection Hall ICs



BU52002GUL, BU52003GUL, BU52012NVX, BU52012HFV, BU52013HFV

No.10045ECT03

●Description

The unipolar Detection Hall IC detects only either the N pole or S pole.
The output turns ON (active Low) upon detection.

●Features

- 1) Unipolar detection
- 2) Micropower operation (small current using intermittent operation method)
- 3) Ultra-compact CSP4 package (BU52002GUL, BU52003GUL)
- 4) Ultra- Small outline package (BU52012NVX)
- 5) Small outline package (BU52012HFV, BU52013HFV)
- 6) Line up of supply voltage
For 1.8V Power supply voltage (BU52012NVX, BU52012HFV, BU52013HFV)
For 3.0V Power supply voltage (BU52002GUL, BU52003GUL)
- 7) High ESD resistance 8kV(HBM)

●Applications

Mobile phones, notebook computers, digital video camera, digital still camera, etc.

●Lineup matrix

Function	Product name	Supply voltage (V)	Operate point (mT)	Hysteresis (mT)	Period (ms)	Supply current (AVG.) (μA)	Output type	Package
S pole	BU52002GUL	2.40~3.30	3.7 *	0.8	50	6.5	CMOS	VCSP50L1
	BU52012NVX	1.65~3.60	3.0 *	0.9	50	3.5	COMS	SSON004X1216
	BU52012HFV	1.65~3.30	3.0 *	0.9	50	3.5	CMOS	HVSOF5
N pole	BU52003GUL	2.40~3.30	-3.7 *	0.8	50	6.5	CMOS	VCSP50L1
	BU52013HFV	1.65~3.30	-3.0 *	0.9	50	3.5	CMOS	HVSOF5

※Plus is expressed on the S-pole; minus on the N-pole

● Absolute maximum ratings

BU52002GUL, BU52003GUL (Ta=25°C)

Parameter	Symbol	Ratings	Unit
Power Supply Voltage	V _{DD}	-0.1~+4.5 ^{※1}	V
Output Current	I _{OUT}	±1	mA
Power Dissipation	P _d	420 ^{※2}	mW
Operating Temperature Range	T _{opr}	-40~+85	°C
Storage Temperature Range	T _{stg}	-40~+125	°C

※1. Not to exceed P_d

※2. Reduced by 4.20mW for each increase in Ta of 1°C over 25°C (mounted on 50mm × 58mm Glass-epoxy PCB)

BU52012NVX (Ta=25°C)

Parameter	Symbol	Ratings	Unit
Power Supply Voltage	V _{DD}	-0.1~+4.5 ^{※3}	V
Output Current	I _{OUT}	±0.5	mA
Power Dissipation	P _d	2049 ^{※4}	mW
Operating Temperature Range	T _{opr}	-40~+85	°C
Storage Temperature Range	T _{stg}	-40~+125	°C

※3. Not to exceed P_d

※4. Reduced by 5.36mW for each increase in Ta of 1°C over 25°C (mounted on 70mm × 70mm × 1.6mm Glass-epoxy PCB)

BU52012HFV, BU52013HFV (Ta=25°C)

Parameter	Symbol	Ratings	Unit
Power Supply Voltage	V _{DD}	-0.1~+4.5 ^{※5}	V
Output Current	I _{OUT}	±0.5	mA
Power Dissipation	P _d	536 ^{※6}	mW
Operating Temperature Range	T _{opr}	-40~+85	°C
Storage Temperature Range	T _{stg}	-40~+125	°C

※5. Not to exceed P_d

※6. Reduced by 5.36mW for each increase in Ta of 1°C over 25°C (mounted on 70mm × 70mm × 1.6mm Glass-epoxy PCB)

● Magnetic, Electrical characteristics

BU52002GUL (Unless otherwise specified, V_{DD}=3.0V, Ta=25°C)

Parameter	Symbol	Limits			Unit	Conditions
		Min.	Typ.	Max.		
Power Supply Voltage	V _{DD}	2.4	3.0	3.3	V	
Operate Point	B _{opS}	-	3.7	5.5	mT	
Release Point	B _{rpS}	0.8	2.9	-	mT	
Hysteresis	B _{hysS}	-	0.8	-	mT	
Period	T _P	-	50	100	ms	
Output High Voltage	V _{OH}	V _{DD} -0.4	-	-	V	B < B _{rpS} I _{OUT} = -1.0mA ^{※7}
Output Low Voltage	V _{OL}	-	-	0.4	V	B _{opS} < B I _{OUT} = +1.0mA ^{※7}
Supply Current	I _{DD(AVG)}	-	6.5	9	μA	Average
Supply Current During Startup Time	I _{DD(EN)}	-	4.7	-	mA	During Startup Time Value
Supply Current During Standby Time	I _{DD(DIS)}	-	3.8	-	μA	During Standby Time Value

※7. B = Magnetic flux density
1mT=10Gauss

Positive (“+”) polarity flux is defined as the magnetic flux from south pole which is direct toward to the branded face of the sensor.

After applying power supply, it takes one cycle of period (T_P) to become definite output.

Radiation hardness is not designed.

BU52003GUL (Unless otherwise specified, $V_{DD}=3.0V$, $T_a=25^{\circ}C$)

Parameter	Symbol	Limits			Unit	Conditions
		Min.	Typ.	Max.		
Power Supply Voltage	V_{DD}	2.4	3.0	3.3	V	
Operate Point	B_{opN}	-5.5	-3.7	-	mT	
Release Point	B_{rpN}	-	-2.9	-0.8	mT	
Hysteresis	B_{hysN}	-	0.8	-	mT	
Period	T_P	-	50	100	ms	
Output High Voltage	V_{OH}	$V_{DD}-0.4$	-	-	V	$B_{rpN} < B$ $I_{OUT} = -1.0mA$ ※8
Output Low Voltage	V_{OL}	-	-	0.4	V	$B < B_{opN}$ $I_{OUT} = +1.0mA$ ※8
Supply Current	$I_{DD(AVG)}$	-	6.5	9	μA	Average
Supply Current During Startup Time	$I_{DD(EN)}$	-	4.7	-	mA	During Startup Time Value
Supply Current During Standby Time	$I_{DD(DIS)}$	-	3.8	-	μA	During Standby Time Value

※8. B = Magnetic flux density
1mT=10Gauss

Positive (“+”) polarity flux is defined as the magnetic flux from south pole which is direct toward to the branded face of the sensor.

After applying power supply, it takes one cycle of period (T_P) to become definite output.

Radiation hardiness is not designed.

BU52012NVX (Unless otherwise specified, $V_{DD}=1.80V$, $T_a=25^{\circ}C$)

Parameter	Symbol	Limits			Unit	Conditions
		Min.	Typ.	Max.		
Power Supply Voltage	V_{DD}	1.65	1.80	3.60	V	
Operate Point	B_{opS}	-	3.0	5.0	mT	
Release Point	B_{rpS}	0.6	2.1	-	mT	
Hysteresis	B_{hysS}	-	0.9	-	mT	
Period	T_P	-	50	100	ms	
Output High Voltage	V_{OH}	$V_{DD}-0.2$	-	-	V	$B < B_{rpS}$ $I_{OUT} = -0.5mA$ ※9
Output Low Voltage	V_{OL}	-	-	0.2	V	$B_{opS} < B$ $I_{OUT} = +0.5mA$ ※9
Supply Current 1	$I_{DD1(AVG)}$	-	3.5	5.5	μA	$V_{DD}=1.8V$, Average
Supply Current During Startup Time 1	$I_{DD1(EN)}$	-	2.8	-	mA	$V_{DD}=1.8V$, During Startup Time Value
Supply Current During Standby Time 1	$I_{DD1(DIS)}$	-	1.8	-	μA	$V_{DD}=1.8V$, During Standby Time Value
Supply Current 2	$I_{DD2(AVG)}$	-	8.0	12.5	μA	$V_{DD}=3.0V$, Average
Supply Current During Startup Time 2	$I_{DD2(EN)}$	-	5.3	-	mA	$V_{DD}=3.0V$, During Startup Time Value
Supply Current During Standby Time 2	$I_{DD2(DIS)}$	-	5.2	-	μA	$V_{DD}=3.0V$, During Standby Time Value

※9. B = Magnetic flux density

1mT=10Gauss

Positive (“+”) polarity flux is defined as the magnetic flux from south pole which is direct toward to the branded face of the sensor.

After applying power supply, it takes one cycle of period (T_P) to become definite output.

Radiation hardness is not designed.

BU52012HFV (Unless otherwise specified, $V_{DD}=1.80V$, $T_a=25^{\circ}C$)

Parameter	Symbol	Limits			Unit	Conditions
		Min.	Typ.	Max.		
Power Supply Voltage	V_{DD}	1.65	1.80	3.30	V	
Operate Point	B_{opS}	-	3.0	5.0	mT	
Release Point	B_{rpS}	0.6	2.1	-	mT	
Hysteresis	B_{hysS}	-	0.9	-	mT	
Period	T_P	-	50	100	ms	
Output High Voltage	V_{OH}	$V_{DD}-0.2$	-	-	V	$B < B_{rpS}$ $I_{OUT} = -0.5mA$ ※10
Output Low Voltage	V_{OL}	-	-	0.2	V	$B_{opS} < B$ $I_{OUT} = +0.5mA$ ※10
Supply Current 1	$I_{DD1(AVG)}$	-	3.5	5.5	μA	$V_{DD}=1.8V$, Average
Supply Current During Startup Time 1	$I_{DD1(EN)}$	-	2.8	-	mA	$V_{DD}=1.8V$, During Startup Time Value
Supply Current During Standby Time 1	$I_{DD1(DIS)}$	-	1.8	-	μA	$V_{DD}=1.8V$, During Standby Time Value
Supply Current 2	$I_{DD2(AVG)}$	-	6.5	9	μA	$V_{DD}=2.7V$, Average
Supply Current During Startup Time 2	$I_{DD2(EN)}$	-	4.5	-	mA	$V_{DD}=2.7V$, During Startup Time Value
Supply Current During Standby Time 2	$I_{DD2(DIS)}$	-	4.0	-	μA	$V_{DD}=2.7V$, During Standby Time Value

※10. B = Magnetic flux density

1mT=10Gauss

Positive (“+”) polarity flux is defined as the magnetic flux from south pole which is direct toward to the branded face of the sensor.

After applying power supply, it takes one cycle of period (T_P) to become definite output.

Radiation hardness is not designed.

BU52013HFV (Unless otherwise specified, $V_{DD}=1.80V$, $T_a=25^{\circ}C$)

Parameter	Symbol	Limits			Unit	Conditions
		Min.	Typ.	Max.		
Power Supply Voltage	V_{DD}	1.65	1.80	3.30	V	
Operate Point	B_{opN}	-5.0	-3.0	-	mT	
Release Point	B_{rpN}	-	-2.1	-0.6	mT	
Hysteresis	B_{hysN}	-	0.9	-	mT	
Period	T_P	-	50	100	ms	
Output High Voltage	V_{OH}	V_{DD} -0.2	-	-	V	$B_{rpN} < B$ $I_{OUT} = -0.5mA$ ※11
Output Low Voltage	V_{OL}	-	-	0.2	V	$B < B_{opN}$ $I_{OUT} = +0.5mA$ ※11
Supply Current 1	$I_{DD1(AVG)}$	-	3.5	5.5	μA	$V_{DD}=1.8V$, Average
Supply Current During Startup Time 1	$I_{DD1(EN)}$	-	2.8	-	mA	$V_{DD}=1.8V$, During Startup Time Value
Supply Current During Standby Time 1	$I_{DD1(DIS)}$	-	1.8	-	μA	$V_{DD}=1.8V$, During Standby Time Value
Supply Current 2	$I_{DD2(AVG)}$	-	6.5	9	μA	$V_{DD}=2.7V$, Average
Supply Current During Startup Time 2	$I_{DD2(EN)}$	-	4.5	-	mA	$V_{DD}=2.7V$, During Startup Time Value
Supply Current During Standby Time 2	$I_{DD2(DIS)}$	-	4.0	-	μA	$V_{DD}=2.7V$, During Standby Time Value

※11. B = Magnetic flux density

1mT=10Gauss

Positive (“+”) polarity flux is defined as the magnetic flux from south pole which is direct toward to the branded face of the sensor.

After applying power supply, it takes one cycle of period (T_P) to become definite output.

Radiation hardness is not designed.

●Figure of measurement circuit

B_{op}/B_{rp}



Bop and Brp are measured with applying the magnetic field from the outside.

Fig.1 B_{op},B_{rp} measurement circuit

T_p



The period is monitored by Oscilloscope.

Fig.2 T_p measurement circuit

V_{OH}



Fig.3 V_{OH} measurement circuit

Product Name	I _{OUT}
BU52002GUL, BU52003GUL	1.0mA
BU52012NVX, BU52012HFV, BU52013HFV	0.5mA

V_{OL}

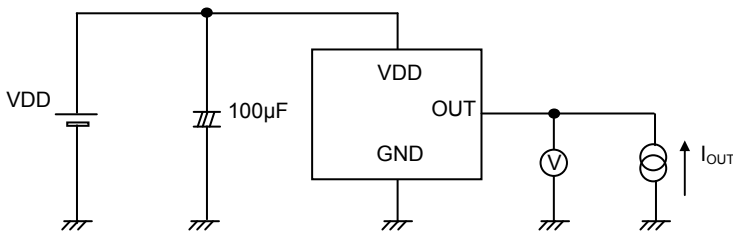


Fig.4 V_{OL} measurement circuit

Product Name	I _{OUT}
BU52002GUL, BU52003GUL	1.0mA
BU52012NVX, BU52012HFV, BU52013HFV	0.5mA

I_{DD}

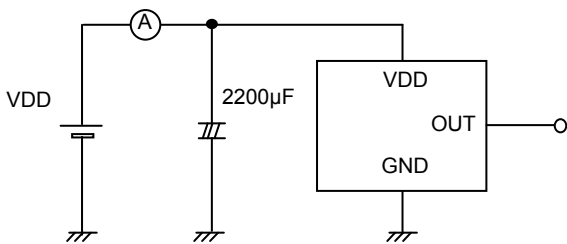


Fig.5 I_{DD} measurement circuit

● Technical (Reference) Data

BU52002GUL (V_{DD}=2.4~3.3V type)

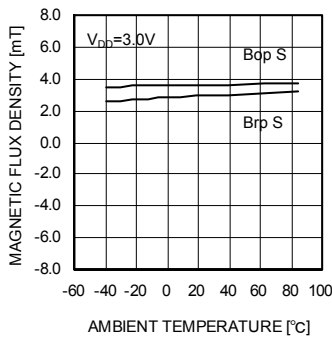


Fig. 6 Bop, Brp – Ambient temperature

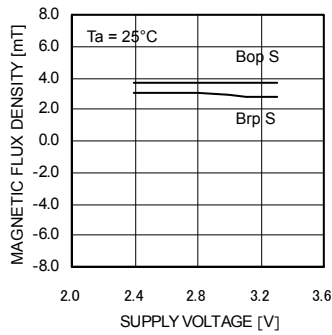


Fig. 7 Bop, Brp – Supply voltage

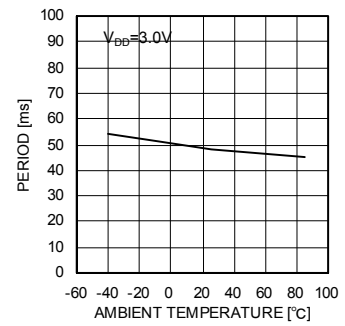


Fig. 8 T_P – Ambient temperature

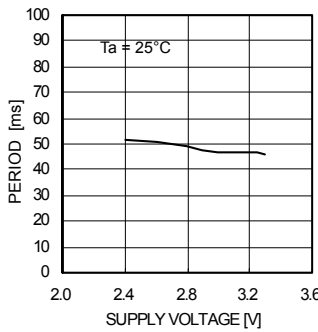


Fig. 9 T_P – Supply voltage

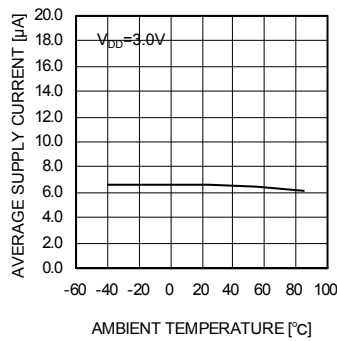


Fig. 10 I_{DD} – Ambient temperature

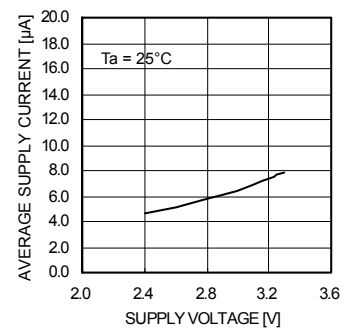


Fig. 11 I_{DD} – Supply voltage

BU52003GUL (V_{DD}=2.4~3.3V type)

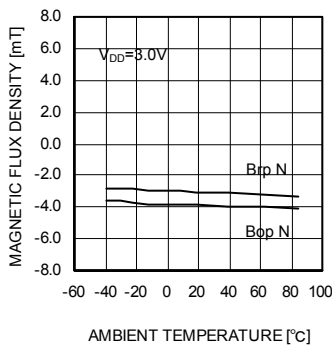


Fig. 12 Bop, Brp – Ambient temperature



Fig. 13 Bop, Brp – Supply voltage



Fig. 14 T_P – Ambient temperature

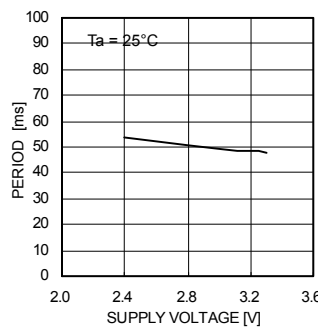


Fig. 15 T_P – Supply voltage



Fig. 16 I_{DD} – Ambient temperature



Fig. 17 I_{DD} – Supply voltage

BU52012NVX (V_{DD}=1.65~3.6V type)

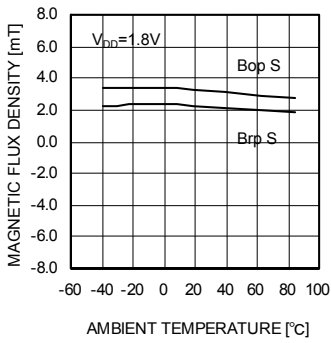


Fig.18 Bop,Brp – Ambient temperature



Fig.19 Bop,Brp – Supply voltage



Fig.20 T_P – Ambient temperature

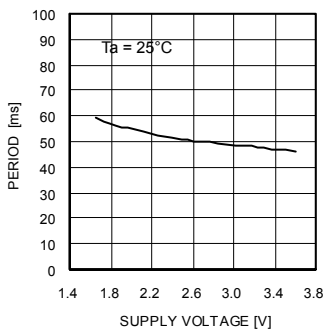


Fig.21 T_P – Supply voltage

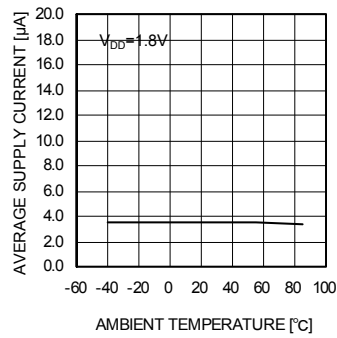


Fig.22 I_{DD} – Ambient temperature

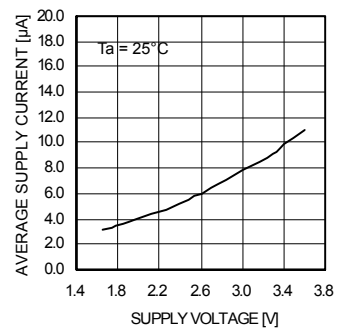


Fig.23 I_{DD} – Supply voltage

BU52012HFV (V_{DD}=1.65~3.3V type)

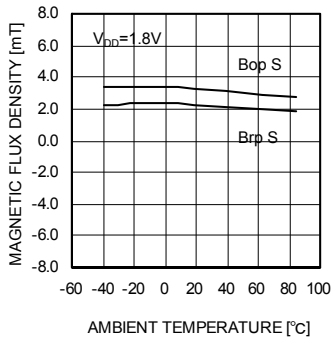


Fig.24 Bop,Brp – Ambient temperature

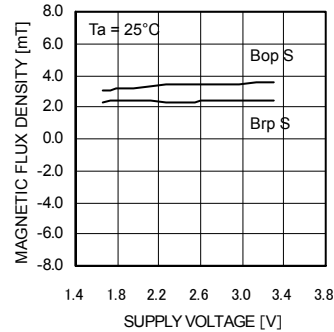


Fig.25 Bop,Brp – Supply voltage

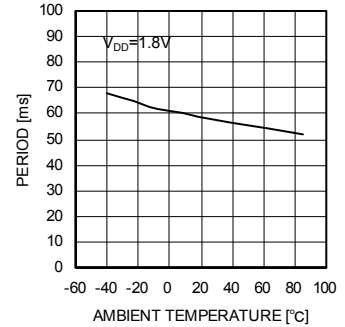


Fig.26 T_P – Ambient temperature

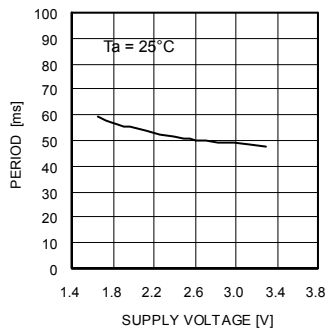


Fig.27 T_P – Supply voltage

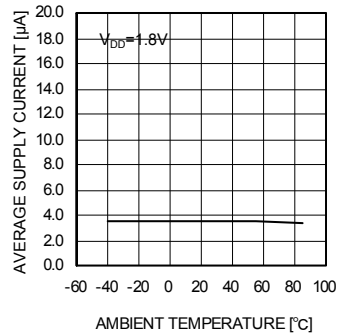


Fig.28 I_{DD} – Ambient temperature

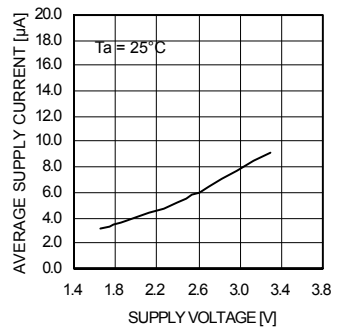


Fig.29 I_{DD} – Supply voltage

BU52013HFV (V_{DD}=1.65~3.3V type)

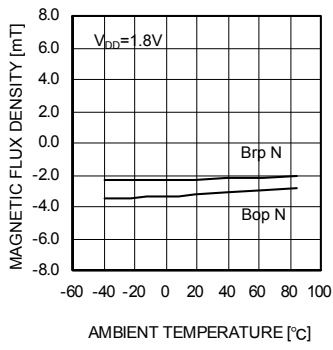


Fig.30 Bop,Brp – Ambient temperature

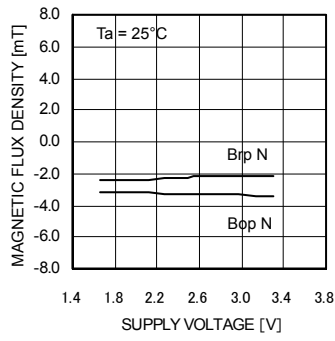


Fig.31 Bop,Brp – Supply voltage

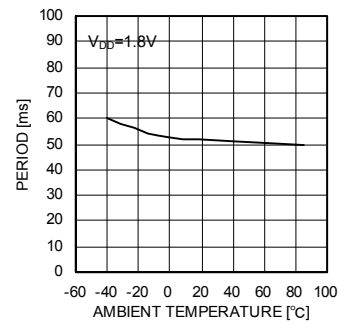


Fig.32 T_P – Ambient temperature

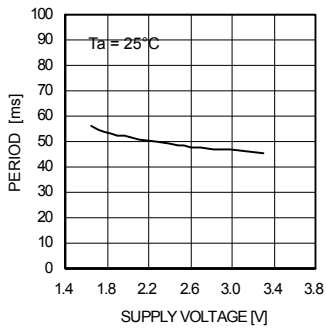


Fig.33 T_P – Supply voltage

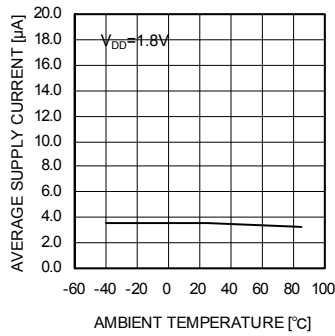


Fig.34 I_{DD} – Ambient temperature

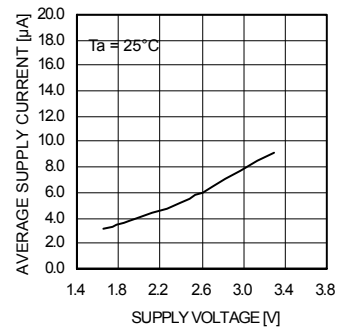


Fig.35 I_{DD} – Supply voltage

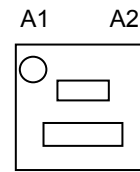
●Block Diagram

BU52002GUL, BU52003GUL

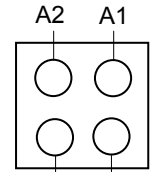


Fig.36

PIN No.	PIN NAME	FUNCTION	COMMENT
A1	VDD	POWER SUPPLY	
A2	GND	GROUND	
B1	OUT	OUTPUT	
B2	N.C.		OPEN or Short to GND.



Surface



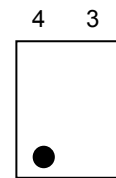
Reverse

BU52012NVX

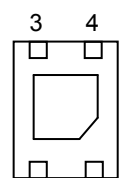


Fig.37

PIN No.	PIN NAME	FUNCTION	COMMENT
1	OUT	OUTPUT	
2	GND	GROUND	
3	N.C.		OPEN or Short to GND.
4	VDD	POWER SUPPLY	



Surface



Reverse

BU52012HFV, BU52013HFV



Fig.38

PIN No.	PIN NAME	FUNCTION	COMMENT
1	N.C.		OPEN or Short to GND.
2	GND	GROUND	
3	N.C.		OPEN or Short to GND.
4	VDD	POWER SUPPLY	
5	OUT	OUTPUT	



●Description of Operations
(Micropower Operation)



Fig.39

The unipolar detection Hall IC adopts an intermittent operation method to save energy. At startup, the Hall elements, amp, comparator and other detection circuit power ON and magnetic detection begins. During standby, the detection circuits power OFF, thereby reducing current consumption. The detection results are held while standby is active, and then output.

Reference period: 50ms (MAX100ms)
Reference startup time: 24µs

(Offset Cancellation)



Fig.40

The Hall elements form an equivalent Wheatstone (resistor) bridge circuit. Offset voltage may be generated by a differential in this bridge resistance, or can arise from changes in resistance due to package or bonding stress. A dynamic offset cancellation circuit is employed to cancel this offset voltage. When Hall elements are connected as shown in Fig. 40 and a magnetic field is applied perpendicular to the Hall elements, voltage is generated at the mid-point terminal of the bridge. This is known as Hall voltage. Dynamic cancellation switches the wiring (shown in the figure) to redirect the current flow to a 90° angle from its original path, and thereby cancels the Hall voltage. The magnetic signal (only) is maintained in the sample/hold circuit during the offset cancellation process and then released.

(Magnetic Field Detection Mechanism)



Fig.41

The Hall IC cannot detect magnetic fields that run horizontal to the package top layer.
 Be certain to configure the Hall IC so that the magnetic field is perpendicular to the top layer.

BU52002GUL, BU52012HFV

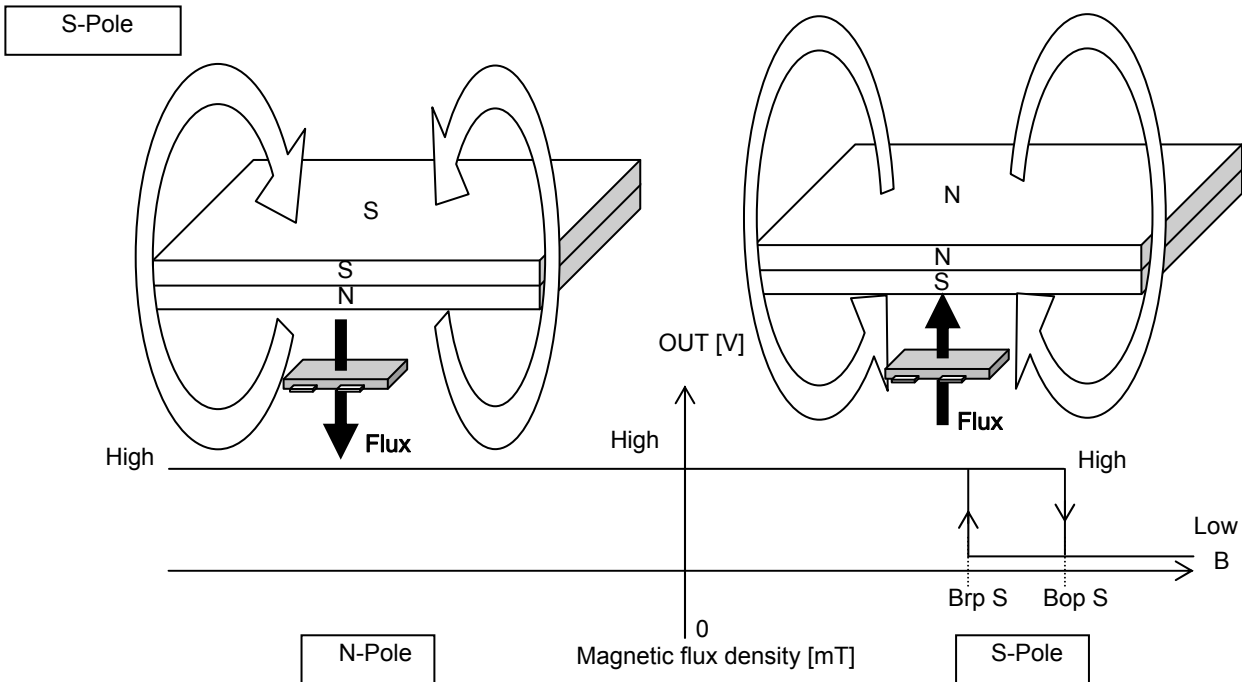


Fig.42 S-Pole Detection

BU52002GUL, BU52012HFV detects and outputs for the S-pole only. Since it is unipolar, it does not recognize the N-pole.

BU52003GUL, BU52013HFV

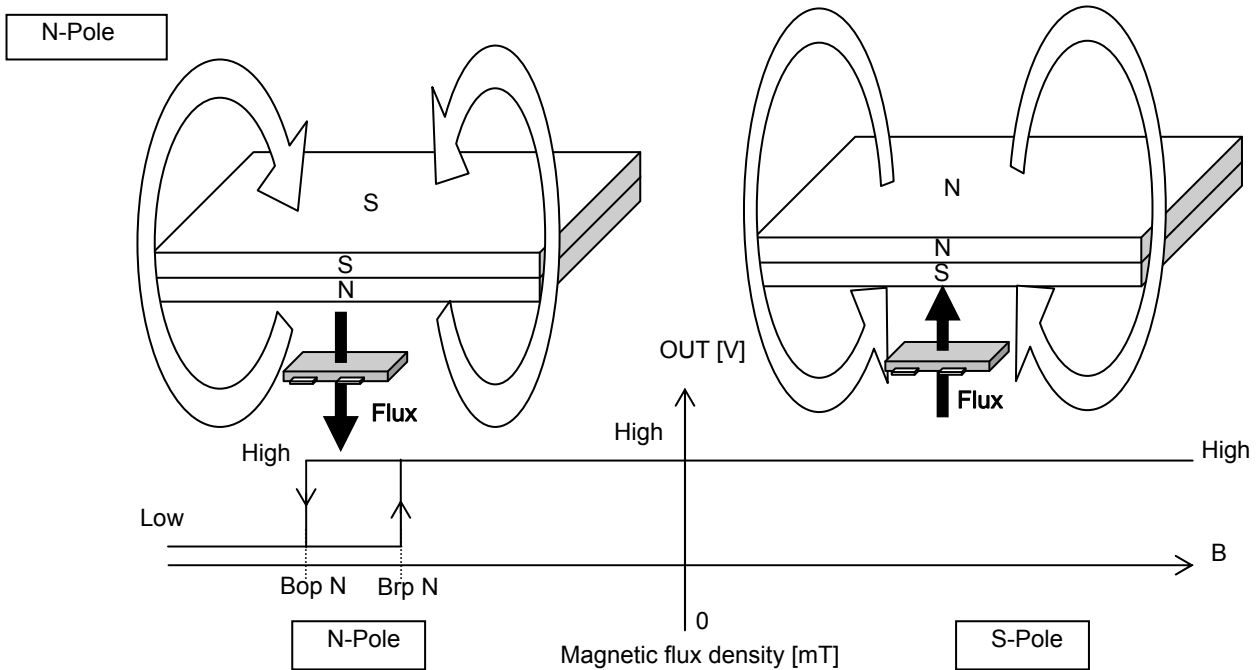


Fig.43 N-Pole Detection

BU52003GUL, BU52013HFV detects and outputs for the N-pole only. Since it is unipolar, it does not recognize the S-pole.

The unipolar detection Hall IC detects magnetic fields running perpendicular to the top surface of the package. There is an inverse relationship between magnetic flux density and the distance separating the magnet and the Hall IC: when distance increases magnetic density falls. When it drops below the operate point (Bop), output goes HIGH. When the magnet gets closer to the IC and magnetic density rises, to the operate point, the output switches LOW. In LOW output mode, the distance from the magnet to the IC increases again until the magnetic density falls to a point just below Bop, and output returns HIGH. (This point, where magnetic flux density restores HIGH output, is known as the release point, Brp.) This detection and adjustment mechanism is designed to prevent noise, oscillation and other erratic system operation.

● Intermittent Operation at Power ON

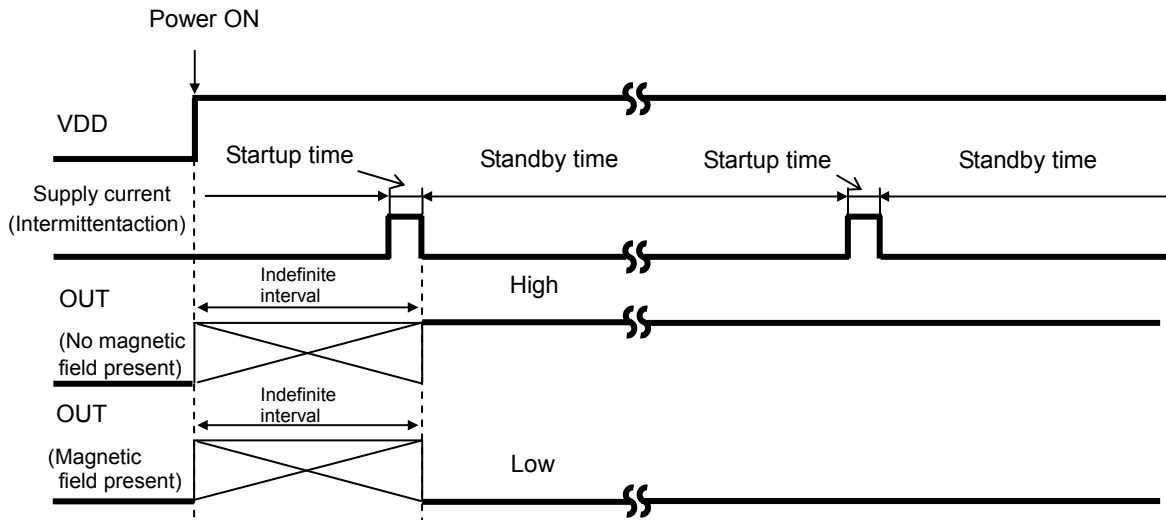


Fig.44

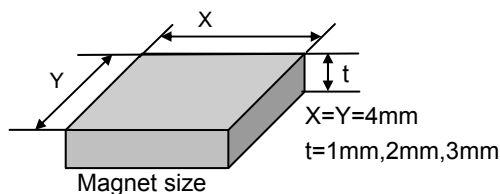
The unipolar detection Hall IC adopts an intermittent operation method in detecting the magnetic field during startup, as shown in Fig.44. It outputs to the appropriate terminal based on the detection result and maintains the output condition during the standby period. The time from power ON until the end of the initial startup period is an indefinite interval, but it cannot exceed the maximum period, 100ms. To accommodate the system design, the Hall IC output read should be programmed within 100ms of power ON, but after the time allowed for the period ambient temperature and supply voltage.

● Magnet Selection

Of the two representative varieties of permanent magnet, neodymium generally offers greater magnetic power per volume than ferrite, thereby enabling the highest degree of miniaturization, thus, neodymium is best suited for small equipment applications. Fig.45 shows the relation between the size (volume) of a neodymium magnet and magnetic flux density. The graph plots the correlation between the distance (L) from three versions of a 4mm X 4mm cross-section neodymium magnet (1mm, 2mm, and 3mm thick) and magnetic flux density. Fig.46 shows Hall IC detection distance – a good guide for determining the proper size and detection distance of the magnet. Based on the BU52012HFV, BU52013HFV operating point max 5.0 mT, the minimum detection distance for the 1mm, 2mm and 3mm magnets would be 7.6mm, 9.22mm, and 10.4mm, respectively. To increase the magnet's detection distance, either increase its thickness or sectional area.



Fig.45

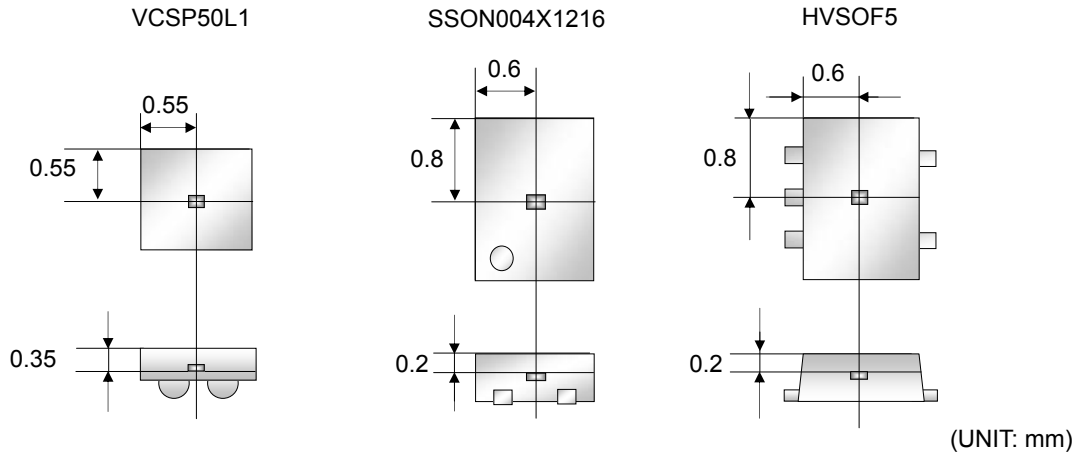


Magnet material: NEOMAX-44H (material)
 Maker: NEOMAX CO.,LTD.



Fig.46 Magnet Dimensions and Flux Density Measuring Point

●Position of the Hall effect IC(Reference)



●Footprint dimensions (Optimize footprint dimensions to the board design and soldering condition)

VCSP50L1

Symbol	Reference Value
e	0.50
b3	0.25
SD	0.25
SE	0.25

SSON004X1216

Please avoid having potential overstress from PCB material, strength, mounting positions. If you had any further questions or concerns, please contact your Rohm sales and affiliate.

HVSO5

(UNIT: mm)

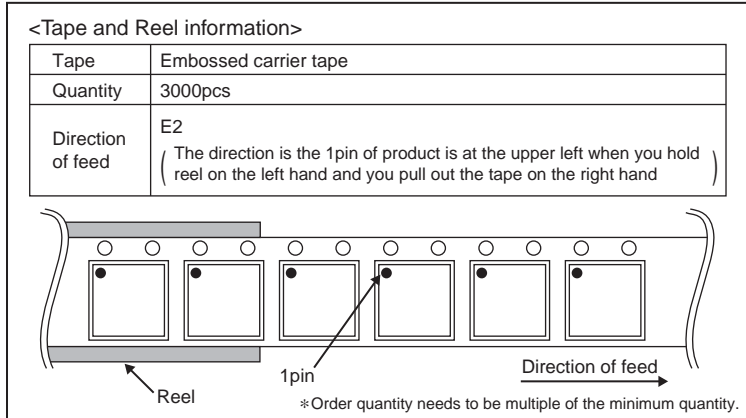
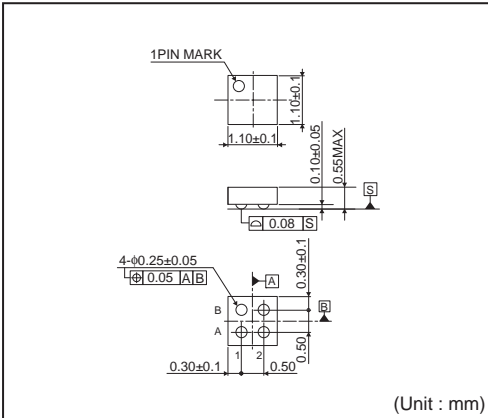
● Operation Notes

- 1) Absolute maximum ratings
Exceeding the absolute maximum ratings for supply voltage, operating conditions, etc. may result in damage to or destruction of the IC. Because the source (short mode or open mode) cannot be identified if the device is damaged in this way, it is important to take physical safety measures such as fusing when implementing any special mode that operates in excess of absolute rating limits.
- 2) GND voltage
Make sure that the GND terminal potential is maintained at the minimum in any operating state, and is always kept lower than the potential of all other pins.
- 3) Thermal design
Use a thermal design that allows for sufficient margin in light of the power dissipation (Pd) in actual operating conditions.
- 4) Pin shorts and mounting errors
Use caution when positioning the IC for mounting on printed circuit boards. Mounting errors, such as improper positioning or orientation, may damage or destroy the device. The IC may also be damaged or destroyed if output pins are shorted together, or if shorts occur between the output pin and supply pin or GND.
- 5) Positioning components in proximity to the Hall IC and magnet
Positioning magnetic components in close proximity to the Hall IC or magnet may alter the magnetic field, and therefore the magnetic detection operation. Thus, placing magnetic components near the Hall IC and magnet should be avoided in the design if possible. However, where there is no alternative to employing such a design, be sure to thoroughly test and evaluate performance with the magnetic component(s) in place to verify normal operation before implementing the design.
- 6) Operation in strong electromagnetic fields
Exercise extreme caution about using the device in the presence of a strong electromagnetic field, as such use may cause the IC to malfunction.
- 7) Common impedance
Make sure that the power supply and GND wiring limits common impedance to the extent possible by, for example, employing short, thick supply and ground lines. Also, take measures to minimize ripple such as using an inductor or capacitor.
- 8) GND wiring pattern
When both a small-signal GND and high-current GND are provided, single-point grounding at the reference point of the set PCB is recommended, in order to separate the small-signal and high-current patterns, and to ensure that voltage changes due to the wiring resistance and high current do not cause any voltage fluctuation in the small-signal GND. In the same way, care must also be taken to avoid wiring pattern fluctuations in the GND wiring pattern of external components.
- 9) Exposure to strong light
Exposure to halogen lamps, UV and other strong light sources may cause the IC to malfunction. If the IC is subject to such exposure, provide a shield or take other measures to protect it from the light. In testing, exposure to white LED and fluorescent light sources was shown to have no significant effect on the IC.
- 10) Power source design
Since the IC performs intermittent operation, it has peak current when it's ON. Please taking that into account and under examine adequate evaluations when designing the power source.

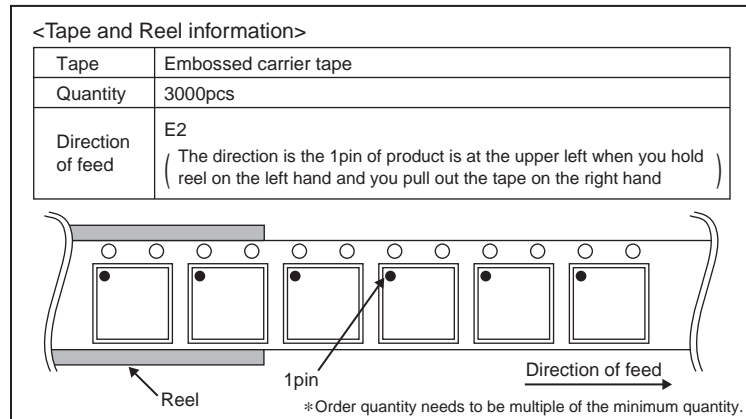
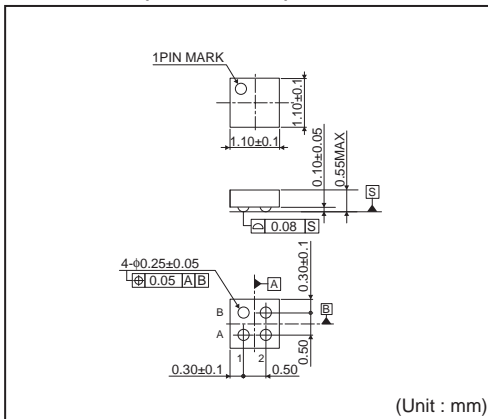
● Ordering part number

B	U	5	2	0	0	2	G	U	L	-	E	2
Part No.		Part No. 52002, 52003, 52012, 52013					Package GUL : VSCP50L1 HFV : HVSO5 NVX : SSON004X1216			Packaging and forming specification E2: Embossed tape and reel (VSCP50L1) TR: Embossed tape and reel (HVSO5, SSON004X1216)		

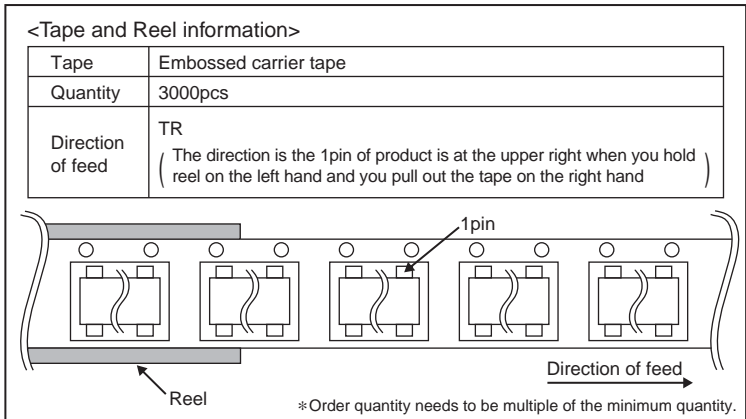
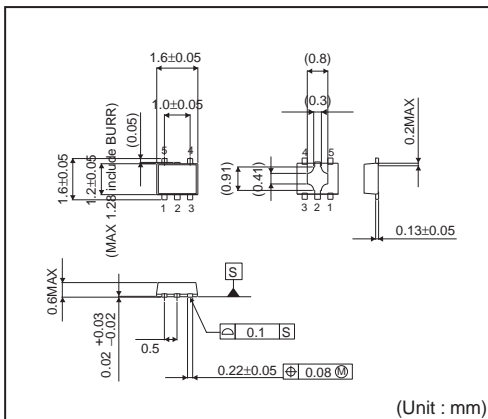
VCSP50L1 (BU52002GUL)



VCSP50L1 (BU52003GUL)



HVSO5

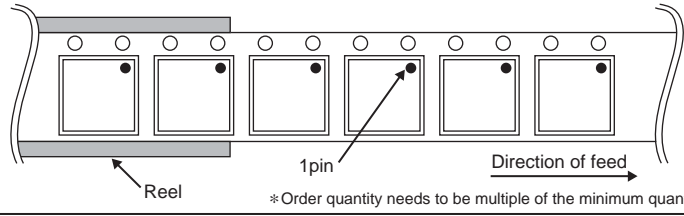


SSON004X1216



<Tape and Reel information>

Tape	Embossed carrier tape
Quantity	5000pcs
Direction of feed	TR (The direction is the 1 pin of product is at the upper right when you hold reel on the left hand and you pull out the tape on the right hand)



Notes

No copying or reproduction of this document, in part or in whole, is permitted without the consent of ROHM Co.,Ltd.

The content specified herein is subject to change for improvement without notice.

The content specified herein is for the purpose of introducing ROHM's products (hereinafter "Products"). If you wish to use any such Product, please be sure to refer to the specifications, which can be obtained from ROHM upon request.

Examples of application circuits, circuit constants and any other information contained herein illustrate the standard usage and operations of the Products. The peripheral conditions must be taken into account when designing circuits for mass production.

Great care was taken in ensuring the accuracy of the information specified in this document. However, should you incur any damage arising from any inaccuracy or misprint of such information, ROHM shall bear no responsibility for such damage.

The technical information specified herein is intended only to show the typical functions of and examples of application circuits for the Products. ROHM does not grant you, explicitly or implicitly, any license to use or exercise intellectual property or other rights held by ROHM and other parties. ROHM shall bear no responsibility whatsoever for any dispute arising from the use of such technical information.

The Products specified in this document are intended to be used with general-use electronic equipment or devices (such as audio visual equipment, office-automation equipment, communication devices, electronic appliances and amusement devices).

The Products specified in this document are not designed to be radiation tolerant.

While ROHM always makes efforts to enhance the quality and reliability of its Products, a Product may fail or malfunction for a variety of reasons.

Please be sure to implement in your equipment using the Products safety measures to guard against the possibility of physical injury, fire or any other damage caused in the event of the failure of any Product, such as derating, redundancy, fire control and fail-safe designs. ROHM shall bear no responsibility whatsoever for your use of any Product outside of the prescribed scope or not in accordance with the instruction manual.

The Products are not designed or manufactured to be used with any equipment, device or system which requires an extremely high level of reliability the failure or malfunction of which may result in a direct threat to human life or create a risk of human injury (such as a medical instrument, transportation equipment, aerospace machinery, nuclear-reactor controller, fuel-controller or other safety device). ROHM shall bear no responsibility in any way for use of any of the Products for the above special purposes. If a Product is intended to be used for any such special purpose, please contact a ROHM sales representative before purchasing.

If you intend to export or ship overseas any Product or technology specified herein that may be controlled under the Foreign Exchange and the Foreign Trade Law, you will be required to obtain a license or permit under the Law.



Thank you for your accessing to ROHM product informations.
More detail product informations and catalogs are available, please contact us.

ROHM Customer Support System

<http://www.rohm.com/contact/>

Mouser Electronics

Authorized Distributor

Click to View Pricing, Inventory, Delivery & Lifecycle Information:

[ROHM Semiconductor:](#)

[BU52013HFV-TR](#)