

ATS625 Preliminary

True Zero Speed, Low Jitter, High Accuracy, Gear Tooth Sensor

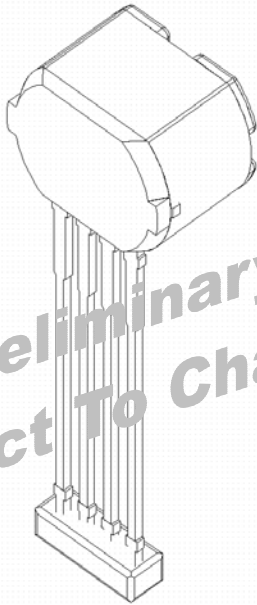

Preliminary
Subject To Change

Pin 1: V_{CC}
Pin 2: V_{OUT}
Pin 3: Gnd (recommended) or Float
Pin 4: Gnd

ABSOLUTE MAXIMUM RATINGS

Supply Voltage ¹ ,	
V_{CC}	26.5 V
Reverse Supply Voltage,	
V_R	-18 V
Reverse Supply Current,	
I_R	50 mA
Reverse Output Voltage,	
V_{ORout}	-0.5 V
Continuous Output Current,	
I_{OUT}	25 mA
Operating Temperature Range,	
T_{OP}	-40° C to 150° C
Storage Temperature,	
T_S	170° C
Package Power Rating,	
θ_{JA}	126° C/W
Maximum Junction Temperature,	
T_{Jmax}	165° C
Maximum Junction Temperature – 100 Hours,	
T_{Jmax}	180° C

¹ Refer to power de-rating curve

The ATS625 true zero speed gear tooth sensor is an optimized Hall IC/magnet configuration packaged in a molded module that provides a user-friendly solution for digital gear tooth sensing applications. The sensor assembly consists of an over-molded package, which holds together a samarium cobalt magnet, a pole piece and a true zero-speed Hall IC that has been optimized to the magnetic circuit. This small package can be easily assembled and used in conjunction with gears of various shapes and sizes.

The sensor incorporates a dual element Hall IC that switches in response to differential magnetic signals created by a ferrous target. Digital processing of the analog signal provides zero speed performance independent of air gap and also dynamic adaptation of device performance to the typical operating conditions found in automotive applications (reduced vibration sensitivity). High-resolution peak detecting DACs are used to set the adaptive switching thresholds of the device. Hysteresis in the thresholds reduces the negative effects of any anomalies in the magnetic signal associated with the targets used in many automotive applications.

This sensor system is optimized for crank applications that utilize targets that possess signature regions.

When ordering, please use the complete part number: ATS625LSG.

FEATURES & BENEFITS

- ♦ Highly repeatable over temperature
- ♦ Tight timing accuracy over temperature
- ♦ True zero speed operation
- ♦ Air gap independent switch points
- ♦ Large operating air gaps
- ♦ Defined power up state
- ♦ Wide operating voltage range
- ♦ Digital output representing target profile
- ♦ Single chip sensing IC for high reliability
- ♦ Small mechanical size
- ♦ Optimized Hall IC magnetic system
- ♦ Fast start-up
- ♦ AGC and continuous update circuit
- ♦ Under-voltage lockout
- ♦ Improved resistance to transients coupled onto the output

ATS625 PRELIMINARY

OPERATING CHARACTERISTICS

Valid at $T_a = -40^{\circ}\text{C}$ to 150°C ($T_j \leq T_{jmax}$) over air gap unless otherwise noted.

Typical operating parameters: $V_{cc} = 12\text{ V}$ and 25°C ambient temperature.

Characteristic	Symbol	Test Conditions	Min.	Typ.	Max.	Units
ELECTRICAL CHARACTERISTICS						
Supply Voltage	V_{CC}	Operating; $T_j < T_{jmax}$	4.0		24	V
Under Voltage Lockout	UVLO				$< V_{CC\ min}$	V
Reverse Supply Current	I_{RCC}	$V_{CC} = -18\text{ V}$			-10	mA
Supply Zener Clamp Voltage	V_Z		26.5	32	38	V
Supply Zener Current	I_Z	$T_j < T_j(max)$; Continuous		100		mA
Supply Current	I_{CC}	Output OFF		9	14	mA
		Output ON		9	14	mA
POWER-ON STATE CHARACTERISTICS						
Power-On State	S_{PO}			High		
Power Up Time	t_{PO}	Gear Speed $< 100\text{ RPM}$; $V_{CC} > V_{CC\ min}$			200	us
OUTPUT STAGE						
Low Output Voltage	V_{Sat}	$I_{SINK} = 20\text{ mA}$, Output = ON		200	400	mV
Output Current Limit	I_{lin}	$V_{OUT} = 12\text{ V}$, $T_j < T_j(max)$	25	45	70	mA
Output Leakage Current	I_{OFF}	Output = OFF, $V_{OUT} = 24\text{ V}$			10	μA
Output Rise Time	t_r	$R_L = 500\ \Omega$, $C_L = 10\text{ pF}$		1.0	2	μs
Output Fall Time	t_f	$R_L = 500\ \Omega$, $C_L = 10\text{ pF}$		0.6	2	μs
SWITCH POINT CHARACTERISTICS						
Minimum Speed	S_{min}		0			rpm
Maximum Speed	S_{max}	Reference target			12000	rpm
Bandwidth	f-3db			20		kHz
Operate Point	Bop%	% of peak-to-peak signal, $AG < AG_{max}$; Output High to Low		60		%
Release Point	Brp%	% of peak-to-peak signal, $AG < AG_{max}$; Output Low to High		40		%
CALIBRATION						
Initial Calibration		Start-up ²		1	6	edges
Calibration Update		Running mode operation		continuous		

² Power-up speed $\leq 200\text{ rpm}$. Refer to Applications section for description of start-up behavior.

ATS625 PRELIMINARY

Characteristic	Symbol	Test Conditions	Min.	Typ.	Max.	Units
OPERATING CHARACTERISTICS (with 60+0 reference target)						
Operational Air Gap	AG	Measured from sensor face to target	0.5	-	2.5	mm
Relative Timing Accuracy, Sequential Mechanical Rising Edge		Operational air gap, constant speed, relative to position at 1.5 mm	-	-	± 0.4	°
Relative Timing Accuracy, Sequential Mechanical Falling Edge		Operational air gap, constant speed, relative to position at 1.5 mm	-	-	± 0.4	°
Relative Timing Accuracy, Signature Mechanical Rising Edge		Operational air gap, constant speed, relative to position at 1.5 mm	-	-	± 0.4	°
Relative Timing Accuracy, Signature Mechanical Falling Edge		Operational air gap, constant speed, relative to position at 1.5 mm	-	-	± 1.5 ³	°
Relative Repeatability ⁴ , Sequential Rising and Falling Edges	T _{θE}	360° Repeatability, 1000 edges; peak-peak sinusoidal signal with 60 G minimum and 6° period	-	-	0.08	°
Operating Signal		Accuracy spec compliance (operational air gap)	60	-	-	G

³ Accuracy on this edge is highly dependent upon specific target geometry; please consult with Allegro Microsystems to aid with assessment of specific target geometries.

⁴ Repeatability specification based on statistical evaluation of sample population.

REFERENCE TARGET/GEAR INFORMATION

Diameter	120	mm
Thickness	6	mm
Sequential Tooth Width	3	mm
Sequential Valley Width	3	mm
Sequential Valley Depth	3	mm
Signature Tooth Width	9	mm
Material	Low carbon steel	

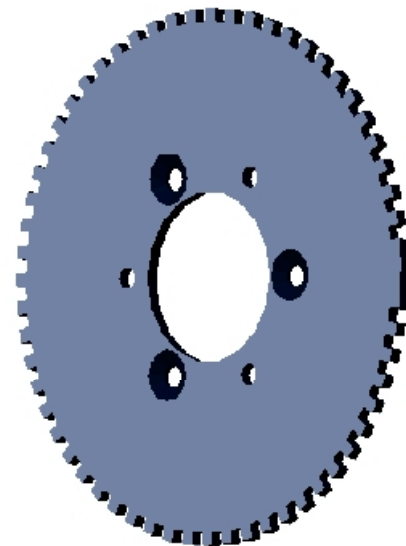

SENSOR DESCRIPTION

Assembly Description:

The ATS625LSG true zero speed gear tooth sensor is a Hall IC/magnet configuration that is fully optimized to provide digital detection of gear tooth edges. This sensor is integrally molded into a plastic body that has been optimized for size, ease of assembly, and manufacturability. High operating temperature materials are used in all aspects of construction.

Sensing Technology:

The gear tooth sensor contains a single-chip differential Hall effect sensor IC, a 4-pin leadframe, a Samarium Cobalt magnet, and a flat ferrous pole piece. The Hall IC consists of two Hall elements spaced 2.2 mm apart that each measure the magnetic gradient created by the passing of a ferrous object. The differential output of the two elements is converted to a digital signal that is processed to provide the digital output.

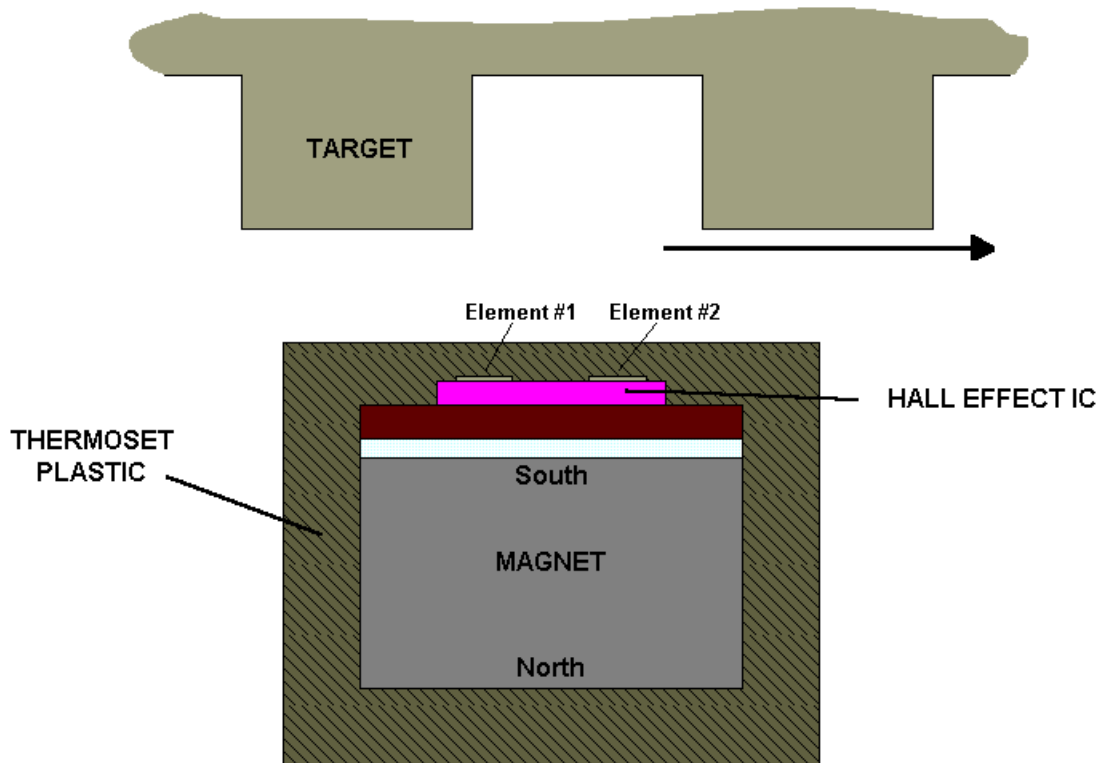

ATS625 PRELIMINARY

Operation:

After proper power is applied to the component the sensor is then capable of providing digital information that is representative of the profile of a rotating gear. No additional optimization is needed and minimal processing circuitry is required. This ease of use should reduce design time and incremental assembly costs for most applications. The following output diagram is indicative of the sensor performance for the polarity indicated in the figure at the bottom of the page.

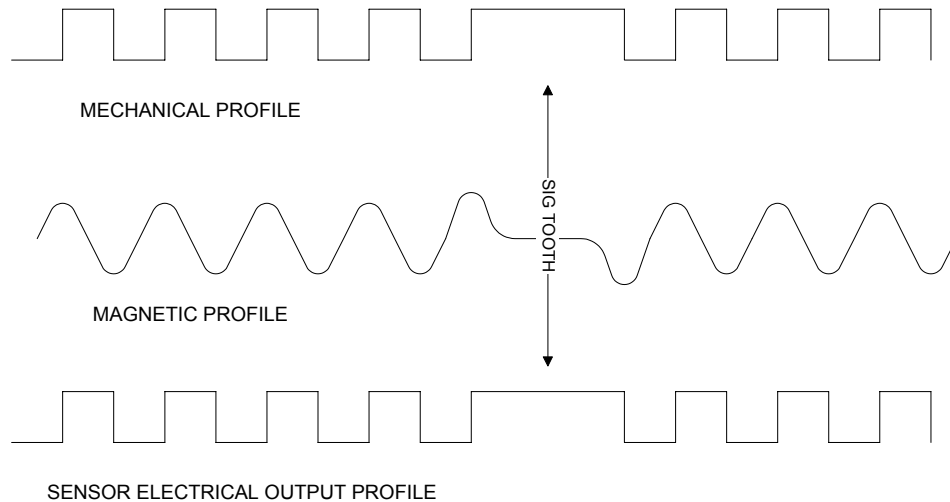

Output Polarity:

The output of the sensor will switch from LOW to HIGH as the leading edge of the tooth passes the sensor face in the direction indicated in the figure below. In this system configuration, the output voltage will be high when the sensor is facing a tooth. If rotation occurs in the opposite direction, the output polarity will invert.

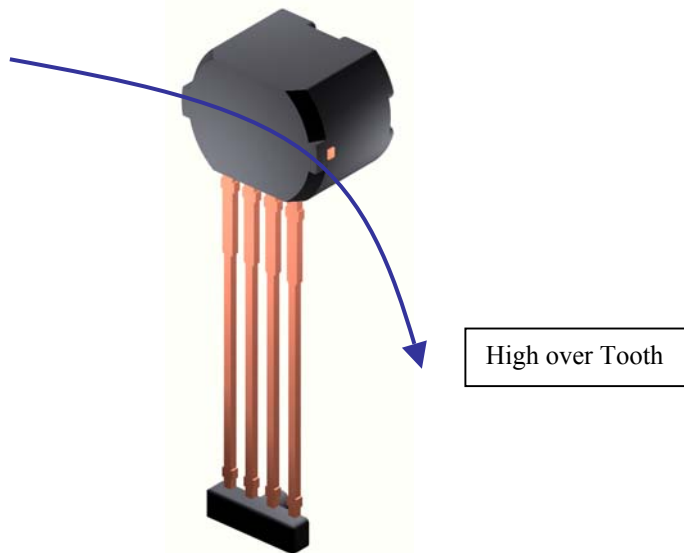

Power-On State Operation:

The device is guaranteed to power up in the OFF state (logic high output).

ATS625 PRELIMINARY

Start-up Detection:

Since the sensor powers up in the OFF state (logic high output), the first edge seen by the sensor can be missed if the switching induced by that edge reinforces the OFF state. Therefore, the first edge that can be guaranteed to induce an output transition is the second detected edge. This device has accurate first electrical falling edge detection. The tables below show various start-up schemes.

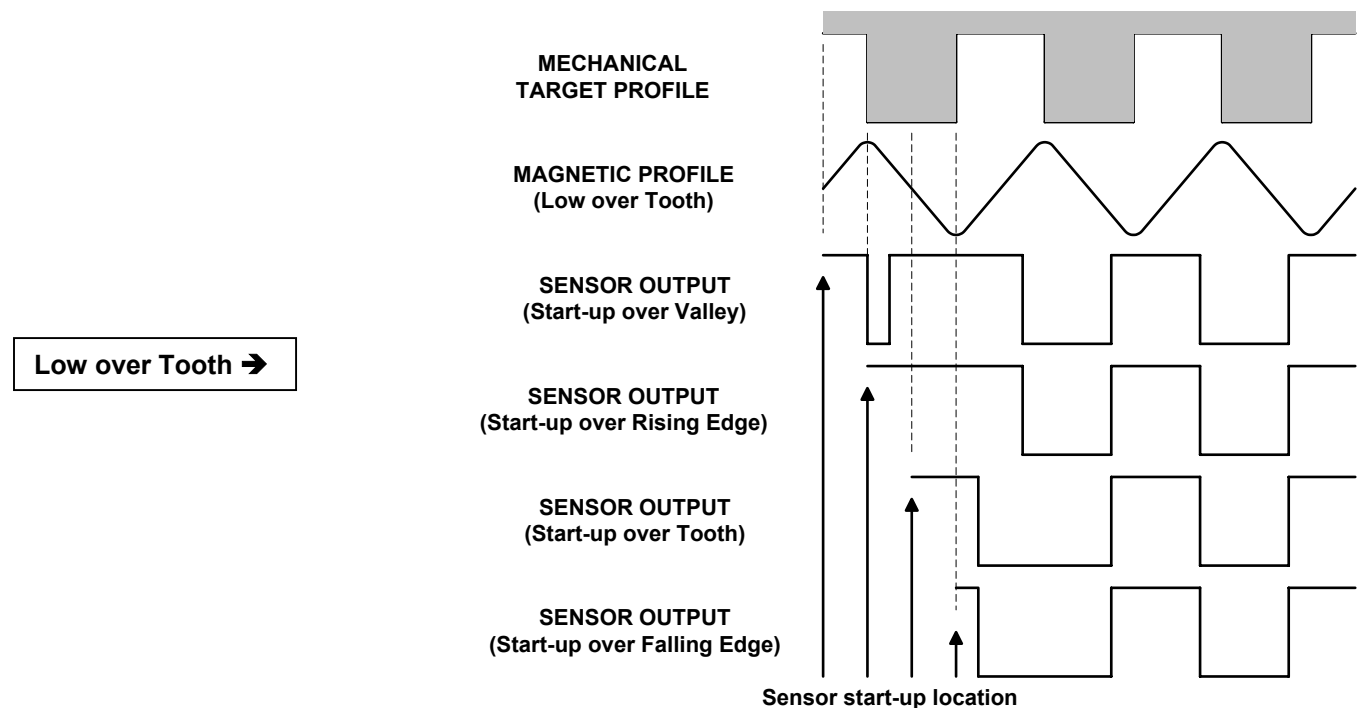
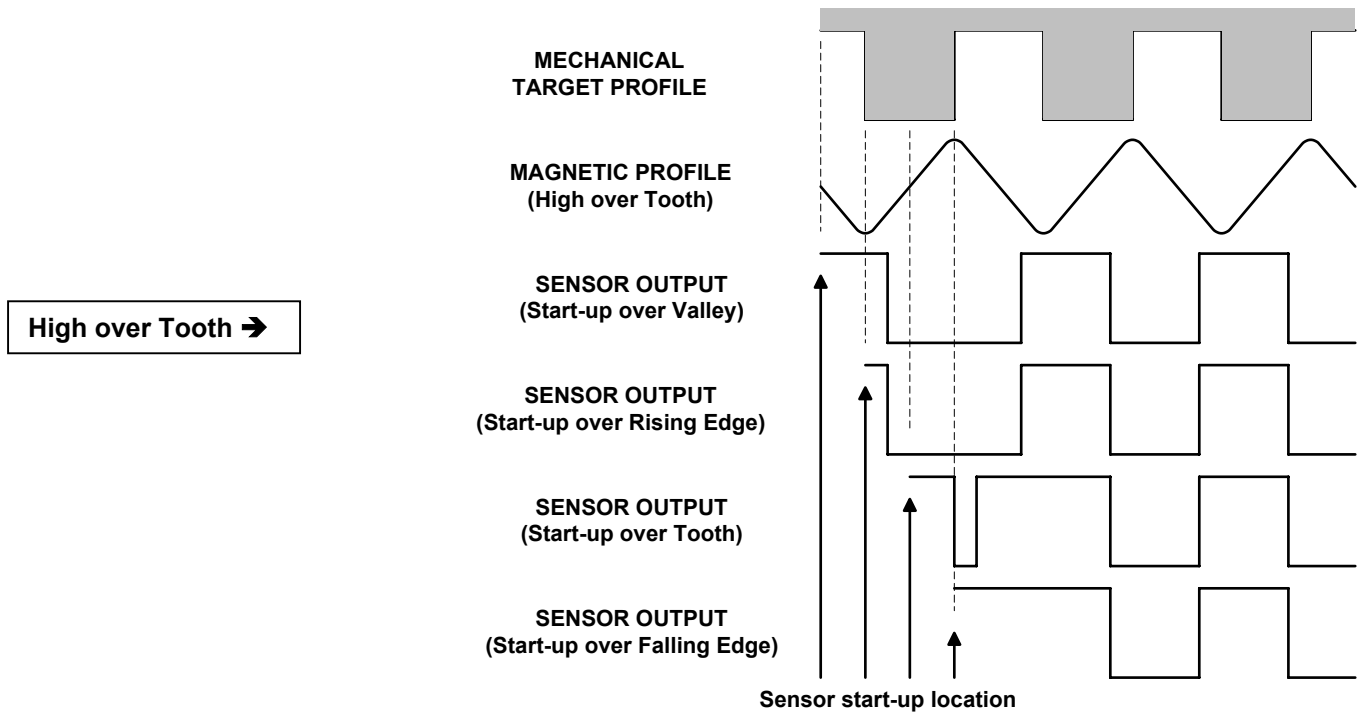

ATS625 PRELIMINARY

Under Voltage Lockout:

When the supply voltage falls below the minimum operating voltage (V_{CCUV}), the device turns OFF and stays OFF irrespective of the state of the magnetic field. This prevents false signals caused by under-voltage conditions from propagating to the output of the sensor.

Power Supply Protection:

The device contains an on-chip regulator and can operate over a wide supply voltage range. For devices that need to operate from an unregulated power supply, transient protection must be added externally. For applications using a regulated line, EMI/RFI protection may still be required. The following circuit is the most basic configuration required for proper device operation. Contact Allegro Microsystems for the circuitry needed for compliance to various EMC specifications.

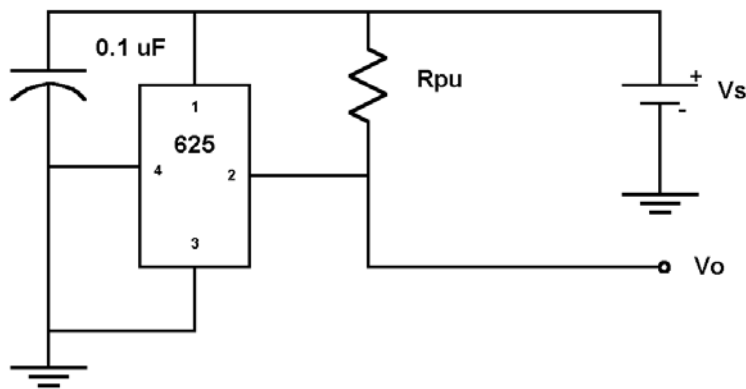

Internal Electronics:

The ATS625LSG contains a self-calibrating Hall effect IC that possesses two Hall elements, a temperature compensated amplifier and offset cancellation circuitry. The IC also contains a voltage regulator that provides supply noise rejection over the operating voltage range. The Hall transducers and the electronics are integrated on the same silicon substrate using a proprietary BiCMOS process. Changes in temperature do not greatly affect this device due to the stable amplifier design and the offset rejection circuitry.

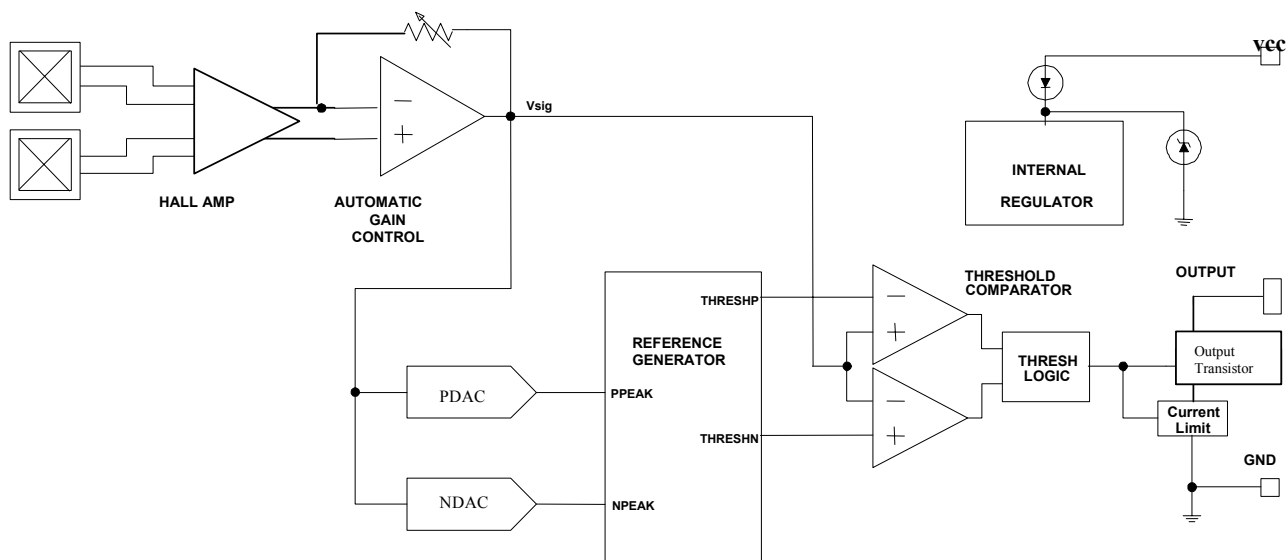

SENSOR OPERATION: AUTOMATIC GAIN CONTROL (AGC)

The patented self-calibrating circuitry is unique. After each power up, the device measures the peak-to-peak magnetic signal. The gain of the sensor is then adjusted which keeps the internal signal amplitude constant over the air gap range of the device. This feature provides operational characteristics independent of air gap.

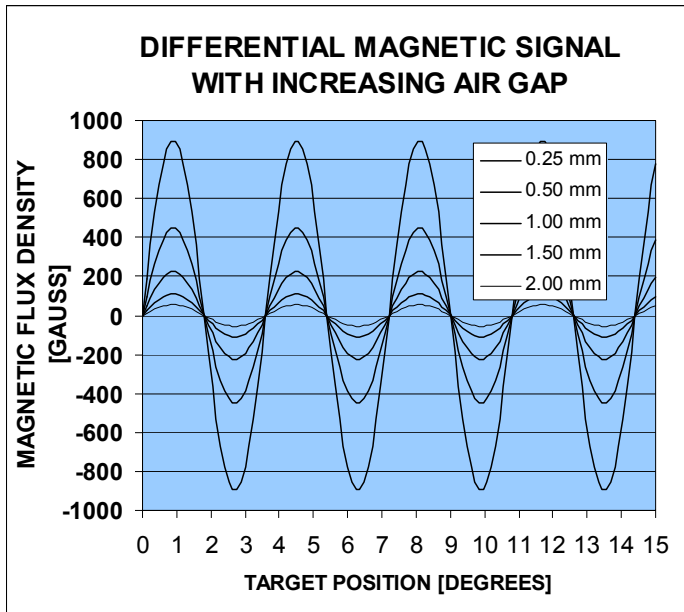

Magnetic Signal with no Amplification

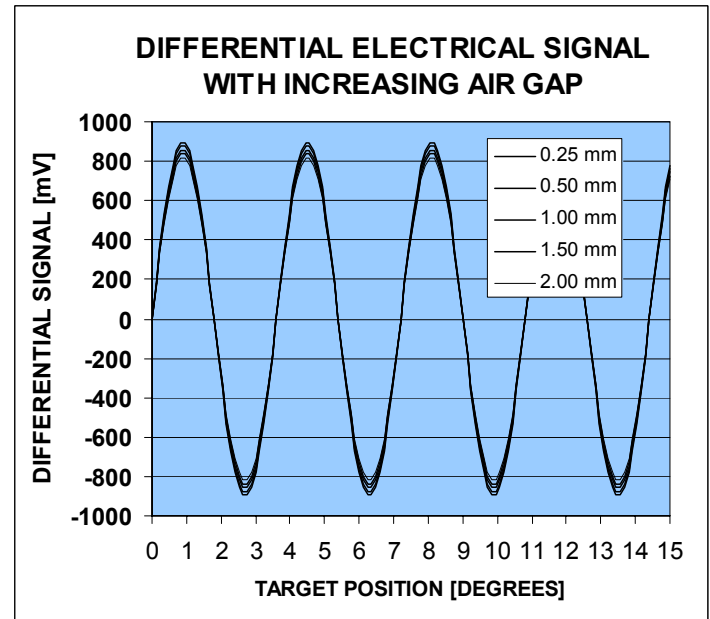

Electrical Signal after AGC

SENSOR OPERATION: OFFSET COMPENSATION

In addition to normalizing performance over air gap, the gain control circuitry also reduces the effect of chip, magnet, and installation offsets. This is accomplished using two D/A converters that capture the peak and valley of the signal and use it as a reference for the switching comparator. If induced offsets bias the absolute signal up or down, AGC and the dynamic DAC behavior work to normalize and reduce the impact of the offset on sensor performance.

SENSOR OPERATION: SWITCH POINTS

Switch points in the ATS625LSG are established dynamically as a percentage of the amplitude of the normalized magnetic signal. Two DACs track the peaks of the normalized magnetic signal (see the section on Update); the switching thresholds are established at 40% and 60% of the two DAC's values. The proximity of the thresholds near 50% ensures the most accurate and consistent switching where the signal is steepest and least affected by air gap variation.

The low hysteresis of 20% provides high air gap performance and immunity to false switching on noise, vibration, backlash and other transient events.

The figure below graphically demonstrates the establishment of the switching threshold levels.

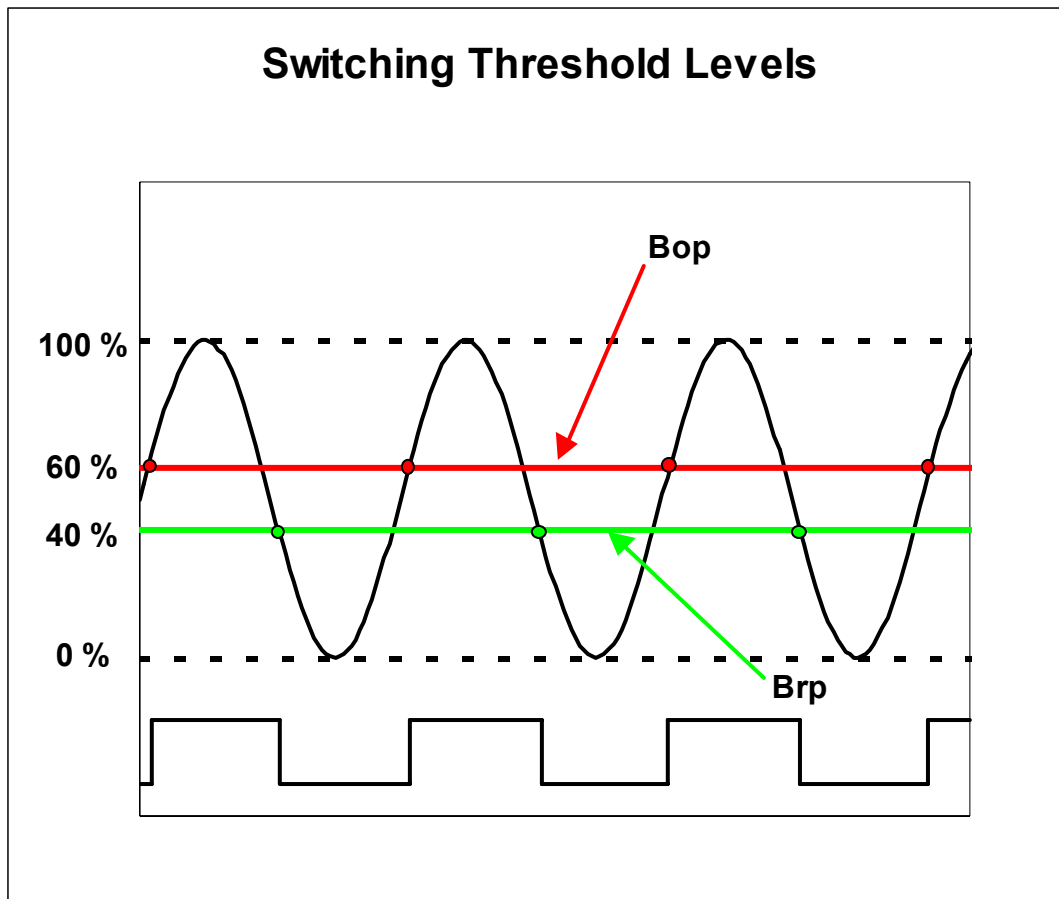

Because the thresholds are established dynamically as a percentage of the peak-peak signal, the effect of a baseline shift is minimized. As a result, the effects of offsets induced by tilted or off-center installation are minimized.

SENSOR OPERATION: UPDATE

The ATS625LSG incorporates an algorithm that continuously monitors the system and updates the switching thresholds accordingly. The switch point for each edge is determined by the previous two edges. Since variations are tracked in real time, the sensor has high immunity to target run-out and retains excellent accuracy and functionality in the presence of both run-out and transient mechanical events. The figures below show how the sensor uses historical data to provide the switching threshold for a given edge.

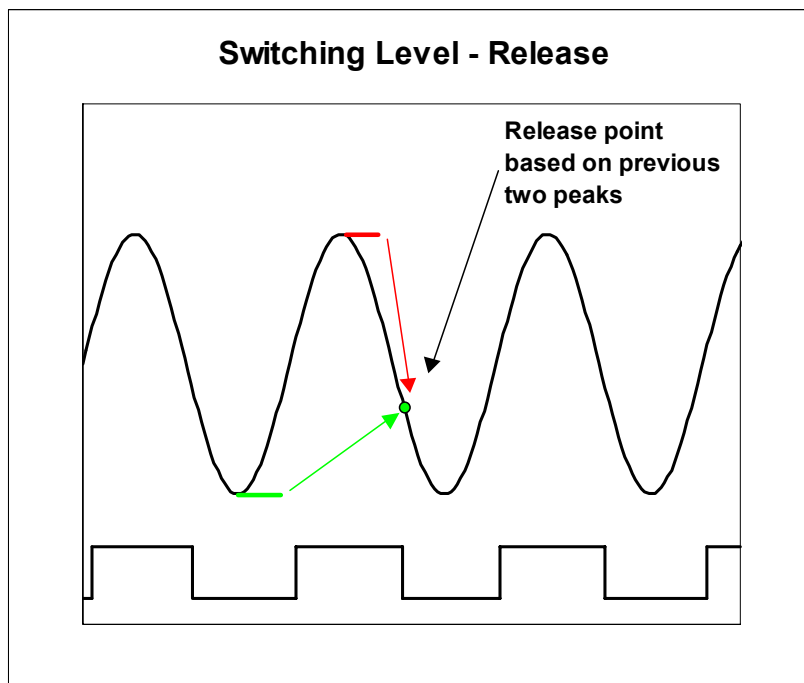
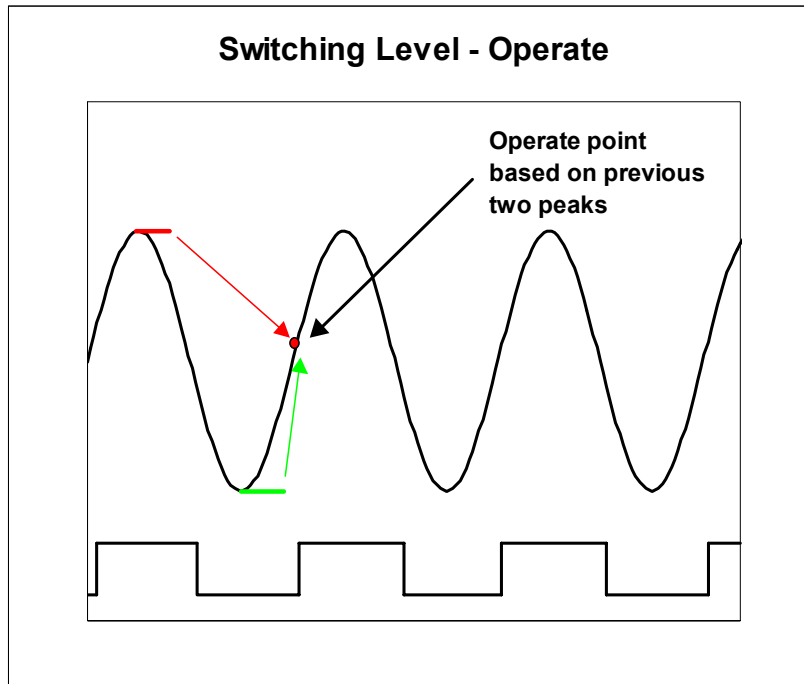

SENSOR/TARGET EVALUATION

In order to establish the proper operating specification for a particular sensor/target system, a systematic evaluation of the magnetic circuit should be performed. The first step is the generation of a magnetic map of the target. By using a calibrated device, a magnetic signature of the system is made. The following is a map of the 60+2 reference target.

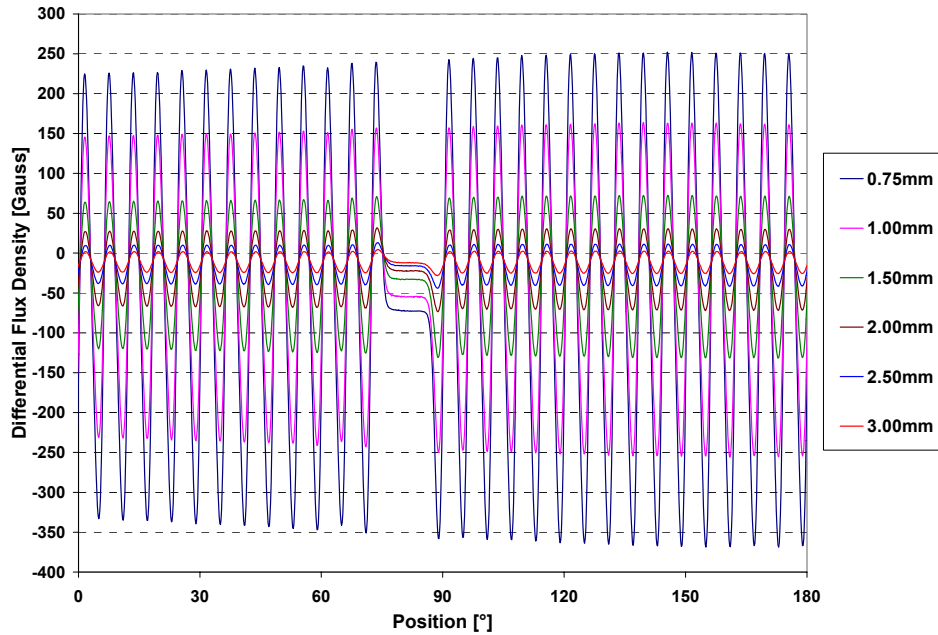

A single curve is distilled from this map data that describes the peak-peak magnetic field versus air gap. Knowing the minimum amount of magnetic flux density that guarantees operation of the sensor, one can determine the maximum operational air gap of the sensor/target system. Referring to the chart below, a minimum required peak-peak signal of 60G corresponds to a maximum air gap of approximately 2.5 mm.

ATS625LSG 60+2 Target Map

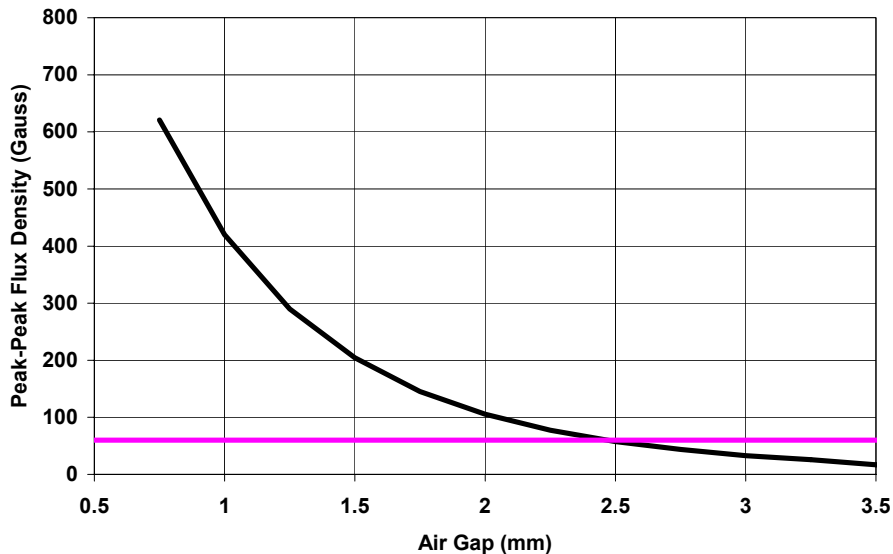

TARGET DESIGN

For the generation of adequate magnetic field levels, the following recommendations should be followed in the design and specification of targets.

- 2 mm < Tooth width < 4 mm
- Valley width > 2 mm
- Valley depth > 2 mm
- Gear thickness > 3 mm
- Target material must be low carbon steel

Though these parameters apply to targets of traditional geometry (radially oriented teeth with radial sensing), they can be applied to stamped targets and axially sensed targets as well. For stamped geometries with axial sensing, the valley depth is intrinsically infinite so the criteria for tooth width, valley width, material thickness (can be < 3 mm) and material specification need only be considered.

SENSOR EVALUATION: ACCURACY

While the update algorithm will allow the sensor to adapt to system changes (e.g. air gap increase), major changes in air gap can adversely affect switching performance. When characterizing sensor performance over a significant air gap range, be sure to re-power the device at each air gap. This ensures that self-calibration occurs for each installation condition. See the specifications on page 3 and the section entitled Characteristic Data for timing accuracy performance.

SENSOR EVALUATION: REPEATABILITY

Repeatability measurement methodology has been formulated to minimize the effect of test system jitter on device measurements. By triggering the measurement equipment (oscilloscope) close to the desired output edge, the speed variations that occur within a single revolution of the target are effectively nullified. Because the trigger event occurs a very short time before the measured event, little opportunity is given for measurement system jitter to impact the time-based measurements. After the data is taken on the oscilloscope, statistical analysis of the distribution is made to quantify variability and capability. Though complete repeatability results can be found in the Characteristic Data section of this document, the following figure shows the correlation between magnetic signal strength and repeatability. Since an inverse relationship exists between magnetic signal strength and low repeatability, optimum repeatability performance can be attained through minimizing the operating air gap and optimizing the target design.

Repeatability Measurement Methodology

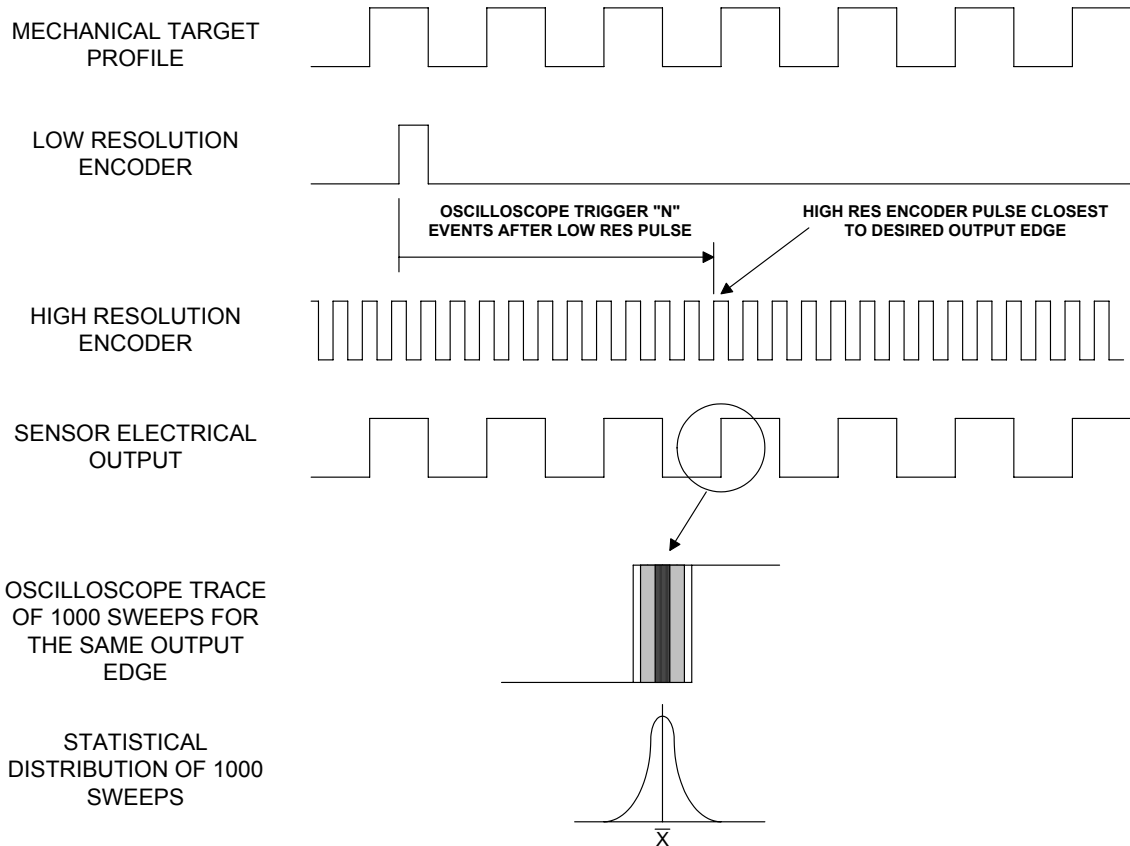

SENSOR EVALUATION: EMC

Characterization Only

Test Name	Reference Specification
ESD – Human Body Model	AEC-Q100-002
ESD – Machine Model	AEC-Q100-003
Conducted Transients	ISO 7637-1
Direct RF Injection	ISO 11452-7
Bulk Current Injection	ISO 11452-4
TEM Cell	ISO 11452-3

Please contact Allegro Microsystems for EMC performance

ATS625 PRELIMINARY

MECHANICAL INFORMATION

Component	Material	Description	Value
Element Spacing		Hall sensing element spacing	2.2 mm
Back-biasing Magnet	Rare Earth	South pole behind IC	
Sensor Package Material	Thermoset Epoxy	Maximum Temperature	170°C ¹
Leads	Copper		Solder, Tin / Lead 90/10 ²

- 1 Temperature excursions of up to 260°C for 2 minutes or less are permitted (based on delamination studies).
- 2 Industry accepted soldering techniques are acceptable for this package as long as the indicated maximum temperature is not exceeded.

DEVICE QUALIFICATION PROGRAM

Test Name	Test Conditions	Test Length	# of Lots	Sample / lot	Comments
Pre/Post Test	Ta = room, hot, cold				
High Temperature Operating Life (HTOL)	Ta = 150°C, Tj ≤ 170°C	408 hrs	1	77	JESD22-A108
High Temperature Bake (HTB)	Ta = 170°C	1000 hrs	1	77	JESD22-A103
Pre Conditioning (PC)	85°C/85%RH	168 hrs	1	231	JESD22-A112 & A113
Temperature Humidity Bias (THB) or HAST	85°C/85%RH 130°C/85%RH	1000 hrs 50 hrs	1	77	JESD22-A101 JESD22-A110
Autoclave (AC)	121°C/15 psig	96 hrs	1	77	JESD22-A102
Temperature Cycle (TC)	-65°C to +150°C or -50°C to +150°C	500 cycles 1000 cycles	1	77	JESD22-A104
External Visual (EV)					
Physical Dimensions (PD)			1	30	
Lead Integrity			1	45	
Bond Pull Strength			1	30	
ESD	HBM & MM		1	3 per model per V step	JESD22-A114 & A115, CDF-AEC-Q100-002, 003 & 011
Solderability (SD)			1	15	JESD22-B102
Early Life Failure Rate (ELFR)	125°C or 150°C	48 hrs 24 hrs	1	800	JESD22-A108
Gate Leakage (GL)			1	6	CDF- AEC-Q100-006
Electrical Distributions (ED)	Ta = room, hot, cold		3	30	

POWER DE-RATING

Due to internal power consumption, the junction temperature of the IC, T_j , is higher than the ambient environment temperature, T_a . To ensure that the device does not operate above the maximum rated junction temperature use the following calculations:

$$\Delta T = P_D * R\theta_{ja}$$

Where: $P_D = V_{cc} * I_{cc}$

$$\therefore \Delta T = V_{cc} * I_{cc} * R\theta_{ja}$$

Where ΔT denotes the temperature rise resulting from the IC's power dissipation.

$$T_j = T_a + \Delta T$$

For the sensor :

$$T_j(\text{max}) = 165^\circ\text{C}$$

$$R\theta_{ja} = 126^\circ\text{C/W}$$

Typical T_j calculation:

$$T_a = 25^\circ\text{C}$$

$$V_{cc} = 5\text{ V}$$

$$I_{cc} = 9.0\text{ mA}$$

$$P_D = V_{cc} * I_{cc} = 5\text{ V} * 9.0\text{ mA} = 45.0\text{ mW}$$

$$\Delta T = P_D * R\theta_{ja} = 45.0\text{ mW} * 126^\circ\text{C/W} = 5.7^\circ\text{C}$$

$$T_j = T_a + \Delta T = 25^\circ\text{C} + 5.7^\circ\text{C} = 30.7^\circ\text{C}$$

Maximum Allowable Power Dissipation Calculation for ATS625LSG:

Assume:

$$T_a = T_{a_{\text{max}}} = 150^\circ\text{C}$$

$$T_j(\text{max}) = 165^\circ\text{C}$$

$$I_{cc} = 8.0\text{ mA}^5$$

If:

$$T_j = T_a + \Delta T$$

⁵max I_{cc} @ 150C < max I_{cc} @ 25C, see characteristic data

Then, at $T_a = 150^\circ\text{C}$:

$$\Delta T_{\text{max}} = T_{j_{\text{max}}} - T_{a_{\text{max}}} = 165^\circ\text{C} - 150^\circ\text{C} = 15^\circ\text{C}$$

If:

$$\Delta T = P_D * R\theta_{ja}$$

Then, at $T_a = 150^\circ\text{C}$:

$$P_{D_{\text{max}}} = \Delta T_{\text{max}} / R\theta_{ja} = 15^\circ\text{C} / 126^\circ\text{C/W} = 119\text{ mW}$$

If:

$$P_D = V_{cc} * I_{cc}$$

Then the maximum V_{cc} at 150°C is therefore:

$$V_{cc_{\text{max}}} = P_{D_{\text{max}}} / I_{cc} = 119\text{ mW} / 9.0\text{ mA} = 13.2\text{ V}$$

This value applies only to the voltage drop across the 625 chip. If a protective series diode or resistor is used, the effective maximum supply voltage is increased.

For example, when a standard diode with a 0.7 V drop is used:

$$V_{s_{\text{max}}} = 13.2\text{ V} + 0.7\text{ V} = 13.9\text{ V}$$

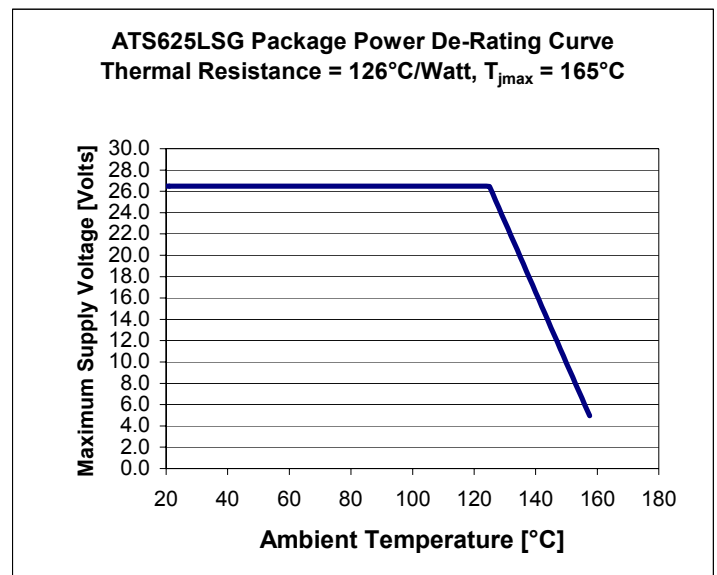

CHARACTERISTIC DATA: ELECTRICAL

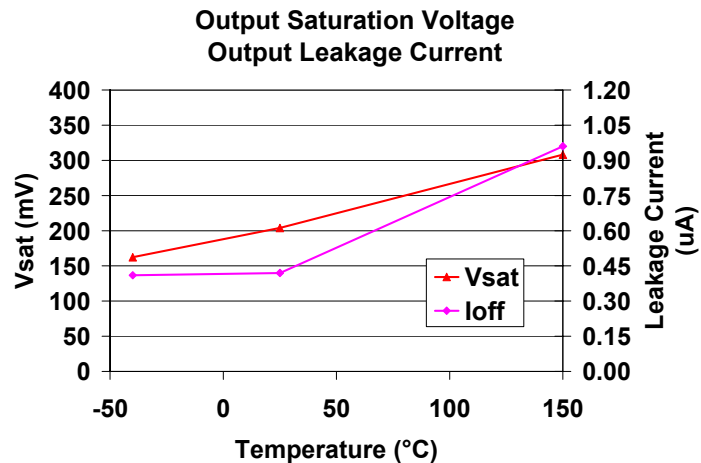
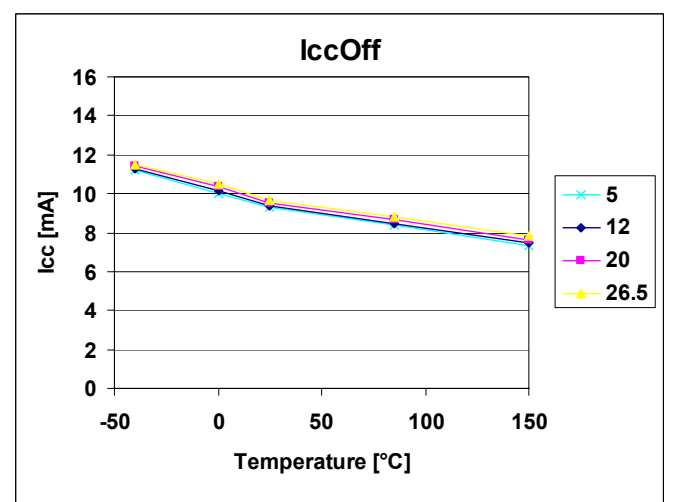
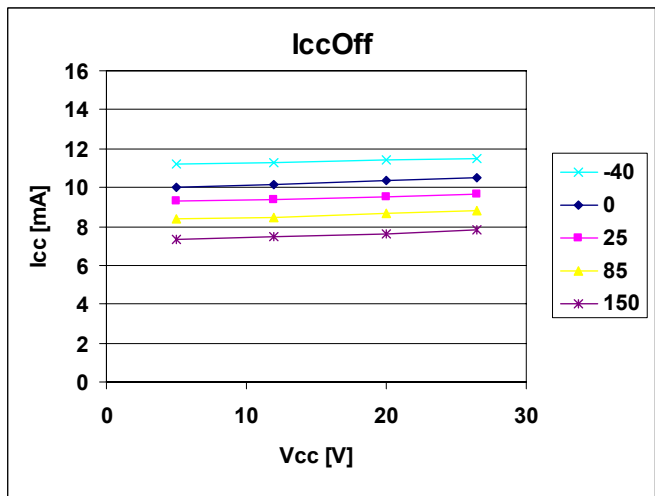
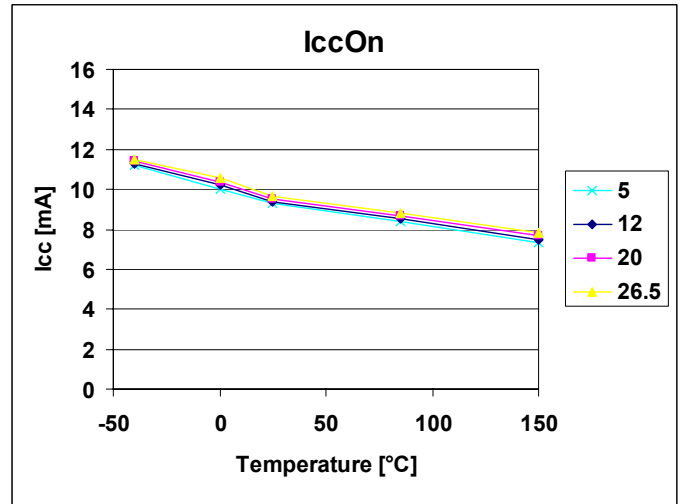
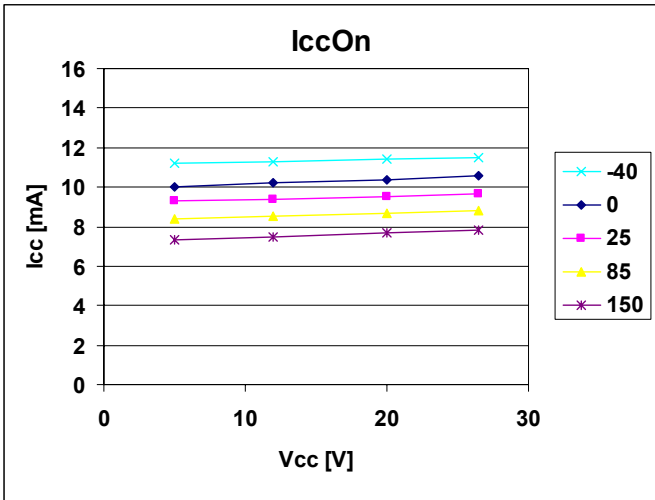

CHARACTERISTIC DATA: RELATIVE TIMING ACCURACY

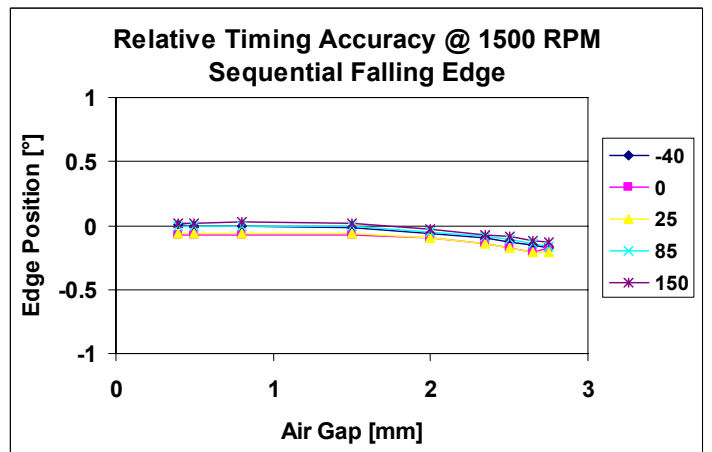
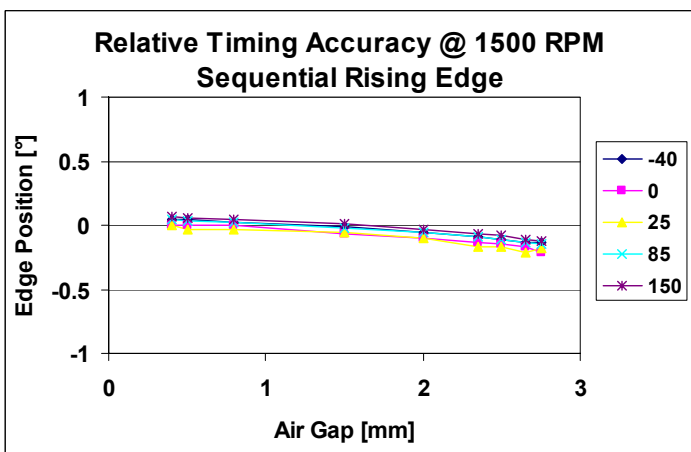
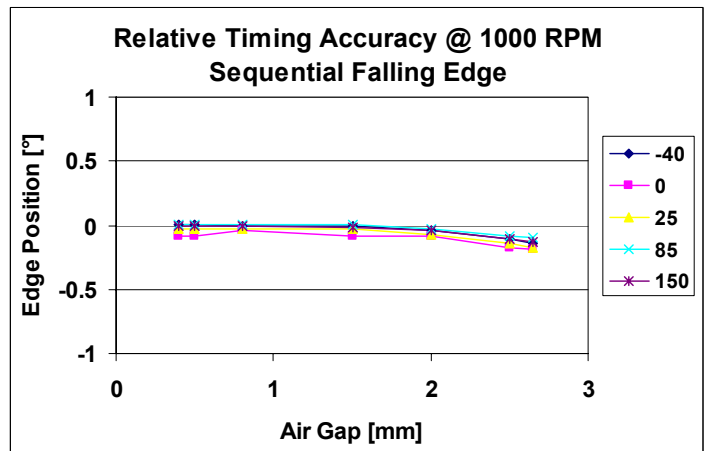
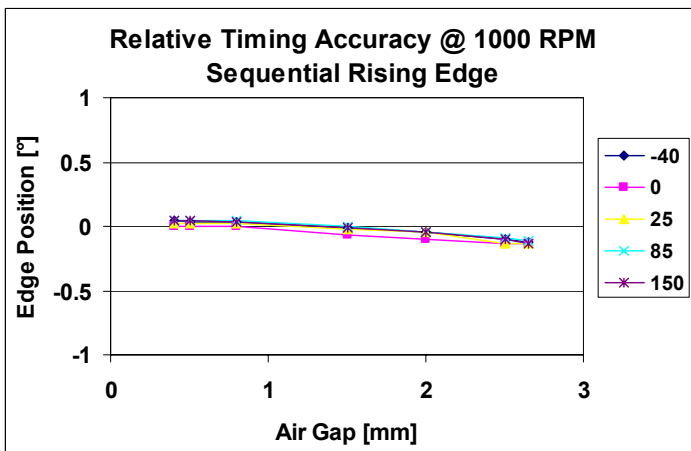
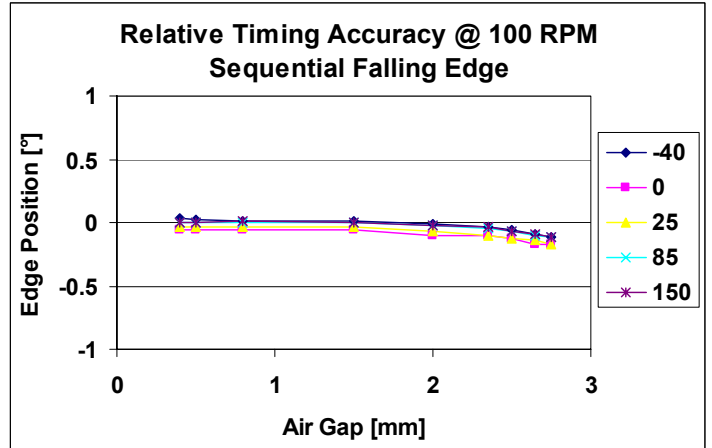
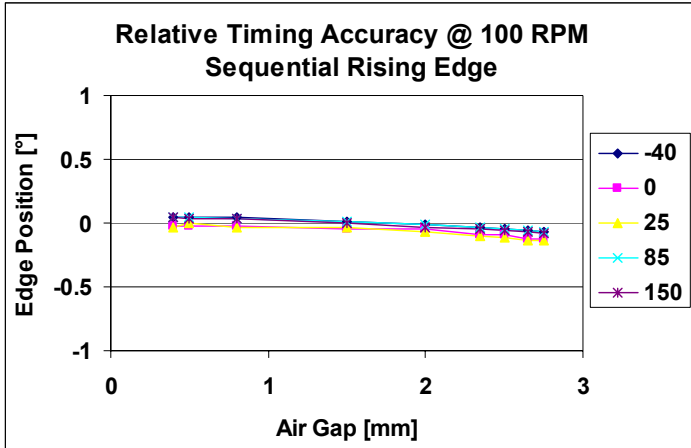

CHARACTERISTIC DATA: RELATIVE TIMING ACCURACY

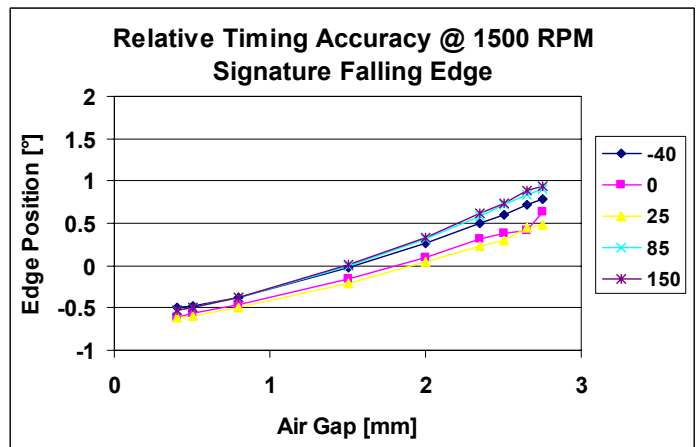
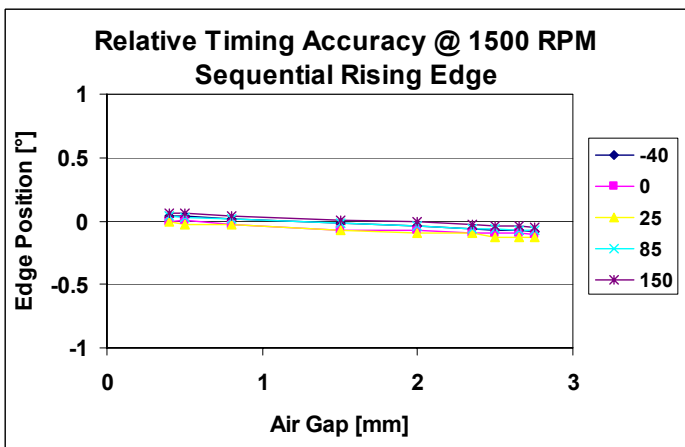
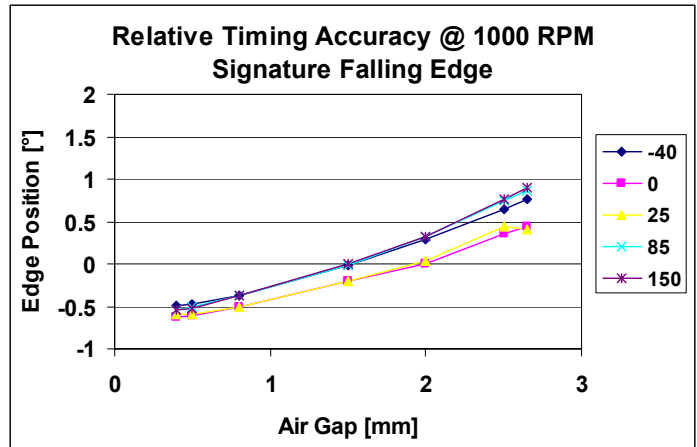
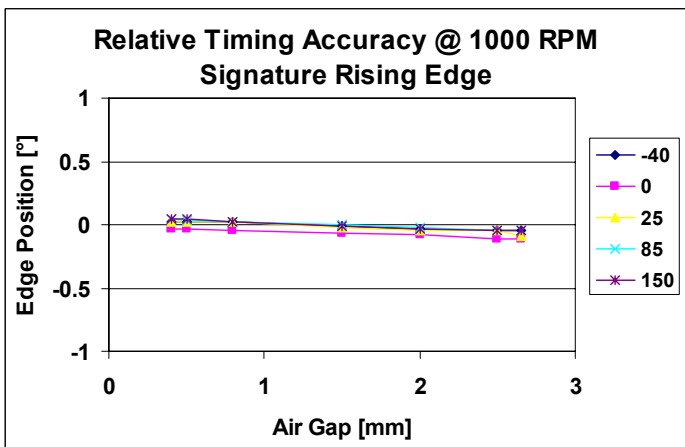
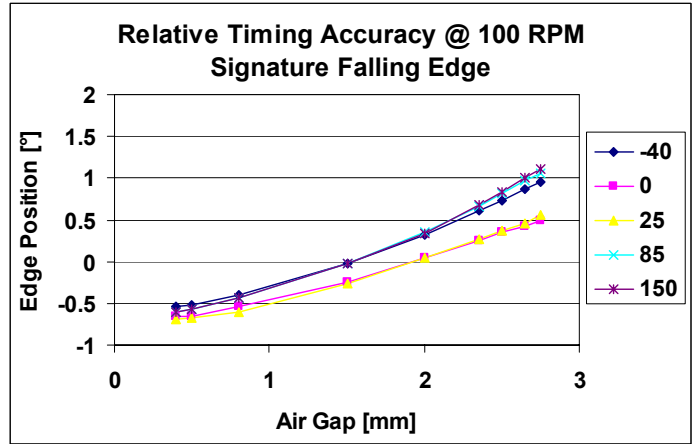
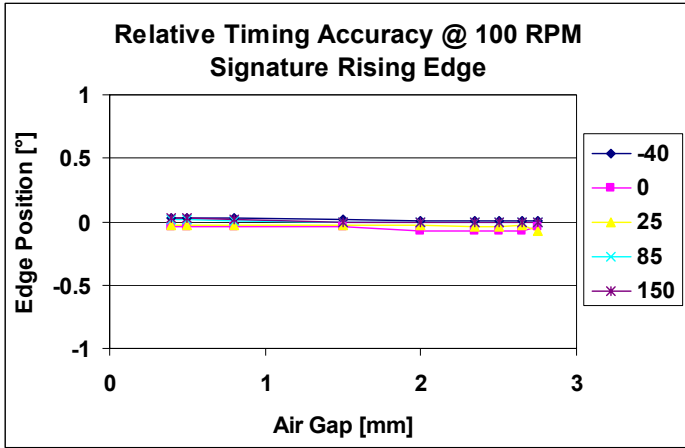

CHARACTERISTIC DATA: RELATIVE TIMING ACCURACY

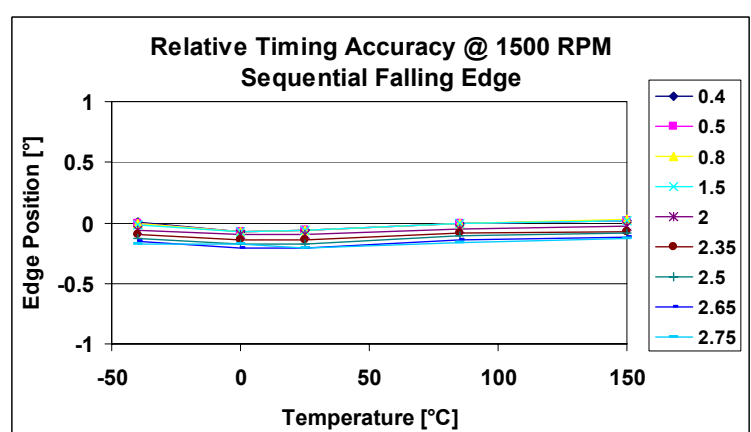
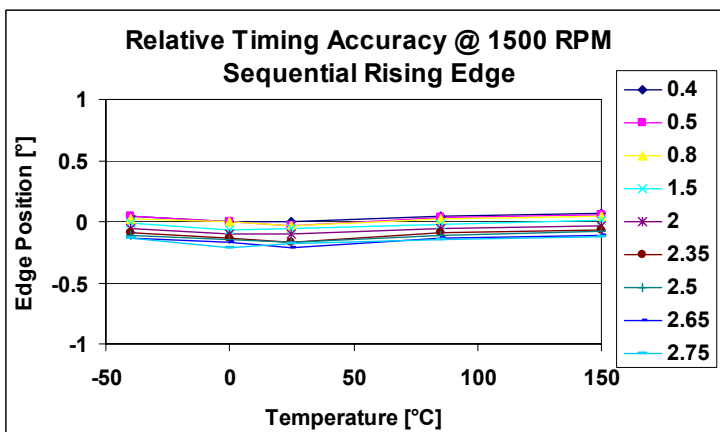
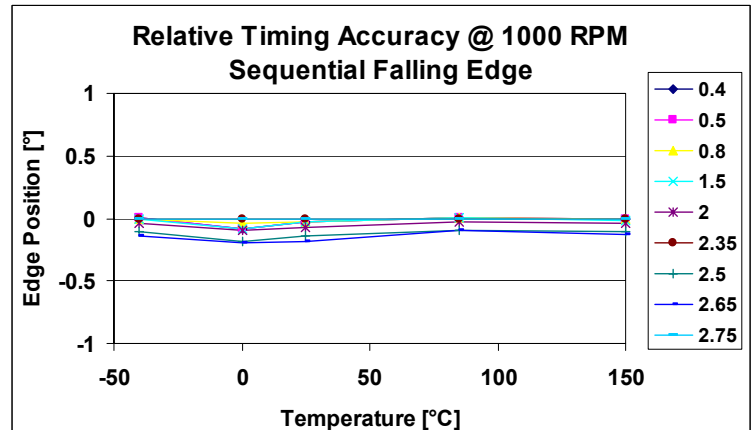
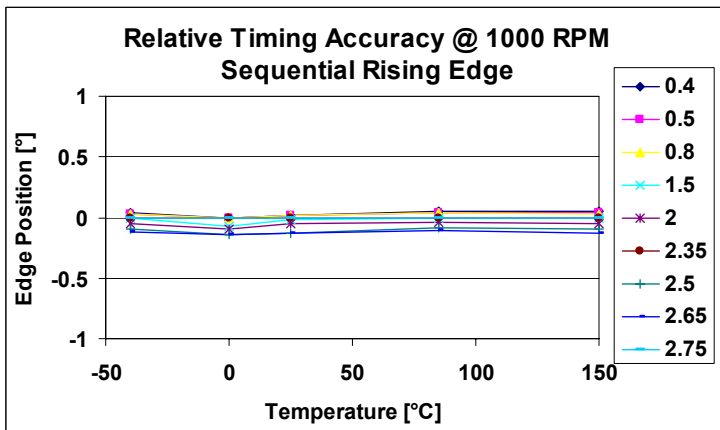
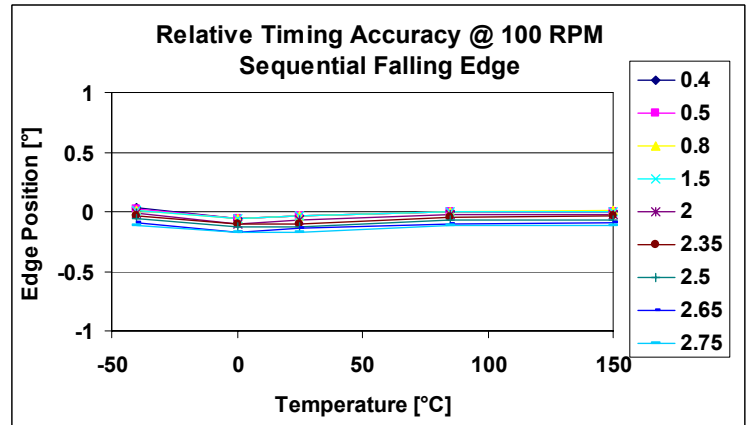
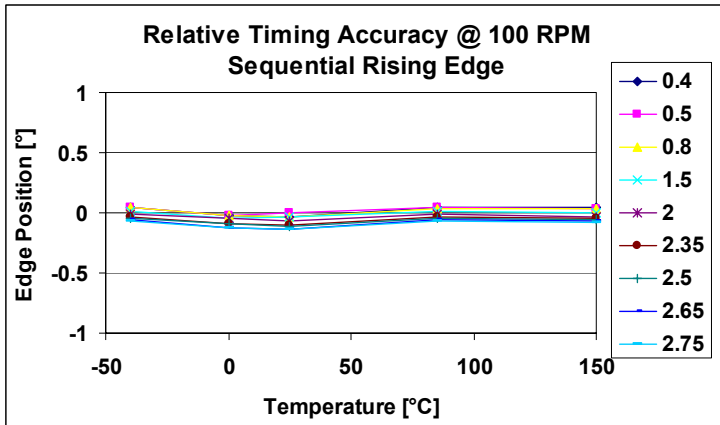

CHARACTERISTIC DATA: RELATIVE TIMING ACCURACY

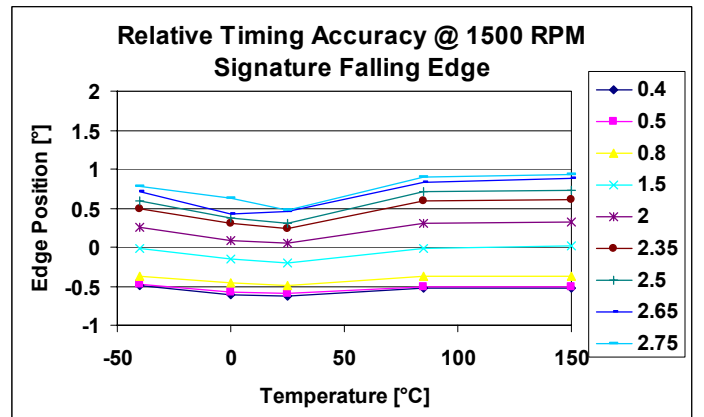
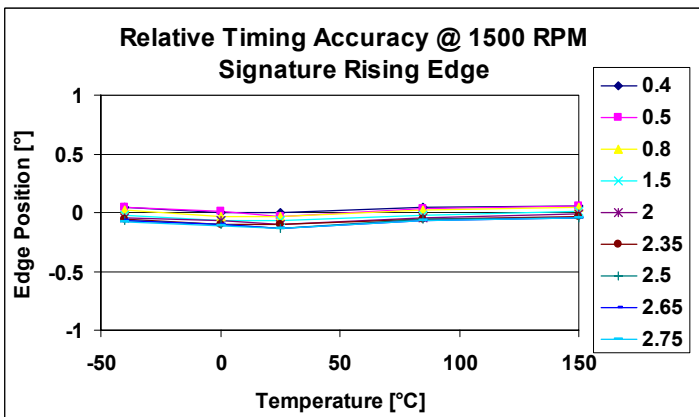
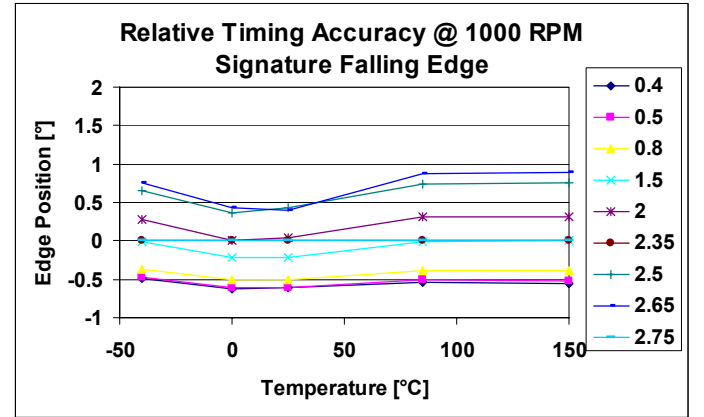
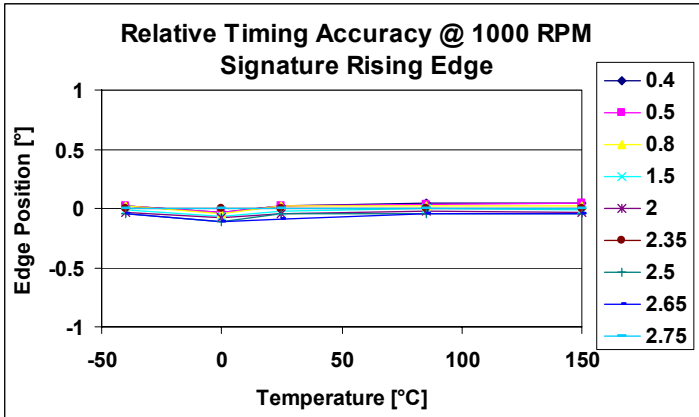
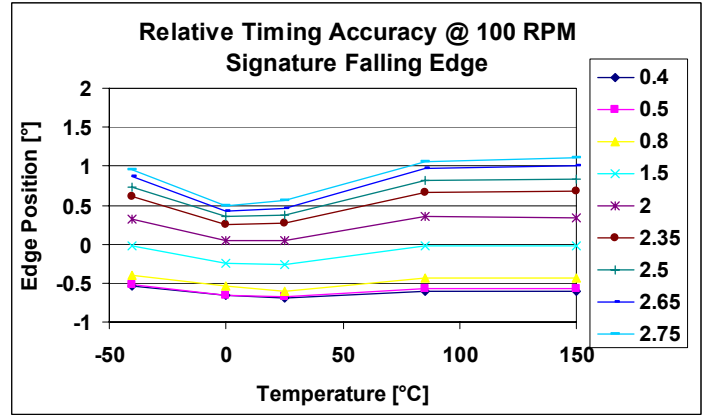
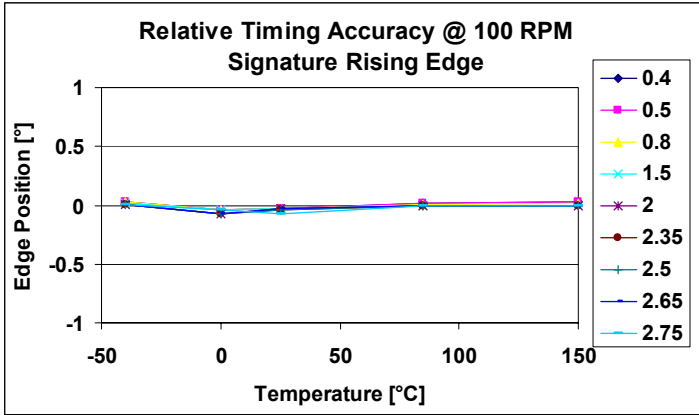

CHARACTERISTIC DATA: REPEATABILITY

360° Repeatability @ 1000 RPM
Allegro 60+2 Standard Target
Sequential Falling Edge

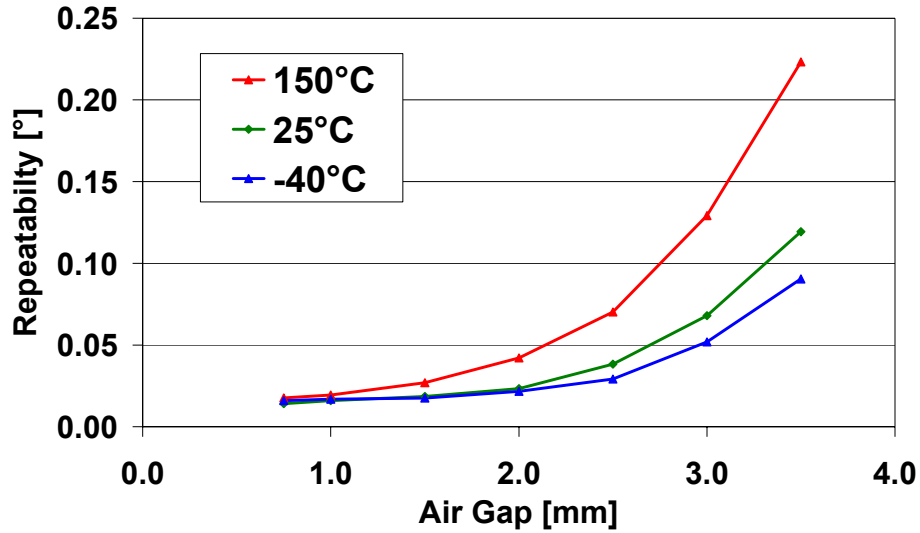

ATS625 PRELIMINARY

PACKAGE DRAWING

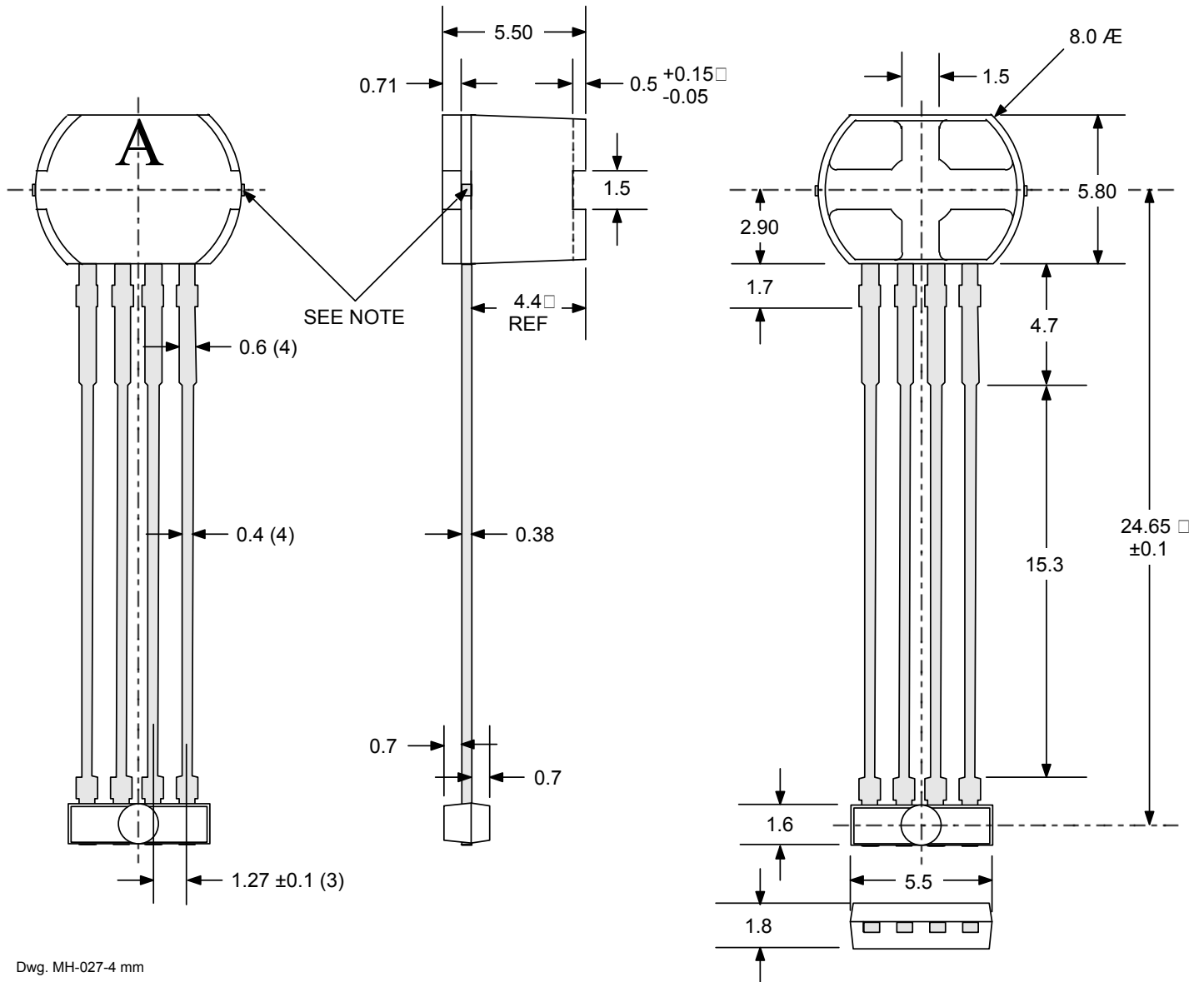

Additional Applications Information on gear tooth and other Allegro sensors can be obtained at Allegro's web site, www.allegromicro.com or from Allegro's CDRom AMS-702.