

AS5311

High Resolution Magnetic Linear Encoder

1 General Description

The AS5311 is a contactless high resolution magnetic linear encoder for accurate linear motion and off-axis rotary sensing with a resolution down to $<0.5\mu\text{m}$. It is a system-on-chip, combining integrated Hall elements, analog front end and digital signal processing on a single chip, packaged in a small 20-pin TSSOP package.

A multi-pole magnetic strip or ring with a pole length of 1.0mm is required to sense the rotational or linear motion. The magnetic strip is placed above the IC at a distance of typ. 0.3mm.

The absolute measurement provides instant indication of the magnet position within one pole pair with a resolution of 488nm per step (12-bit over 2.0mm). This digital data is available as a serial bit stream and as a PWM signal.

Furthermore, an incremental output is available with a resolution of $1.95\mu\text{m}$ per step. An index pulse is generated once for every pole pair (once per 2.0mm). The travelling speed in incremental mode is up to 650mm/second.

An internal voltage regulator allows the AS5311 to operate at either 3.3 V or 5 V supplies. Depending on the application the AS5311 accepts multi-pole strip magnets as well as multi-pole ring magnets, both radial and axial magnetized (see [Figure 1](#) and [Figure 3](#)).

The AS5311 is available in a PB-free TSSOP-20 package and qualified for an ambient temperature range from -40°C to $+125^{\circ}\text{C}$.

2 Key Features

- Two 12-bit digital absolute outputs:
 - Serial interface and
 - Pulse width modulated (PWM) output
- Incremental output with Index
- “Red-Yellow-Green” indicators monitor magnet placement over the chip

3 Applications

- Micro-Actuator feedback
- Servo drive feedback
- Robotics
- Replacement of optical encoders

Figure 1. AS5311 Block Diagram

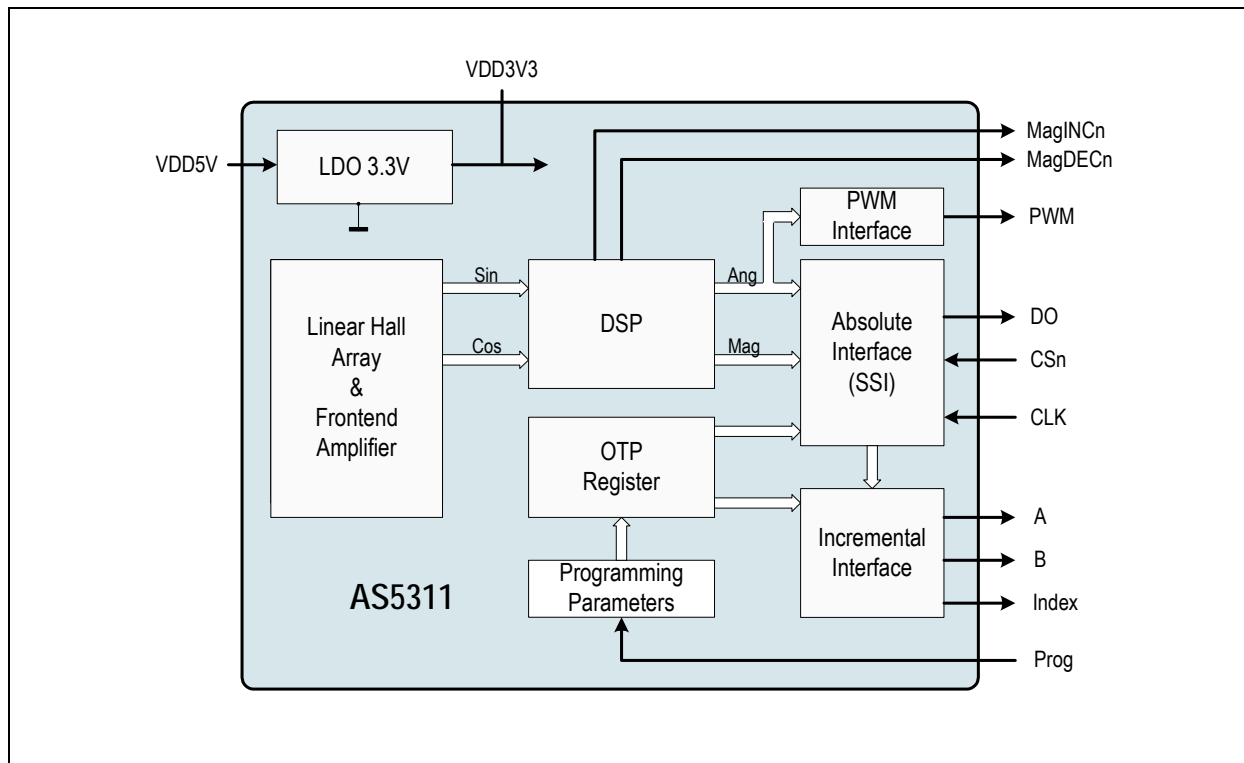



Contents

1	General Description	1
2	Key Features.....	1
3	Applications.....	1
4	Pin Assignments	3
4.1	Pin Descriptions.....	3
5	Absolute Maximum Ratings	5
6	Electrical Characteristics.....	6
6.1	Operating Conditions.....	6
6.2	DC Characteristics for Digital Inputs and Outputs	6
6.2.1	CMOS Schmitt-Trigger Inputs: CLK, CSn (CSn = internal Pull-up)	6
6.2.2	CMOS Output Open Drain: MagINCn, MagDECn	6
6.2.3	CMOS Output: PWM	6
6.2.4	Tristate CMOS Output: DO	7
6.3	Magnetic Input Specification.....	7
6.4	Electrical System Specifications.....	8
6.5	Timing Characteristics	9
6.5.1	Pulse Width Modulation Output	9
7	Detailed Description.....	10
7.1	Incremental Outputs	11
7.1.1	Incremental Power-up Lock Option	11
7.2	Incremental Output Hysteresis	12
7.3	Synchronous Serial Interface (SSI)	12
7.4	Absolute Output Jitter and Hysteresis	14
7.4.1	Adding a Digital Hysteresis.....	14
7.4.2	Implementing Digital Filtering	14
7.5	Z-axis Range Indication ("Red/Yellow/Green" Indicator)	14
7.6	Pulse Width Modulation (PWM) Output.....	15
7.7	3.3V / 5V Operation	16
8	Application Information	18
8.1	Magnetization	19
8.2	Position of the Index Pulse	19
8.3	Mounting the Magnet.....	20
8.3.1	Vertical Distance.....	20
8.3.2	Alignment of Multi-pole Magnet and IC.....	20
8.3.3	Lateral Stroke of Multi-pole Strip Magnets.....	20
8.4	Measurement Data Example	22
8.5	AS5311 Off-axis Rotary Applications.....	23
9	Package Drawings and Markings	25
9.1	Recommended PCB Footprint.....	26
10	Ordering Information	28



4 Pin Assignments

Figure 2. Pin Assignments (Top View)

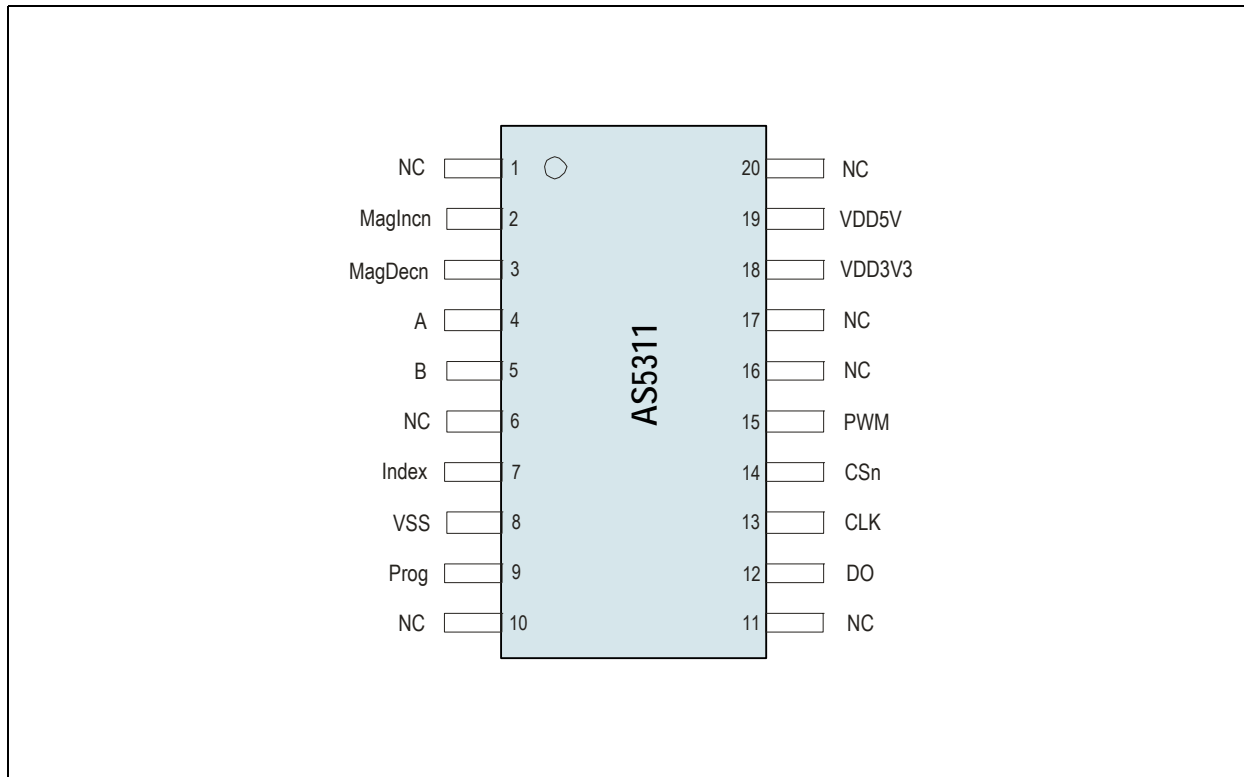

4.1 Pin Descriptions

Pin 4(A), 5(B) and 7(Index) are the incremental outputs. The incremental output has a resolution of 10-bit per pole pair, resulting in a step length of 1.95 μ m.

Note: Pin 14 (CSn) must be low to enable the incremental outputs.

Pins 12, 13 and 14 are used for serial data transfer. Chip Select (CSn; active low) initiates serial data transfer. CLK is the clock input and DO is the data output. A logic high at CSn puts the data output pin (DO) to tri-state and terminates serial data transfer. CSn must be low to enable the incremental outputs. See Section 7.1.1 for further options.

Pin 8 is the supply ground pin. Pins 18 and 19 are the positive supply pins.

For 5V operation, connect the 5V supply to pin 19 and add a 2 μ F...10 μ F buffer capacitor at pin 18.

For 3.3V operation, connect both pins 18 and 19 to the 3.3V supply.

Pin 9 is used for factory programming only. It should be connected to VSS.

Pins 2 and 3 are the magnetic field change indicators, MagINCn and MagDECn (magnetic field strength increase or decrease through variation of the distance between the magnet and the device). These outputs can be used to detect the valid magnetic field range.

External pull-up resistors are required at these pins. See Section 6.2.2 for maximum output currents on these pins. Since they are open-drain outputs they can also be combined (wired-and).

Pin 15 (PWM) allows a single wire output of the 12-bit absolute position value within one pole pair (2.0mm). The value is encoded into a pulse width modulated signal with 1 μ s pulse width per step (1 μ s to 4097 μ s over one pole pair).

Pins 1, 6, 10, 11, 16, 17 and 20 are for internal use and must not be connected.



Table 1. Pin Descriptions

Pin Number	Pin Name	Pin Type	Description
1	NC	-	Must be left unconnected
2	MagINCn	Digital output open drain	Indicates "Red/Yellow/Green Range" depending on the distance between device and magnet
3	MagDECn		Indicates "Red/Yellow/Green Range" depending on the distance between device and magnet
4	A	Digital output	Incremental output A
5	B		Incremental output B
6	NC	-	Must be left unconnected
7	Index	Digital output	Incremental output Index
8	VSS	Supply pin	Negative Supply Voltage (GND)
9	Prog	Digital input pull-down	OTP Programming Input for factory programming. Connect to VSS.
10	NC	-	Must be left unconnected
11	NC	-	Must be left unconnected
12	DO	Digital output /tri-state	Data Output of Synchronous Serial Interface
13	CLK	Digital input, Schmitt-Trigger input	Clock Input of Synchronous Serial Interface; Schmitt-Trigger input
14	CSn	Digital input pull-up, Schmitt-Trigger input	Chip Select, active low; Schmitt-Trigger input, internal pull-up resistor (~50k Ω). Must be low to enable incremental outputs
15	PWM	Digital output	Pulse Width Modulation of approx. 244Hz; 1 μ s/step
16	NC	-	Must be left unconnected
17	NC	-	Must be left unconnected
18	VDD3V3	Supply pin	3V-Regulator output; internally regulated from VDD5V. Connect to VDD5V for 3V supply voltage. Do not load externally.
19	VDD5V		Positive Supply Voltage, 3.0 to 5.5 V
20	NC	-	Must be left unconnected



5 Absolute Maximum Ratings

Stresses beyond those listed in [Table 2](#) may cause permanent damage to the device. These are stress ratings only, and functional operation of the device at these or any other conditions beyond those indicated in [Electrical System Specifications on page 8](#) is not implied. Exposure to absolute maximum rating conditions for extended periods may affect device reliability.

Table 2. Absolute Maximum Ratings

Parameter	Min	Max	Units	Comments
DC supply voltage at pin VDD5V	-0.3	7	V	
DC supply voltage at pin VDD3V3		5	V	
Input pin voltage	-0.3	VDD5V +0.3	V	Except VDD3V3
Input current (latchup immunity)	-100	100	mA	Norm: JEDEC 78
Electrostatic discharge		± 2	kV	Norm: MIL 883 E method 3015
Storage temperature	-55	125	°C	Min – 67°F; Max +257°F
Body temperature (Lead-free package)		260	°C	The reflow peak soldering temperature (body temperature) specified is in accordance with <i>IPC/JEDEC J-STD-020C "Moisture/Reflow Sensitivity Classification for Non-Hermetic Solid State Surface Mount Devices"</i> . The lead finish for Pb-free leaded packages is matte tin (100% Sn).
Humidity non-condensing	5	85	%	
Moisture Sensitive Level (MSL)		3		Represents a maximum floor time of 168h



6 Electrical Characteristics

$T_{AMB} = -40$ to $+125^{\circ}\text{C}$, $V_{DD5V} = 3.0$ - 3.6V (3V operation) $V_{DD5V} = 4.5$ - 5.5V (5V operation), unless otherwise noted.

6.1 Operating Conditions

Table 3. Operating Conditions

Symbol	Parameter	Note	Min	Typ	Max	Units
T_{AMB}	Ambient temperature	-40°F $+257^{\circ}\text{F}$	-40		125	$^{\circ}\text{C}$
I_{supp}	Supply current			16	21	mA
V_{DD5V} V_{DD3V3}	Supply voltage at pin VDD5V Voltage regulator output voltage at pin VDD3V3	5V Operation	4.5 3.0	5.0 3.3	5.5 3.6	V V
V_{DD5V} V_{DD3V3}	Supply voltage at pin VDD5V Supply voltage at pin VDD3V3	3.3V Operation (pin VDD5V and VDD3V3 connected)	3.0 3.0	3.3 3.3	3.6 3.6	V V

6.2 DC Characteristics for Digital Inputs and Outputs

6.2.1 CMOS Schmitt-Trigger Inputs: CLK, CSn (CSn = internal Pull-up)

Table 4. CMOS Schmitt-Trigger Inputs

Symbol	Parameter	Conditions	Min	Typ	Max	Units
V_{IH}	High level input voltage	Normal operation	$0.41 * V_{DD5V}$			V
V_{IL}	Low level input voltage				$0.13 * V_{DD5V}$	V
$V_{I_{on}} - V_{I_{off}}$	Schmitt Trigger hysteresis		1			V
I_{LEAK} I_{iL}	Input leakage current Pull-up low level input current	CLK only	-1		1	μA
		CSn only, VDD5V: 5.0V	-30		-100	

6.2.2 CMOS Output Open Drain: MagINCn, MagDECn

Table 5. CMOS Output Open Drain

Symbol	Parameter	Conditions	Min	Typ	Max	Units
V_{OL}	Low level output voltage				$V_{SS}+0.4$	V
I_o	Output current	VDD5V: 4.5V			4	mA
		VDD5V: 3V			2	
I_{oz}	Open drain leakage current				1	μA

6.2.3 CMOS Output: PWM

Table 6. CMOS Output

Symbol	Parameter	Conditions	Min	Typ	Max	Units
V_{OH}	High level output voltage		$V_{DD5V}-0.5$			V
V_{OL}	Low level output voltage				$V_{SS}+0.4$	V
I_o	Output current	VDD5V: 4.5V			4	mA
		VDD5V: 3V			2	



6.2.4 Tristate CMOS Output: DO

Table 7. Tristate CMOS Output

Symbol	Parameter	Conditions	Min	Typ	Max	Units
V _{OH}	High level output voltage		VDD5V -0.5			V
V _{OL}	Low level output voltage				VSS+0.4	V
I _O	Output current	VDD5V: 4.5V			4	mA
		VDD5V: 3V			2	

6.3 Magnetic Input Specification

Two-pole cylindrical diametrically magnetized source:

Table 8. Magnetic Input Specification

Symbol	Parameter	Note	Min	Typ	Max	Units
L _p	Pole length	Recommended magnet: plastic or rubber bonded ferrite or NdFeB		1		mm
t _{mag}	Pole pair length			2		mm
B _{pk}	Magnetic input field amplitude	Required vertical component of the magnetic field strength on the die's surface	10		40	mT
B _{off}	Magnetic offset	Constant magnetic stray field			± 5	mT
B _{tc}	Magnetic field temperature drift	Recommended magnet: plastic or rubber bonded ferrite or NdFeB			0.2	%/K
	Magnetic input field variation	Including offset gradient			±2	%
V _{abs}	Linear travelling speed	Incremental output: 1024 steps / polepair including interpolation ¹			650	mm/sec
Disp	Displacement	Maximum shift between defined Hall sensor center and magnet centerline; depends on magnet geometries		0.5		mm
Z _{Dist}	Vertical gap	Package to magnet surface; depends on magnet strength		0.3		mm
	Recommended magnet material and temperature drift	Plastic or rubber bonded Ferrite		-0.19		%K
		Plastic or rubber bonded Neodymium (NdFeB)		-0.12		

1. 1) For absolute outputs, a practical speed limit is 2345 mm/s. At higher speeds, input signal cancellation will occur and the detected field decreases due to the internal front-end. Significant signal change is indicated by the status bits.

2) With increasing speed, the distance between two samples increases. The travelling distance between two subsequent samples can be calculated as:

$$\text{sampling_dist} = \frac{v}{f_s}$$

where:

sampling_distance = travelling distance between samples (in mm)

v = travelling speed (in mm/sec)

f_s = sampling rate in Hz (see Table 9)



6.4 Electrical System Specifications

Table 9. Electrical System Specifications

Symbol	Parameter	Note	Min	Typ	Max	Units
RES _{abs}	Resolution, absolute outputs	0.488 $\mu\text{m}/\text{step}$ (12bit / 2mm pole pair)	12			bit / polepair
RES _{inc}	Resolution, incremental outputs	1.95 $\mu\text{m}/\text{step}$ (10bit / 2mm pole pair)	10			bit / polepair
INL _{opt}	Integral non-linearity (optimum)	Maximum error with respect to the best line fit. Ideal magnet T _{AMB} = 25 °C.			± 5.6	μm
INL _{temp}	Integral non-linearity (over temperature)	Maximum error with respect to the best line fit. Ideal magnet T _{amb} = -30 to +70 °C.			± 10	μm
DNL	Differential non-linearity	10bit, no missing codes			± 0.97	μm
TN	Transition noise	1 sigma			0.6	μm RMS
V _{on}	Power-on reset thresholds: On voltage; 300mV typ. hysteresis	DC supply voltage 3.3V (VDD3V3)	1.37	2.2	2.9	V
V _{off}	Power-on reset thresholds: Off voltage; 300mV typ. hysteresis		1.08	1.9	2.6	
t _{PwrUp}	Power-up time	Until status bit OCF = 1			20	ms
t _{delay}	System propagation delay absolute output	Delay of ADC, DSP and absolute interface			96	μs
t _{delay}	System propagation delay incremental output	Including interpolation delay at high speeds			384	μs
f _s	Internal sampling rate for absolute output	T _{AMB} = 25 °C	9.90	10.42	10.94	kHz
		T _{AMB} = -40 to +125 °C,	9.38	10.42	11.46	
Hyst	Hysteresis, incremental outputs	No Hysteresis at absolute serial outputs		2		LSB
CLK	Read-out frequency	Maximum clock frequency to read out serial data			1	MHz

Notes:

1. Integral Non-Linearity (INL) is the maximum deviation between actual position and indicated position.
2. Differential Non-Linearity (DNL) is the maximum deviation of the step length from one position to the next.
3. Transition Noise (TN) is the repeatability of an indicated position.



6.5 Timing Characteristics

Table 10. Synchronous Serial Interface (SSI)

Symbol	Parameter	Note	Min	Typ	Max	Units
$t_{DOactive}$	Data output activated (logic high)	Time between falling edge of CSn and data output activated			100	ns
t_{CLKFE}	First data shifted to output register	Time between falling edge of CSn and first falling edge of CLK	500			ns
$T_{CLK/2}$	Start of data output	Rising edge of CLK shifts out one bit at a time	500			ns
t_{Dvalid}	Data output valid	Time between rising edge of CLK and data output valid			413	ns
$t_{Dtristate}$	Data output tristate	After the last bit DO changes back to "tristate"			100	ns
t_{CSn}	Pulse width of CSn	CSn = high; To initiate read-out of next angular position	500			ns
f_{CLK}	Read-out frequency	Clock frequency to read out serial data	>0		1	MHz

6.5.1 Pulse Width Modulation Output

Table 11. Pulse Width Modulation Output

Symbol	Parameter	Note	Min	Typ	Max	Units
f_{PWM}	PWM frequency	Signal period = $4098\mu s \pm 5\%$ at $T_{AMB} = 25^{\circ}C$	232	244	256	Hz
		Signal period = $4098\mu s \pm 10\%$ at $T_{AMB} = -40$ to $+125^{\circ}C$	220	244	268	
PW_{MIN}	Minimum pulse width	Position 0d = $0\mu m$	0.9	1	1.1	μs
PW_{MAX}	Maximum pulse width	Position 4095d = $1999.5\mu m$	3892	4097	4301	μs



7 Detailed Description

The different types of outputs relative to the magnet position are outlined in [Figure 3](#) below.

The absolute serial output counts from 0...4095 within one pole pair and repeats with each subsequent pole pair.

Likewise, the PWM output starts with a pulse width of 1 μ s, increases the pulse width with every step of 0.488 μ m and reaches a maximum pulse width of 4097 μ s at the end of each pole pair.

An index pulse is generated once for every pole pair.

256 incremental pulses are generated at each output A and B for every pole pair. The outputs A and B are phase shifted by 90 electrical degrees, which results in 1024 edges per pole pair. As the incremental outputs are also repeated with every pole pair, a constant train of pulses is generated as the magnet moves over the chip.

Figure 3. AS5311 Outputs Relative to Magnet Position

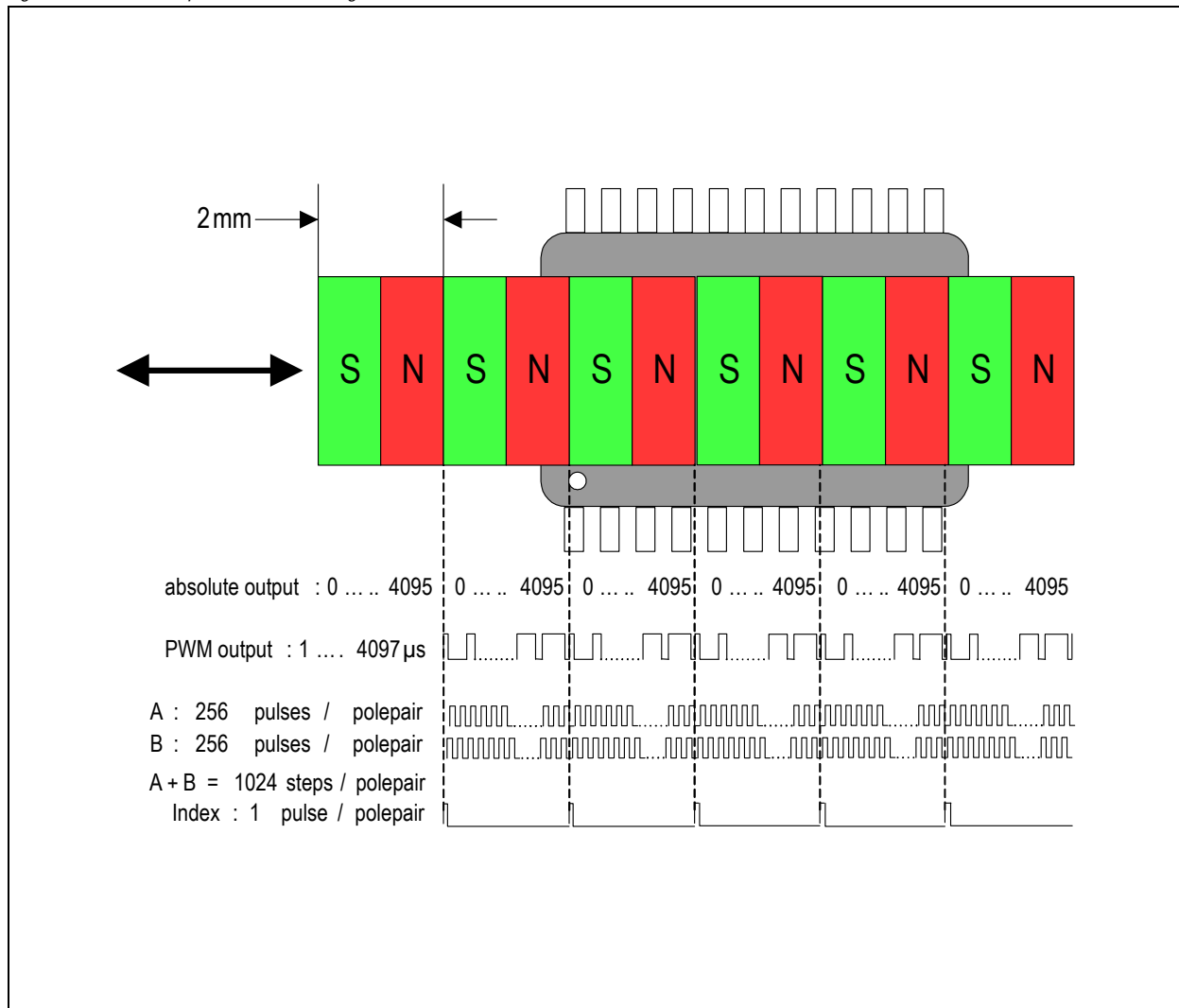



7.1 Incremental Outputs

Figure 4 shows the two-channel quadrature output of the AS5311. Output A leads output B when the magnet is moving from right to left and output B leads output A when the magnet is moving from left to right (see Figure 14).

Figure 4. Incremental Outputs

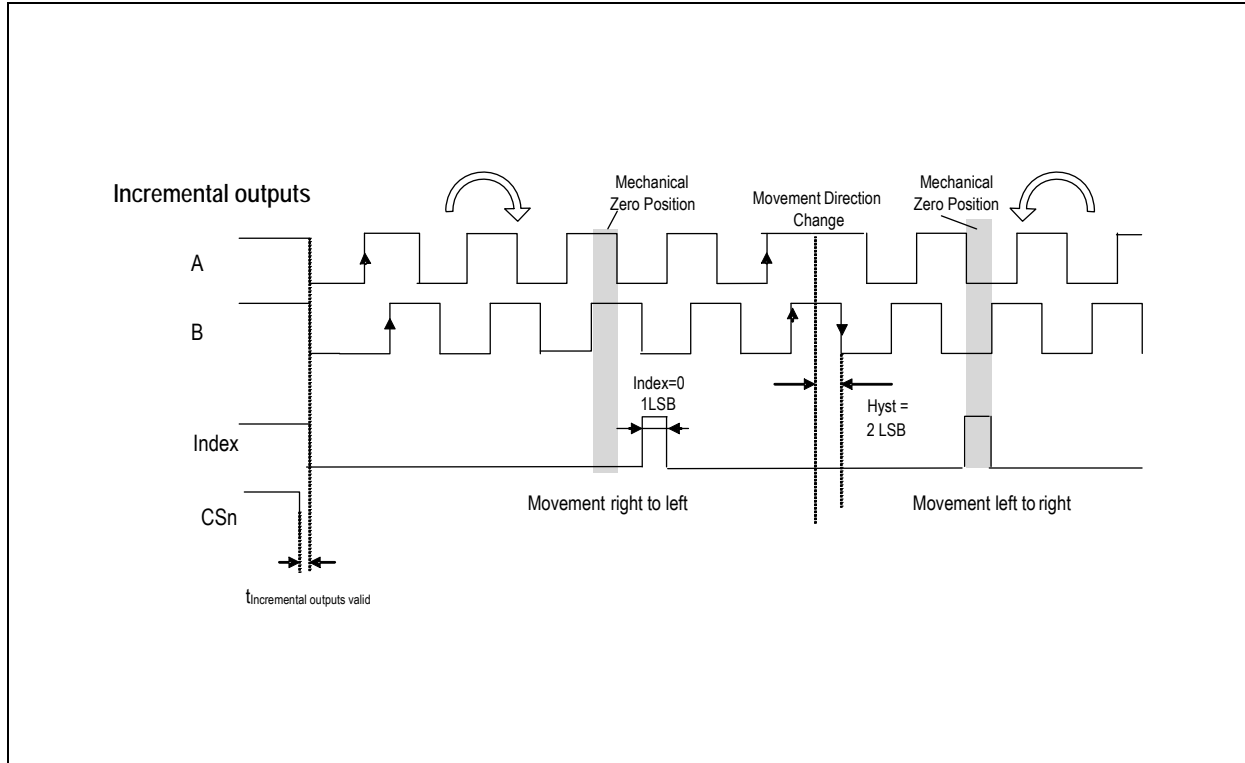

7.1.1 Incremental Power-up Lock Option

After power-up, the incremental outputs can optionally be locked or unlocked, depending on the status of the CSn pin:

CSn = low at power-up: CSn has an internal pull-up resistor and must be externally pulled low ($R_{ext} \leq 5k\Omega$). If CSn is low at power-up, the incremental outputs A, B and Index will be high until the internal offset compensation is finished. This unique state may be used as an indicator for the external controller to shorten the waiting time at power-up. Instead of waiting for the specified maximum power up-time (see [Electrical System Specifications on page 8](#)), the controller can start requesting data from the AS5311 as soon as the state (A= B= Index = high) is cleared.

CSn = high or open at power-up: In this mode, the incremental outputs (A, B, Index) will remain at logic high state after power-up, until CSn goes low or a low pulse is applied at CSn and internal offset compensation is finished. This mode allows intentional disabling of the incremental outputs after power-up until for example the system microcontroller is ready to receive data.

Once the incremental outputs are unlocked they can not be disabled during operation.



7.2 Incremental Output Hysteresis

Figure 5. Hysteresis Illustration

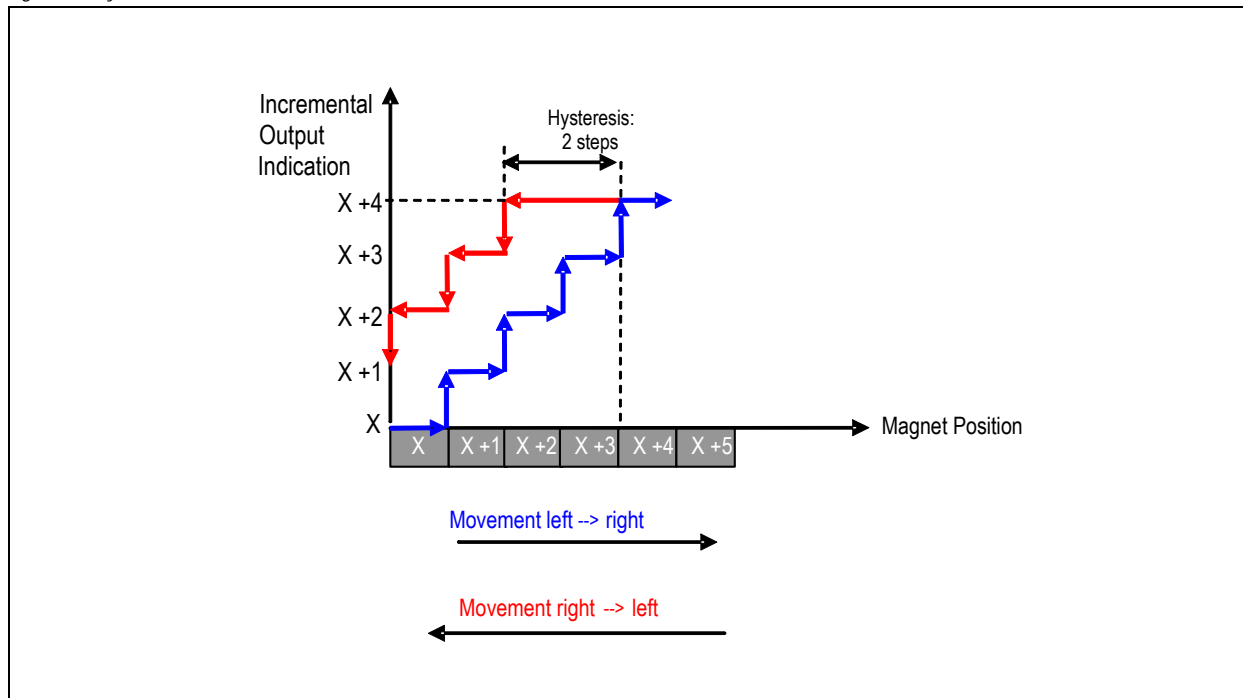

To avoid flickering incremental outputs at a stationary magnet position, a hysteresis is introduced.

In case of a movement direction change, the incremental outputs have a hysteresis of 2 LSB. For constant movement directions, every magnet position change is indicated at the incremental outputs (see Figure 4). If for example the magnet moves from position "x+3" to "x+4", the incremental output would also indicate this position accordingly.

A change of the magnet's movement direction back to position "x+3" means, that the incremental output still remains unchanged for the duration of 2 LSB, until position "x+2" is reached. Following this movement, the incremental outputs will again be updated with every change of the magnet position.

7.3 Synchronous Serial Interface (SSI)

The Serial interface allows data transmission of the 12-bit absolute linear position information (within one pole pair = 2.0mm). Data bits D11:D0 represent the position information with a resolution of 488nm (2000 μ m / 4096) per step. CLK must be high at the falling edge of CSn.

Figure 6. Synchronous Serial Interface with Absolute Angular Position Data

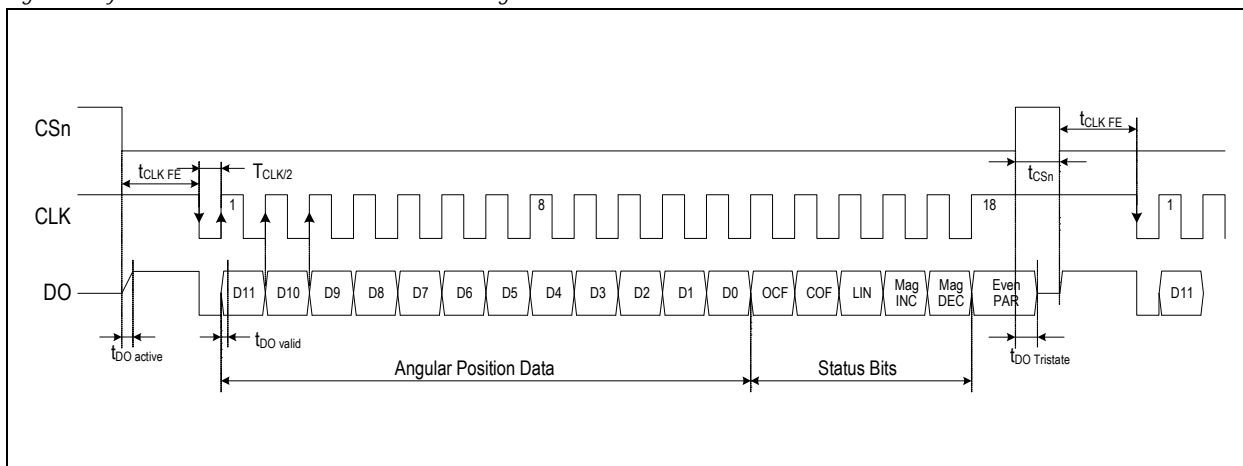



If CLK is low at the falling edge of CSn, the first 12 bits represent the magnitude information, which is proportional to the magnetic field strength. This information can be used to detect the presence and proper distance of the magnetic strip by comparing it to a known good value (depends on the magnet material and distance).

The automatic gain control (AGC) maintains a constant MAGnitude value of 3F hex (=“green” range). If the MAG value is <>3F hex, the AGC is out of the regulating range (“yellow” or “red” range). See [Table 13](#) for more details. For AGC algorithm only M11: M4 of the magnitude are used.

A value of zero or close to zero indicates a missing magnet.

Figure 7. Synchronous Serial Interface with Magnetic Field Strength Data

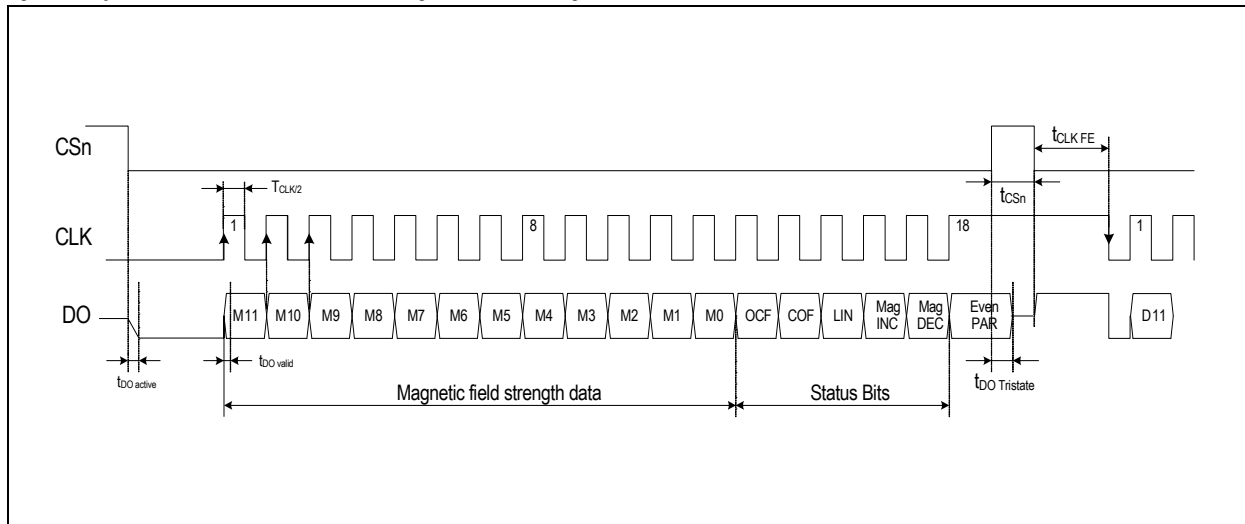

If CSn changes to logic low, Data Out (DO) will change from high impedance (tri-state) to logic high and the read-out will be initiated.

- After a minimum time $t_{CLK FE}$, data is latched into the output shift register with the first falling edge of CLK.
- Each subsequent rising CLK edge shifts out one bit of data.
- The serial word contains 18 bits, if CLK is high at the falling edge of CSn (see [Figure 6](#)), the first 12 bits are the absolute distance information D[11:0], the subsequent 6 bits contain system information, about the validity of data such as OCF, COF, LIN, Parity and Magnetic Field status (increase/decrease).
- If CLK is low at the falling edge of CSn, the first 12 bits contain the magnitude information and the subsequent bits contain the status bits (see [Figure 7](#)).
- A subsequent measurement is initiated by a “high” pulse at CSn with a minimum duration of t_{CSn} .

Data Contents:

D11:D0 absolute linear position data (MSB is clocked out first)

M11:M0 magnitude / magnetic field strength information (MSB is clocked out first)

OCF (Offset Compensation Finished), logic high indicates the finished Offset Compensation Algorithm. If this bit is not set, the data at D11:D0 (likewise M11:M0) may be invalid.

COF (Cordic Overflow), logic high indicates an out of range error in the CORDIC part. When this bit is set, the data at D11:D0 (likewise M11:M0) is invalid.

This alarm may be resolved by bringing the magnet within the X-Y-Z tolerance limits.

LIN (Linearity Alarm), logic high indicates that the input field generates a critical output linearity.

When this bit is set, the data at D11:D0 may still be used, but can contain invalid data. This warning can be resolved by increasing the magnetic field strength.

Even Parity bit for transmission error detection of bits 1...17 (D11...D0, OCF, COF, LIN, MagINC, MagDEC)



Data D11:D0 is valid, when the status bits have the following configurations:

Table 12. Status Bit Outputs

OCF	COF	LIN	MagINC	MagDEC	Parity
1	0	0	0	0	Even checksum of bits 1:17
			0	1	
			1	0	
			1*	1*	

*MagInc=MagDec=1 is only recommended in YELLOW mode (see Table 13).

7.4 Absolute Output Jitter and Hysteresis

Note: There is no hysteresis or additional filtering at the absolute output. This allows a determination of the magnet's absolute position within one pole pair down to submicron range.

Due to the intentionally omitted hysteresis and due to noise (e.g. from weak magnetic fields), the absolute output may jitter when the magnet is stationary over the chip. In order to get a stable 12-bit absolute reading, two common methods may be implemented to reduce the jitter.

7.4.1 Adding a Digital Hysteresis

The hysteresis feature of the incremental outputs is described in [Incremental Output Hysteresis](#). An equivalent function can be implemented in the software of the external microcontroller. The hysteresis should be larger than the peak-to-peak noise (=jitter) of the absolute output in order to mask it and create a stable output reading.

Note: The 2-bit hysteresis on the incremental output (=3.9µm) is equivalent to a hysteresis of 8LSB on the absolute output.

7.4.2 Implementing Digital Filtering

Another useful alternative or additional method to reduce jitter is digital filtering. This can be accomplished simply by averaging, for example a moving average calculation in the external microcontroller. Averaging 4 readings results in 6dB (=50%) noise and jitter reduction. An average of 16 readings reduces the jitter by a factor of 4.

Averaging causes additional latency of the processed data. Therefore it may be useful to adjust the depth of averaging depending on speed of travel. For example using a larger depth when the magnet is stationary and reducing the depth when the magnet is in motion.

7.5 Z-axis Range Indication ("Red/Yellow/Green" Indicator)

The AS5311 provides several options of detecting the magnet distance by indicating the strength of the magnetic field. The signal indicator pins MagINCn and MagDECn are available as hardware pins (pins 2 and 3) and display the "Red/Yellow/Green Range".

Additionally, the serial data stream (see [Figure 6](#)) offers the MagINC, MagDEC and LIN status bits. The LIN status bit indicates the non-recommended "red" range. The MAGnitude register provides additional information about the strength of the magnetic field (see [Figure 7](#)). For Z-axis Range Indication only M11:M4 of the magnitude are used.

The digital status bits MagINC, MagDec, LIN and the hardware pins MagINCn, MagDECn have the following function:

Table 13. Magnetic Field Strength Red-Yellow-Green Indicators

Status Bits			MAG	Hardware Pins ¹		Description
MagINC	MagDEC	LIN	M11...M4	MagINCn	MagDECn	
0	0	0	3F hex	Off	Off	No distance change Magnetic input field OK (GREEN range, ~10...40mT peak amplitude)
0	1	0	3F hex	Off	Off	Distance increase; this state is a dynamic state and only active while the magnet is moving away from the chip. Magnitude register may change but regulates back to 3F hex.
1	0	0	3F hex	Off	Off	Distance decrease; this state is a dynamic state and only active while the magnet is moving towards the chip. Magnitude register may change but regulates back to 3F hex.



Table 13. Magnetic Field Strength Red-Yellow-Green Indicators

Status Bits			MAG	Hardware Pins ¹		Description
MagINC	MagDEC	LIN	M11...M4	MagINCn	MagDECn	
1	1	0	20 hex- 5F hex	On	Off	YELLOW range: magnetic field is ~3.4...54.5mT. The AS5311 may still be operated in this range, but with slightly reduced accuracy.
1	1	1	<20 hex >5F hex	On	On	RED range: magnetic field is <3.4mT (MAG <20) or >54.5mT (MAG >5F). It is still possible to operate the AS5311 in the red range, but not recommended.
All other combinations				n/a	n/a	Not available

1. Pin 2 (MagINCn) and Pin 3 (MagDECn)

7.6 Pulse Width Modulation (PWM) Output

The AS5311 provides a pulse width modulated output (PWM), whose duty cycle is proportional to the relative linear position of the magnet within one pole pair (2.0mm). This cycle repeats after every subsequent pole pair:

(EQ 1)

$$Position = \frac{t_{on} \cdot 4098}{(t_{on} + t_{off})} - 1$$

for digital position = 0 – 4094

Exception: A linear position of 1999.5µm = digital position 4095 will generate a pulse width of $t_{on} = 4097\mu\text{s}$ and a pause $t_{off} = 1\mu\text{s}$

The PWM frequency is internally trimmed to an accuracy of $\pm 5\%$ ($\pm 10\%$ over full temperature range). This tolerance can be cancelled by measuring the complete duty cycle as shown above.



Figure 8. PWM Output Signal

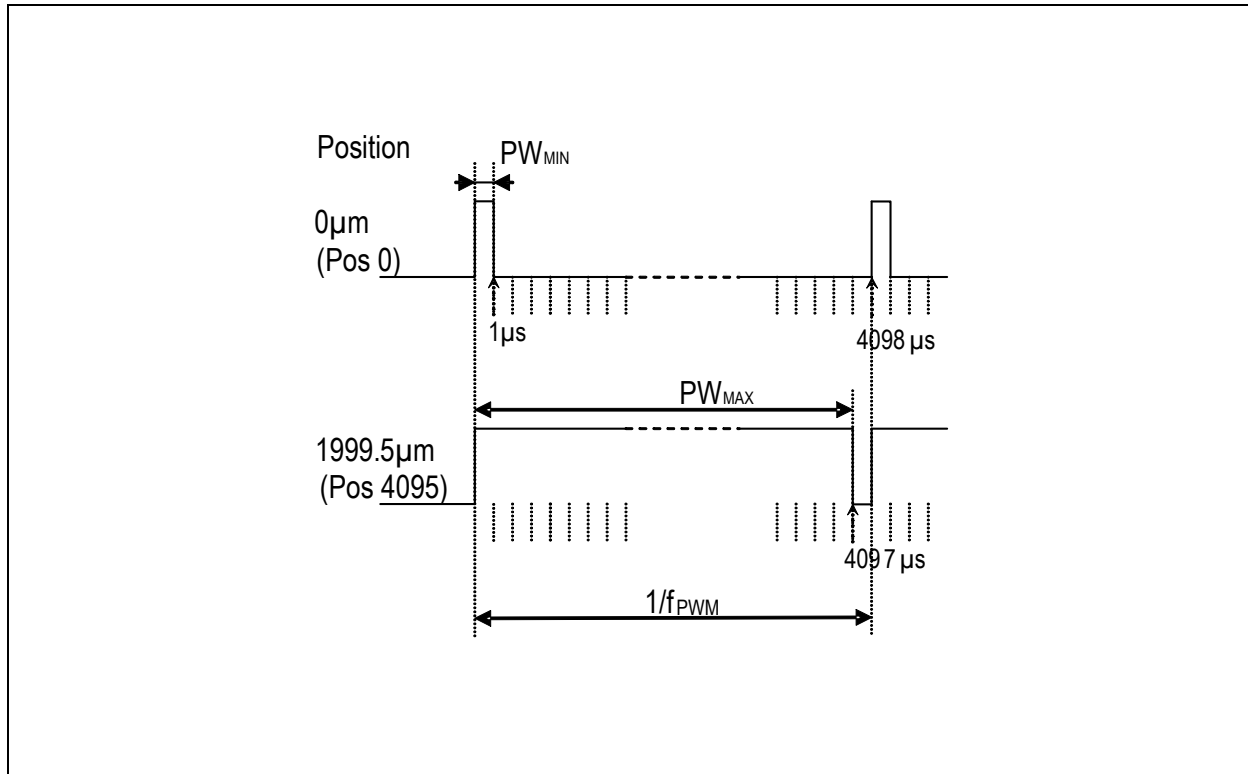

7.7 3.3V / 5V Operation

The AS5311 operates either at 3.3V \pm 10% or at 5V \pm 10%. This is made possible by an internal 3.3V Low-Dropout (LDO) Voltage regulator. The internal supply voltage is always taken from the output of the LDO, meaning that the internal blocks are always operating at 3.3V.

For 3.3V operation, the LDO must be bypassed by connecting VDD3V3 with VDD5V (see Figure 9).

For 5V operation, the 5V supply is connected to pin VDD5V, while VDD3V3 (LDO output) must be buffered by a 2.2...10 μ F capacitor, which is supposed to be placed close to the supply pin.

The VDD3V3 output is intended for internal use only. It must not be loaded with an external load.

The output voltage of the digital interface I/O's corresponds to the voltage at pin VDD5V, as the I/O buffers are supplied from this pin.

A buffer capacitor of 100nF is recommended in both cases close to pin VDD5V. Note that pin VDD3V3 must always be buffered by a capacitor. It must not be left floating, as this may cause an instable internal 3.3V supply voltage which may lead to larger than normal jitter of the measured angle.



Figure 9. Connections for 5V and 3.3V Supply Voltages

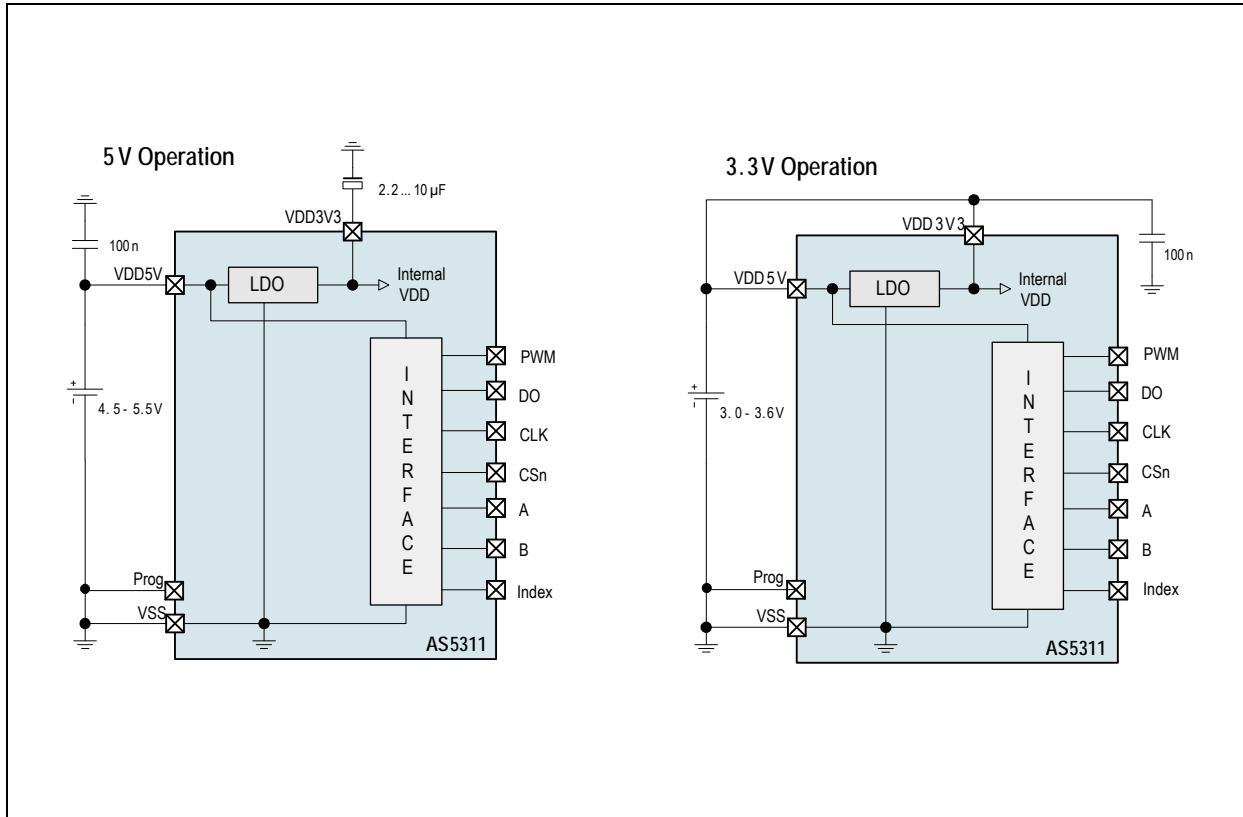



8 Application Information

Figure 10. AS5311 with Multi-pole Magnetic Strip for Linear Motion Sensing

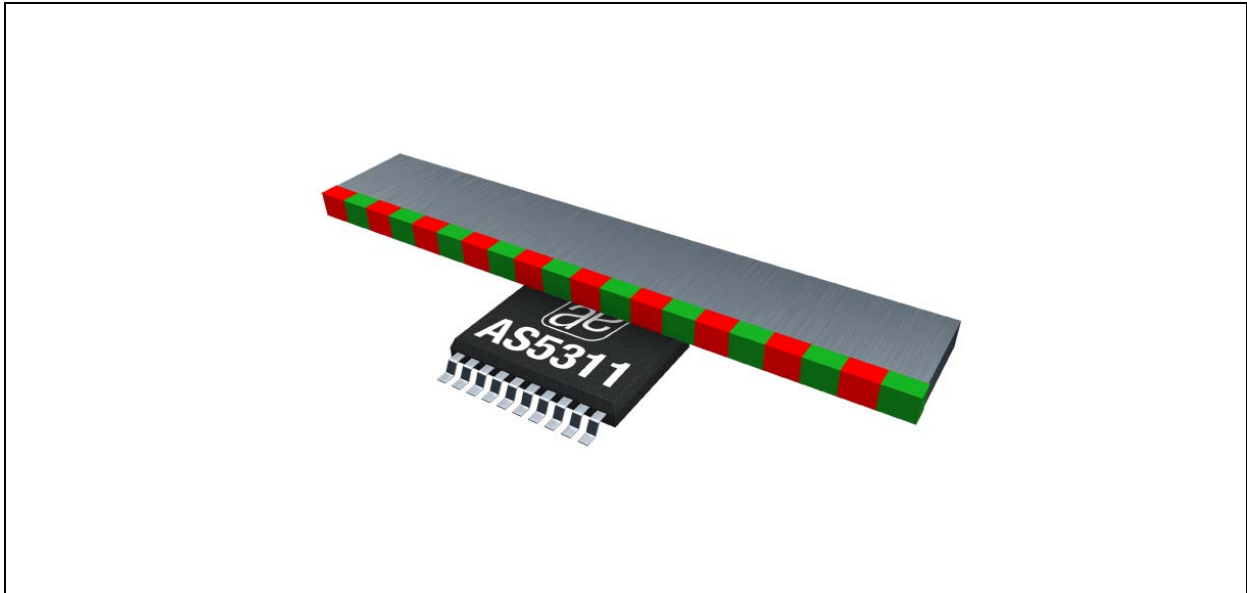
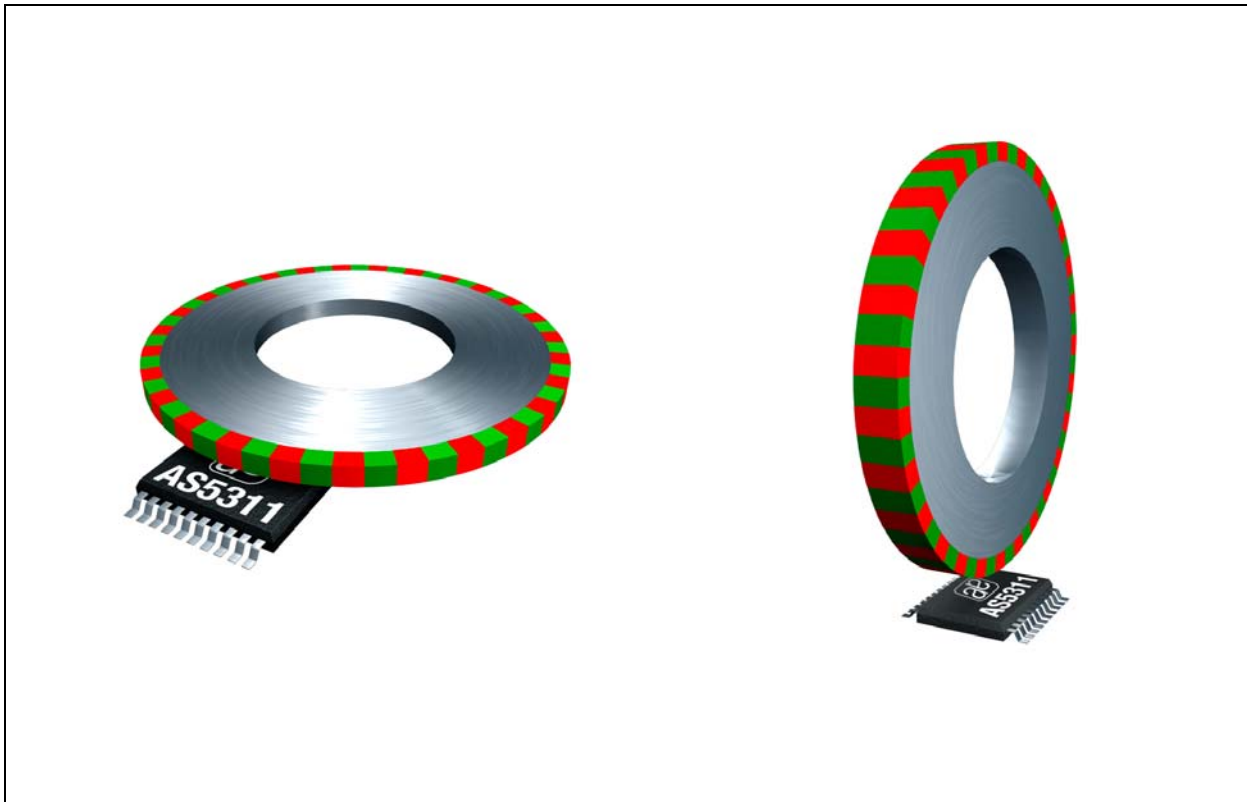

Figure 11. AS5311 with Multi-pole Ring Magnets for Off-axis Rotary Motion Sensing





8.1 Magnetization

The AS5311 accepts magnetic multi-pole strip or ring magnets with a pole length of 1.0mm. Recommended magnet materials include plastic or rubber bonded ferrite or Neodymium magnets.

It is not recommended to use the AS5311 with other pole lengths as this will create additional non-linearities.

Figure 12. Additional Error from Pole Length Mismatch

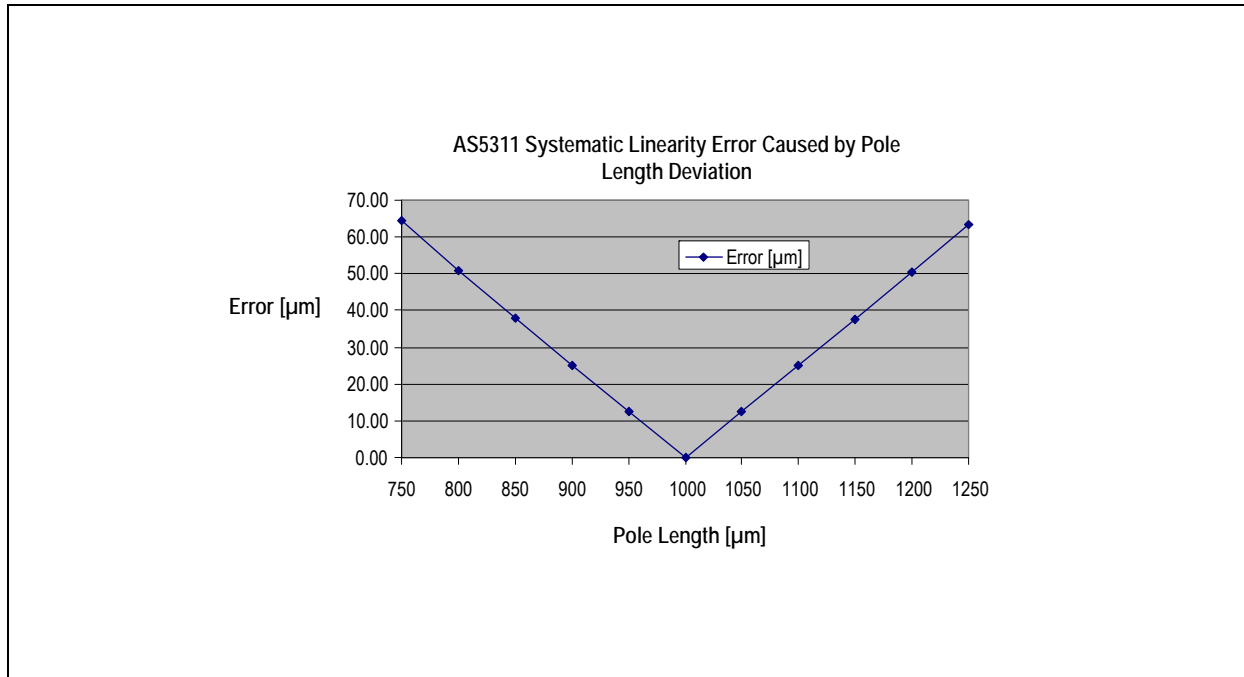

Figure 12 shows the error caused by a mismatch of pole length. Note that this error is an additional error on top of the chip-internal INL and DNL errors (see [Electrical System Specifications on page 8](#)). For example, when using a multi-pole magnet with 1.2mm pole length instead of 1.0mm, the AS5311 will provide 1024 incremental steps or 4096 absolute positions over 2.4mm, but with an additional linearity error of up to 50μm.

The curvature of ring magnets may cause linearity errors as well due to the fact that the Hall array on the chip is a straight line while the poles on the multi-pole ring are curved. These errors decrease with increasing ring diameter. It is therefore recommended to keep the ring diameter measured at the location of the Hall array at 20mm or higher.

8.2 Position of the Index Pulse

An index pulse is generated when the North and South poles are placed over the Hall array as shown in [Figure 14](#).

The incremental output count increases when the magnet is moving to the left, facing the chip with pin#1 at the lower left corner (see [Figure 14](#) - top drawing). At the same time, the absolute position value increases. Likewise, the position value decreases when the magnet is moved in the opposite direction.



8.3 Mounting the Magnet

8.3.1 Vertical Distance

As a rule of thumb, the gap between chip and magnet should be $\frac{1}{2}$ of the pole length, that is $Z=0.5\text{mm}$ for the 1.0mm pole length of the AS5311 magnets. However, the gap also depends on the strength of the magnet. Typical gaps for AS5311 magnets range from 0.3 to 0.6mm (see [Electrical System Specifications on page 8](#)).

The AS5311 automatically adjusts for fluctuating magnet strength by using an automatic gain control (AGC). The vertical distance should be set such that the AS5311 is in the “green” range. See [Z-axis Range Indication \(“Red/Yellow/Green” Indicator\) on page 14](#) for more details.

8.3.2 Alignment of Multi-pole Magnet and IC

When aligning the magnet strip or ring to the AS5311, the centerline of the magnet strip should be placed exactly over the Hall array. A lateral displacement in Y-direction (across the width of the magnet) is acceptable as long as it is within the active area of the magnet. See [Figure 14](#) for the position of the Hall array relative to Pin #1.

Note: The active area in width is the area in which the magnetic field strength across the width of the magnet is constant with reference to the centerline of the magnet (see [Figure 13](#)).

8.3.3 Lateral Stroke of Multi-pole Strip Magnets

The lateral movement range (stroke) is limited by the area at which all Hall sensors of the IC are covered by the magnet in either direction. The Hall array on the AS5311 has a length of 2.0mm, hence the total stroke is,

$$\text{maximum lateral Stroke} = \text{Length of active area} - \text{length of Hall array} \quad (\text{EQ } 2)$$

Note: Active area in length is defined as the area containing poles with the specified 1.0mm pole length. Shorter poles at either edge of the magnet must be excluded from the active area (see [Figure 13](#)).

Figure 13. Active Area of Strip Magnet

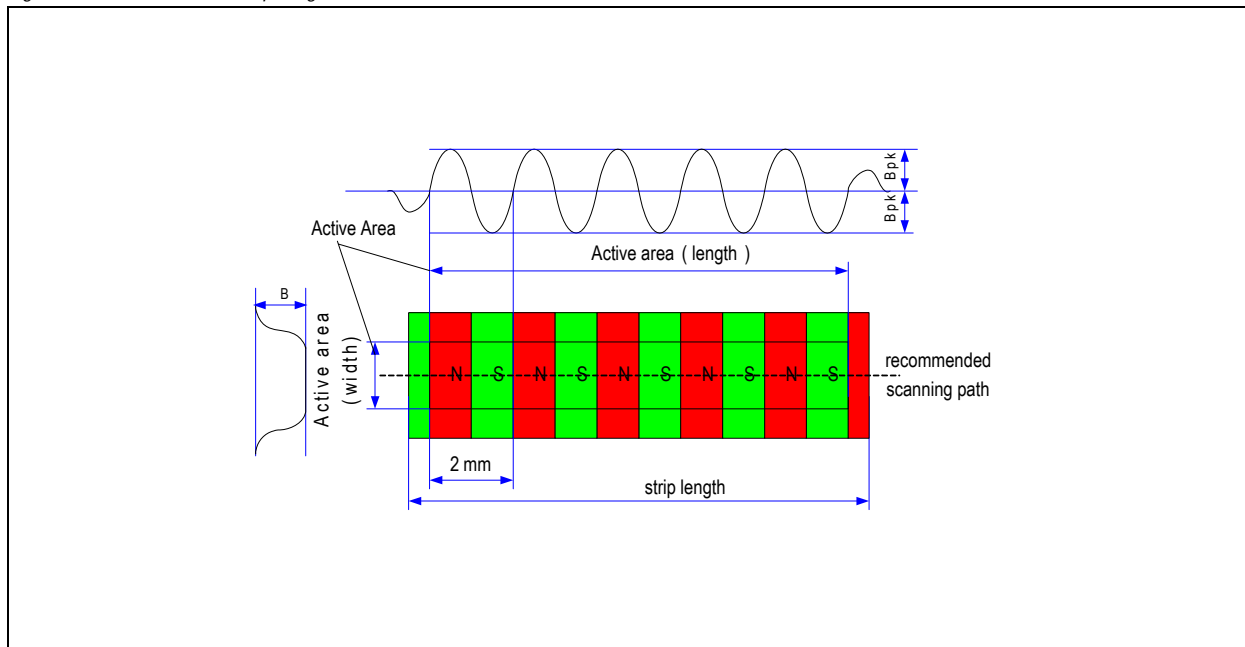
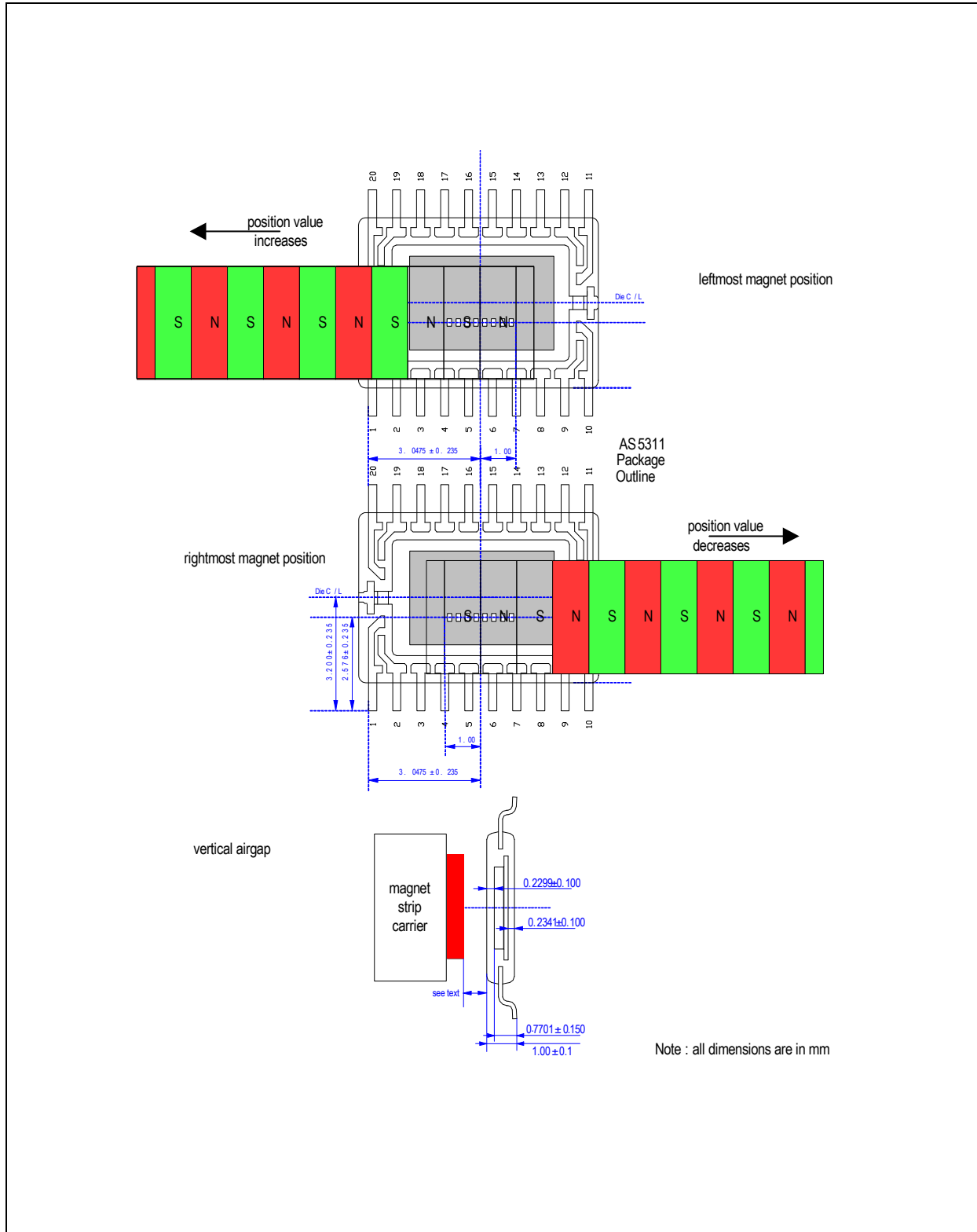



Figure 14. Alignment of Magnet Strip with AS5311 Sensor IC





8.4 Measurement Data Example

Figure 15 shows typical test results of the accuracy obtained by a commercially available multi-pole magnetic strip.

The graph shows the accuracy over a stroke of 8mm at two different vertical gaps, 0.2mm and 0.4mm. As displayed, the accuracy is virtually identical (about $\pm 10\mu\text{m}$) for both airgaps due to the automatic gain control of the AS5311 which compensates for airgap changes.

The accuracy depends greatly on the length and strength of each pole and hence from the precision of the tool used for magnetization as well as the homogeneity of the magnet material. As the error curve in the example below does not show a repetitive pattern for each pole pair (each 2.0mm), this is most likely an indication that the pole lengths of this particular sample do not exactly match. While the first pole pair (0...2mm) shows the greatest non-linearities, the second pole (2...4mm) is very precise, etc.

Figure 15. Sample Test Results of INL at Different Airgaps

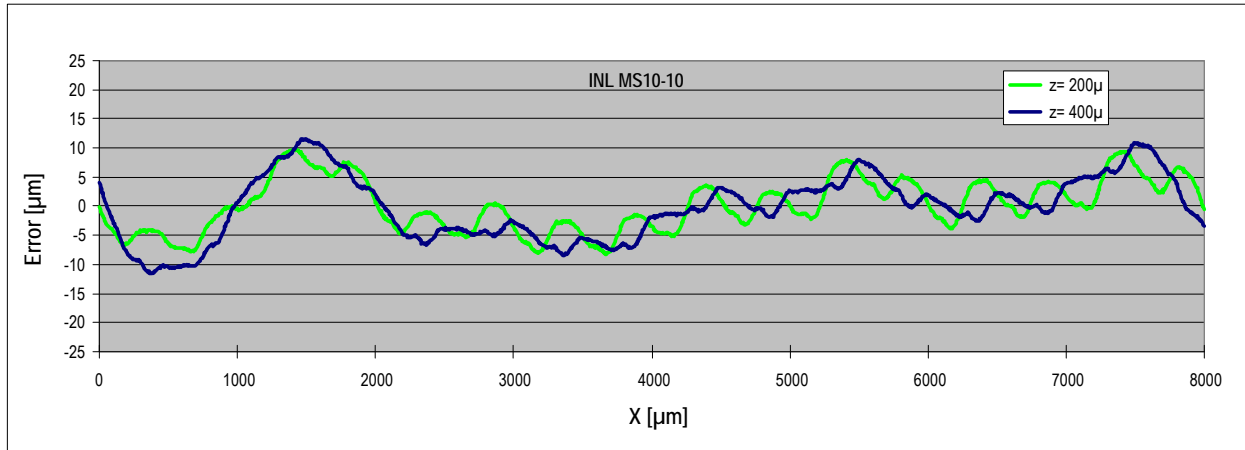

Note: The magnet sample used in Figure 15 is a 10-pole plastic bonded ferrite magnet as shown in Figure 13. The corresponding magnet datasheet (MS10-10) is available for download from the *ams* website, magnet samples can be ordered from the *ams* online web shop.



8.5 AS5311 Off-axis Rotary Applications

The AS5311 can also be used as an off-axis rotary encoder, as shown in Figure 11. In such applications, the multi-pole magnetic strip is replaced by a multi-pole magnetic ring. The ring can have radial or axial magnetization.

Figure 16. Angular Resolution and Maximum Speed vs. Ring Diameter

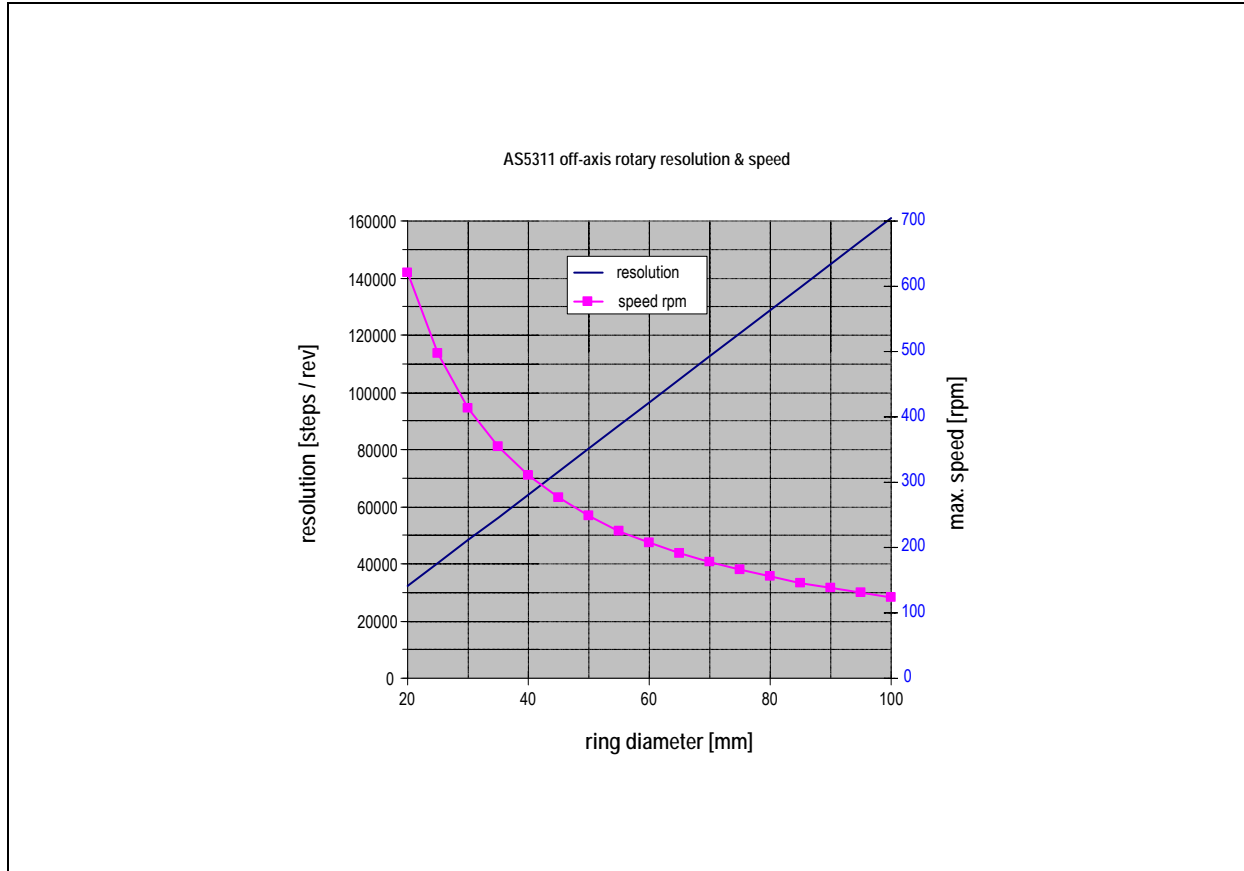

In off-axis rotary applications, very high angular resolutions are possible with the AS5311.

The number of steps per revolution increases linearly with ring diameter.

Due to the increasing number of pulses per revolution, the maximum speed decreases with increasing ring diameter.

Example: A magnetic ring with 41.7mm diameter has a resolution of 65536 steps per revolution (16-bit) and a maximum speed of 305 rpm.

Res [bit]	Steps per Revolution	Ring Diameter [mm]	Maximum Speed [rpm]
15	32768	20.9	609
16	65536	41.7	305
17	131072	83.4	152



The number of incremental steps per revolution can be calculated as:

(EQ 3)

$$\text{incremental_steps} = 1024 * \text{nbr_polepairs}$$

(EQ 4)

$$\text{incremental_steps} = \frac{1024 * d * \pi}{2}$$

Note: The circumference ($d * \pi$) must be a multiple of one polepair = 2mm, hence the diameter of the magnet ring may need to be adjusted accordingly:

(EQ 5)

$$d = \frac{\text{nbr_polepairs} * 2\text{mm}}{\pi}$$

The maximum rotational speed can be calculated as:

(EQ 6)

$$\text{max_rot_speed} = \frac{\text{max_lin_speed} * 60}{d * \pi} = \frac{39000}{d * \pi}$$

Where:

nbr_polepairs is the number of pole pairs at the magnet ring.

d is the diameter of the ring in mm; the diameter is taken at the locus of the Hall elements underneath the magnet.

max_rot_speed is the maximum rotational speed in revolutions per minute rpm.

max_lin_speed is the maximum linear speed in mm/sec (=650 mm/s for AS5311).

Note: Further examples are shown in the "Magnet Selection Guide", available for download from the *ams* website.



9 Package Drawings and Markings

The device is available in a 20-pin TSSOP package.

Figure 17. 20-pin TSSOP Package Dimensions and Hall Array Location

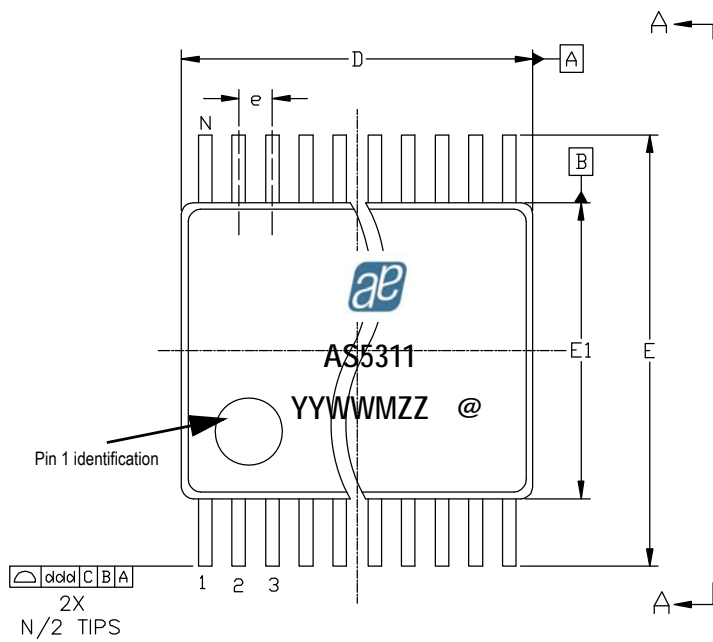

Symbol	Min	Nom	Max
A	-	-	1.20
A1	0.05	-	0.15
A2	0.80	1.00	1.05
b	0.19	-	0.30
c	0.09	-	0.20
D	6.40	6.50	6.60
E	-	6.40 BSC	-
E1	4.30	4.40	4.50
e	-	0.65 BSC	-
L	0.45	0.60	0.75
L1	-	1.00 REF	-
R	0.09	-	-
R1	0.09	-	-
S	0.20	-	-
$\theta 1$	0°	-	8°
$\theta 2$	-	12 REF	-
$\theta 3$	-	12 REF	-
aaa	-	0.10	-
bbb	-	0.10	-
ccc	-	0.05	-
ddd	-	0.20	-
N	20		

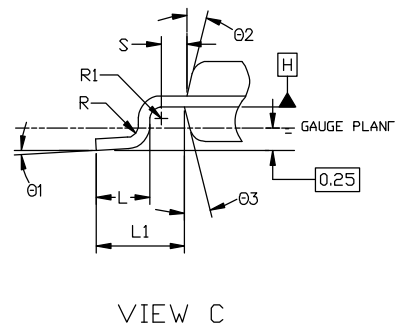
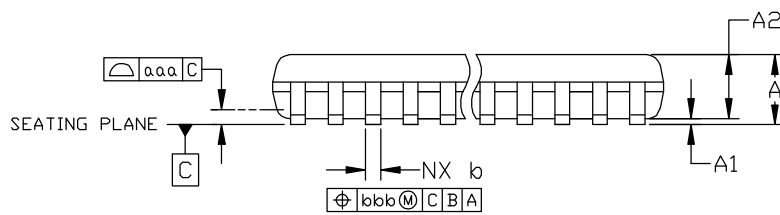
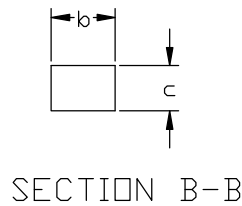
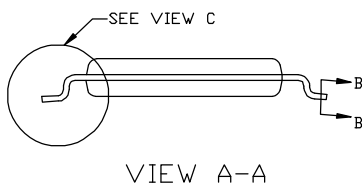

Notes:

1. Dimensions & Tolerancing conform to ASME Y14.5M-1994.
2. All dimensions are in millimeters. Angles are in degrees.





Marking: YYWWMZZ.

YY	WW	M	ZZ	@
Year	Manufacturing Week	Plant Identifier	Traceability Code	Sublot Identifier

Note: IC's marked with a white dot or the letters "ES" denote Engineering Samples.

JEDEC Package Outline Standard: MO - 153

Thermal Resistance $R_{th(j-a)}$: 89 K/W in still air, soldered on PCB

9.1 Recommended PCB Footprint

Figure 18. PCB Footprint

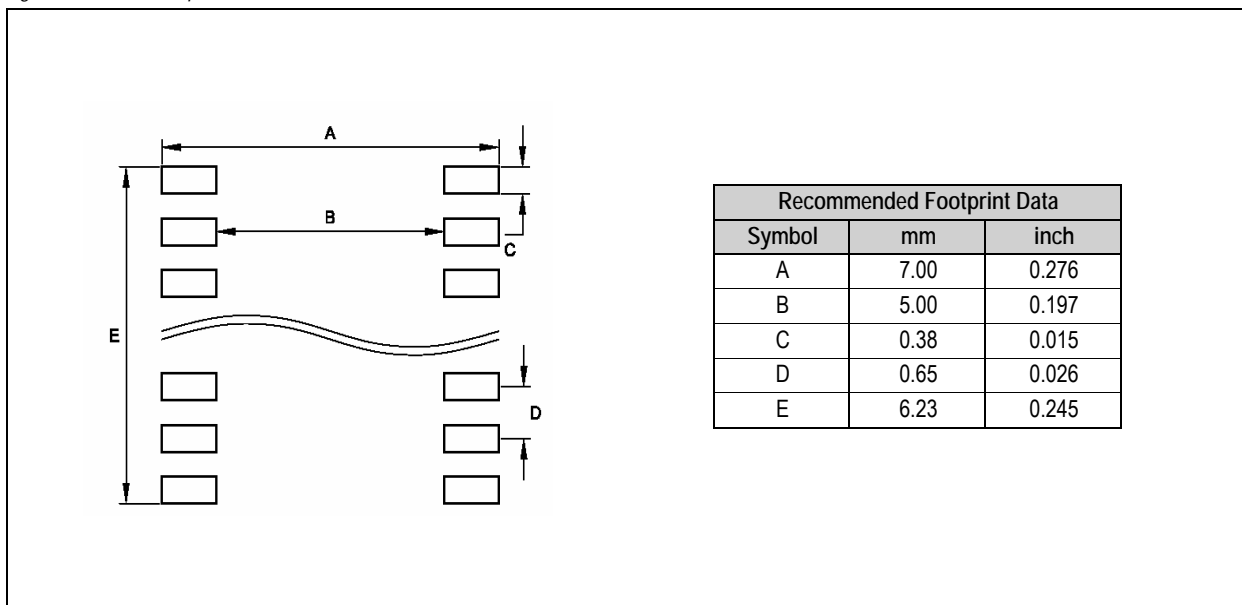



Revision History

Revision	Date	Owner	Description
1.1	26 Jun, 2009	jja / jlu	Recommended PCB Footprint (page 26) updated
1.2	09 Apr, 2010	agt	Ordering Information (page 28) updated
1.3	24 Sep, 2010		Updated Figure 7
1.6	08 Nov, 2011	rph	Added few lines in Magnetic Input Specification (page 7) and edited the footnote in Data Contents (page 13)
1.7	01 Mar, 2012		Updated Figure 7 and Section 7.1.1 and Section 7.3
1.8	12 Mar, 2012		Updated Package Drawings and Markings , Absolute Maximum Ratings , Figure 14 and Ordering Information
1.9	11 Apr, 2012		Updated Ordering Information , General Description and Pin Descriptions
1.10	13 Jun, 2012		Updated Section 7.5 and Table 1
1.11	21 Jun, 2012		Updated Table 2

Note: Typos may not be explicitly mentioned under revision history.



10 Ordering Information

The devices are available as the standard products shown in [Table 14](#).

Table 14. Ordering Information

Ordering Code	Description	Delivery Form	Package
AS5311-ATSU	1 box = 100 tubes à 74 devices	Tubes	20-pin TSSOP
AS5311-ATST	1 reel = 1000 devices 1 reel = 4500 devices	Tape & Reel	

Note: All products are RoHS compliant and ams green.
Buy our products or get free samples online at www.ams.com/ICdirect

Technical Support is available at www.ams.com/Technical-Support

For further information and requests, email us at sales@ams.com
(or) find your local distributor at www.ams.com/distributor



Copyrights

Copyright © 1997-2012, ams AG, Tobelbaderstrasse 30, 8141 Unterpemstaetten, Austria-Europe. Trademarks Registered ®. All rights reserved. The material herein may not be reproduced, adapted, merged, translated, stored, or used without the prior written consent of the copyright owner.

All products and companies mentioned are trademarks or registered trademarks of their respective companies.

Disclaimer

Devices sold by ams AG are covered by the warranty and patent indemnification provisions appearing in its Term of Sale. ams AG makes no warranty, express, statutory, implied, or by description regarding the information set forth herein or regarding the freedom of the described devices from patent infringement. ams AG reserves the right to change specifications and prices at any time and without notice. Therefore, prior to designing this product into a system, it is necessary to check with ams AG for current information. This product is intended for use in normal commercial applications. Applications requiring extended temperature range, unusual environmental requirements, or high reliability applications, such as military, medical life-support or life-sustaining equipment are specifically not recommended without additional processing by ams AG for each application. For shipments of less than 100 parts the manufacturing flow might show deviations from the standard production flow, such as test flow or test location.

The information furnished here by ams AG is believed to be correct and accurate. However, ams AG shall not be liable to recipient or any third party for any damages, including but not limited to personal injury, property damage, loss of profits, loss of use, interruption of business or indirect, special, incidental or consequential damages, of any kind, in connection with or arising out of the furnishing, performance or use of the technical data herein. No obligation or liability to recipient or any third party shall arise or flow out of ams AG rendering of technical or other services.



Contact Information

Headquarters

ams AG
Tobelbaderstrasse 30
A-8141 Unterpemstaetten, Austria

Tel : +43 (0) 3136 500 0
Fax : +43 (0) 3136 525 01

For Sales Offices, Distributors and Representatives, please visit:

<http://www.ams.com/contact>