

## Features

- Micropower operation
- Operation with North or South Pole
- 2.4 to 5.5V battery operation
- Chopper Stabilized
  - Superior temperature stability
  - Extremely Low Switch-Point Drift
  - Insensitive to Physical Stress
- Good RF noise immunity
- -40°C to 85°C operating temperature
- Low profile 3 pin SC59 (commonly known as SOT23 in Asia) and DFN2020-6 package
- ESD (HBM) > 4KV for DFN2020-6
- SC59 (commonly known as SOT23 in Asia) and DFN2020-6: Available in "Green" Molding Compound (No Br, Sb)
- Lead Free Finish/ RoHS Compliant (Note 1)

## General Description

AH1803 is with two Hall effect plates and a CMOS output driver, mainly designed for battery-operation, hand-held equipment (such as Cellular and Cordless Phone, PDA). The total operation power is down to 24uW in the 3V supply.

Either North or South Pole of sufficient strength will turn the output on. The output will be turned off under no magnetic field. While the magnetic flux density (**B**) is larger than operate point (**Bop**), the output will be turned on (low), the output is held until **B** is lower than release point (**Brp**), then turned off (High).

## Applications

- Cellular phone
- PDA
- Cordless phone

## Typical Circuit

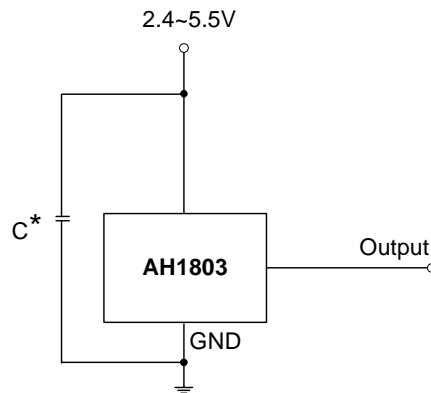

\* C is for power stabilization and to strengthen the noise immunity, the recommended capacitance is 10nF~100nF.

**Ordering Information**

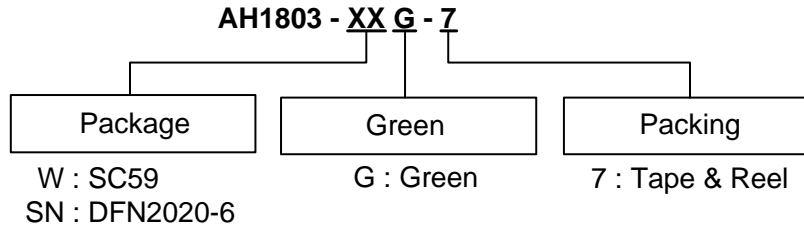

Product	Package Code	Packaging (Note 2)	7" Tape and Reel	
			Quantity	Part Number Suffix
AH1803-WG-7	W	SC59	3000/Tape & Reel	-7
AH1803-SNG-7	SN	DFN2020-6	3000/Tape & Reel	-7

Notes: 1. EU Directive 2002/95/EC (RoHS). All applicable RoHS exemptions applied. Please visit our website at [http://www.diodes.com/products/lead\\_free.html](http://www.diodes.com/products/lead_free.html).  
 2. Pad layout as shown on Diodes Inc. suggested pad layout document AP02001, which can be found on our website at <http://www.diodes.com/datasheets/ap02001.pdf>.

**Pin Assignments**

(1) SC59 (commonly known as SOT23 in Asia)

(2) DFN2020-6

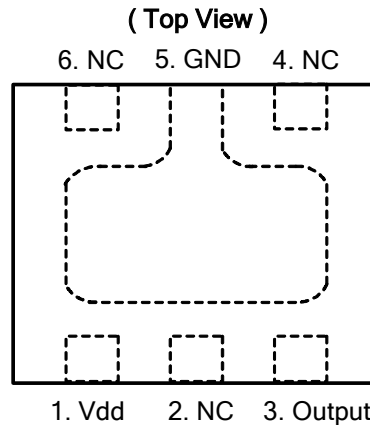
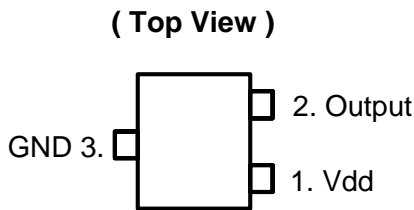

Notes: 3. NC is "No Connection", which is recommended to be tied to ground.

**Pin Descriptions**

Pin Name	P/I/O	Description
Vdd	P/I	Power Supply Input
GND	P/I	Ground
Output	O	Output Pin
NC		No Connected

## Block Diagram

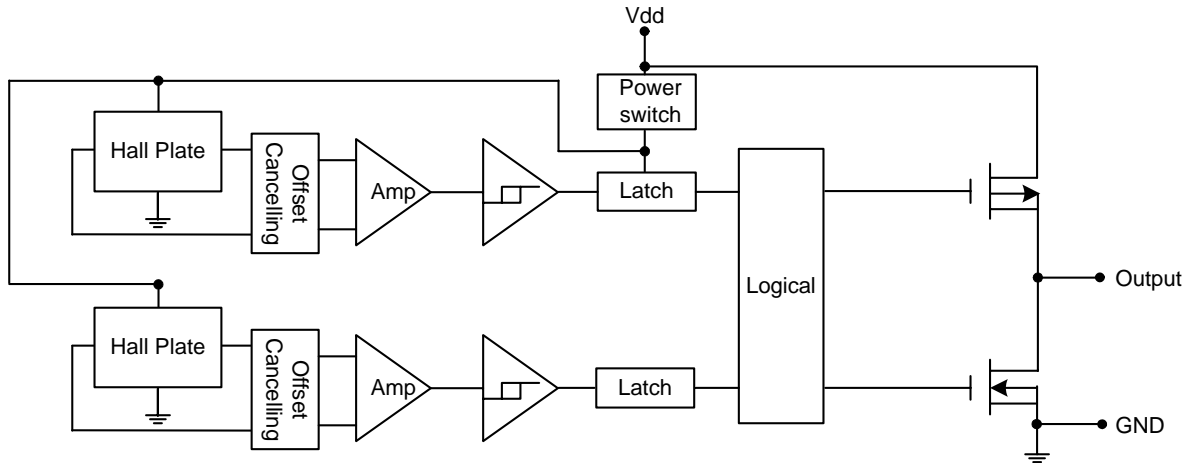

## Absolute Maximum Ratings (at $T_A = 25^\circ\text{C}$ )

Symbol	Characteristics	Values	Unit	
Vdd	Supply voltage	7	V	
B	Magnetic flux density	Unlimited		
Ts	Storage Temperature Range	-65 to +150	$^\circ\text{C}$	
P <sub>D</sub>	Package Power Dissipation	SC59	230	mW
		DFN2020-6	230	mW
T <sub>J</sub>	Maximum Junction Temperature	150	$^\circ\text{C}$	

## Recommended Operating Conditions ( $T_A = 25^\circ\text{C}$ )

Symbol	Parameter	Conditions	Rating	Unit
Vdd	Supply Voltage	Operating	2.4~5.5	V
T <sub>A</sub>	Operating Temperature Range	Operating	-40 to +85	$^\circ\text{C}$

**Electrical Characteristics** (TA= +25°C, Vdd= 3V; unless otherwise specified)

Symbol	Characteristic	Conditions	Min	Typ.	Max	Unit
V <sub>OH</sub>	Output On Voltage (High side)	I <sub>OUT</sub> = -1mA	V <sub>dd</sub> -0.2	-	-	V
V <sub>OL</sub>	Output On Voltage (Low side)	I <sub>OUT</sub> = 1mA	-	-	0.1	V
I <sub>dd(en)</sub>	Supply Current	Chip enable, T <sub>A</sub> = 25°C, V <sub>dd</sub> = 3V	-	3	6	mA
		Chip enable, T <sub>A</sub> = -40~85°C, V <sub>dd</sub> = 2.4~5.5V	-	3	9	mA
I <sub>dd(dis)</sub>		Chip disable, T <sub>A</sub> = 25°C, V <sub>dd</sub> = 3V	-	5	10	μA
		Chip disable, T <sub>A</sub> = -40~85°C, V <sub>dd</sub> = 2.4~5.5V	-	5	18	μA
I <sub>dd(avg)</sub>		Average supply current, T <sub>A</sub> = 25°C, V <sub>dd</sub> = 3V	-	8	16	μA
		Average supply current, T <sub>A</sub> = -40~85°C, V <sub>dd</sub> = 2.4~5.5V	-	8	27	μA
T <sub>awake</sub>	Awake Time	(Note 5)	-	75	150	μs
T <sub>period</sub>	Period	(Note 5)	-	75	150	ms
D.C.	Duty Cycle		-	0.1	-	%

Notes: 5. When power is initially on, the operating V<sub>dd</sub> (2.4V to 5.5V) must be applied to be guaranteed for the output sampling. The output state is valid after the second operating phase (typical 150ms).

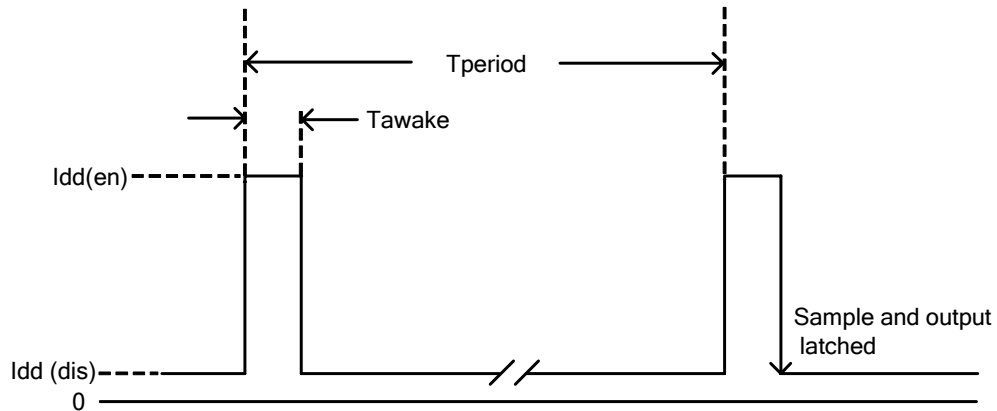

**Magnetic Characteristics** (TA = 25°C, Vdd = 3V, Note 6, 7)

(1mT = 10G)

Symbol	Parameter	Min	Typ.	Max	Unit
Bops(south pole to brand side)	Operation Point	2	3	4	mT
Bopn(north pole to brand side)		-4	-3	-2	
Brps(south pole to brand side)	Release Point	1	2	-	
Brpn(north pole to brand side)		-	-2	-1	
Bhy( Bopx - Brpx )	Hysteresis	0.5	1	-	

Notes: 6. Typical data is at TA=25 °C, Vdd=3V, and for design information only.  
7. Magnetic characteristics are for design information, which will vary with supply voltage, operating temperature and after soldering.

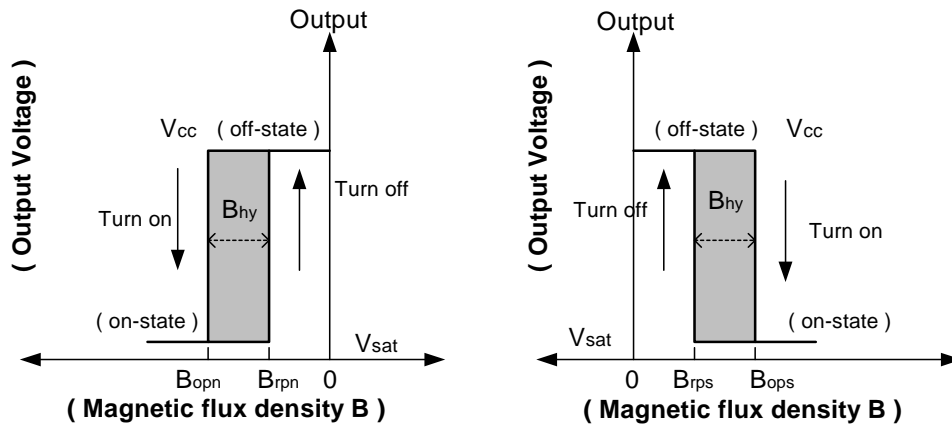

**Performance Characteristics**

(1) SC59 (commonly known as SOT23 in Asia) and DFN2020-6

TA (°C)	25	50	60	70	80	85	90	100	110	120	130	140	150
PD (mW)	230	184	166	147	129	120	110	92	74	55	37	18	0

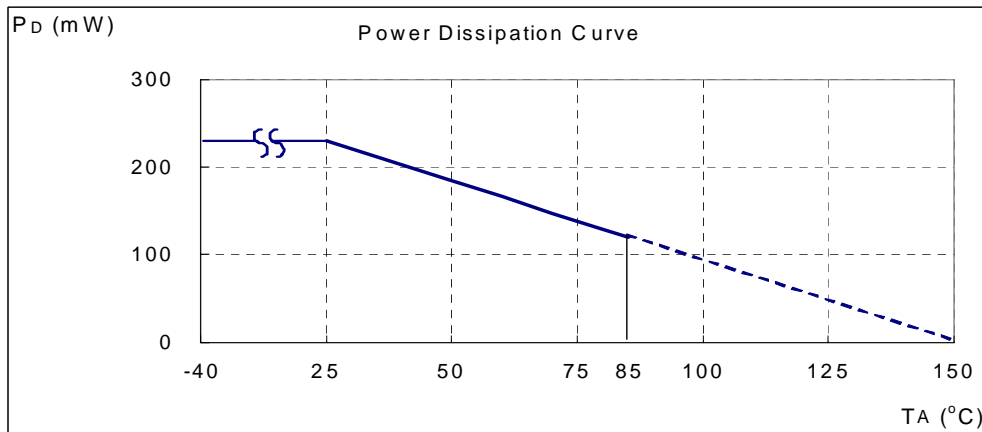

**Marking Information**

(1) SC59 (commonly known as SOT23 in Asia)

( Top View )

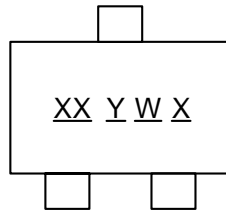

XX : Identification code  
Y : Year 0~9  
W : Week : A~Z : 1~26 week;  
a~z : 27~52 week; z represents  
52 and 53 week  
X : A~Z : Green

Part Number	Package	Identification Code
AH1803	SC59	KD

(2) DFN2020-6

( Top View )

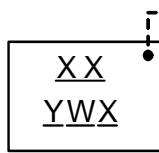

Pin 1 indicator  
XX : Identification Code  
Y : Year : 0~9  
W : Week : A~Z : 1~26 week;  
a~z : 27~52 week; z represents  
52 and 53 week  
X : A~Z : Green

Part Number	Package	Identification Code
AH1803	DFN2020-6	KD

**Package Information** (All Dimensions in mm)

**(1) Package Type: SC59 (commonly known as SOT23 in Asia)**

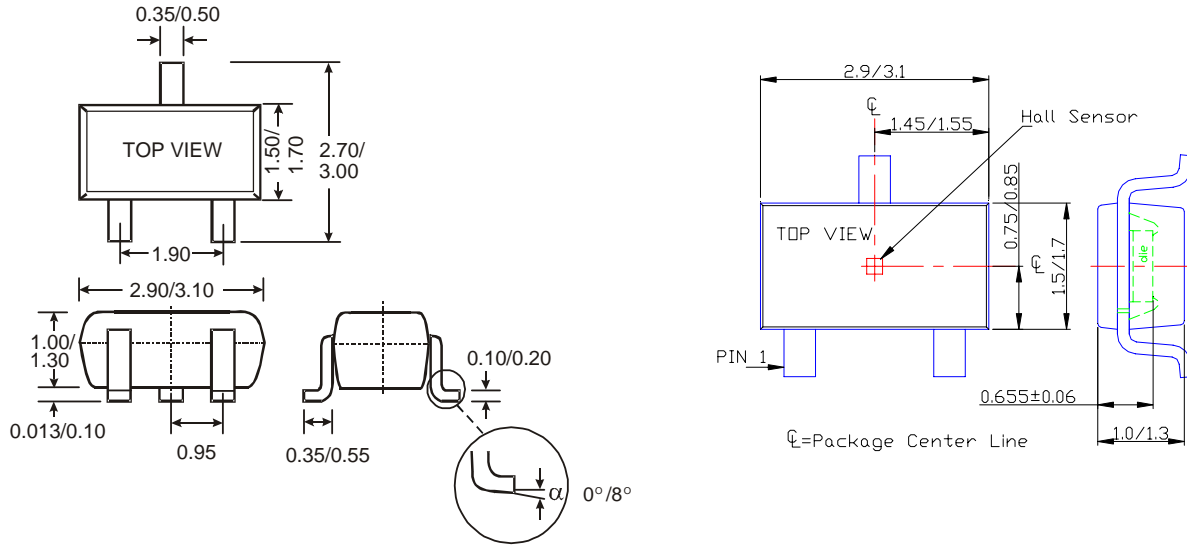

**(2) Package Type: DFN2020-6**

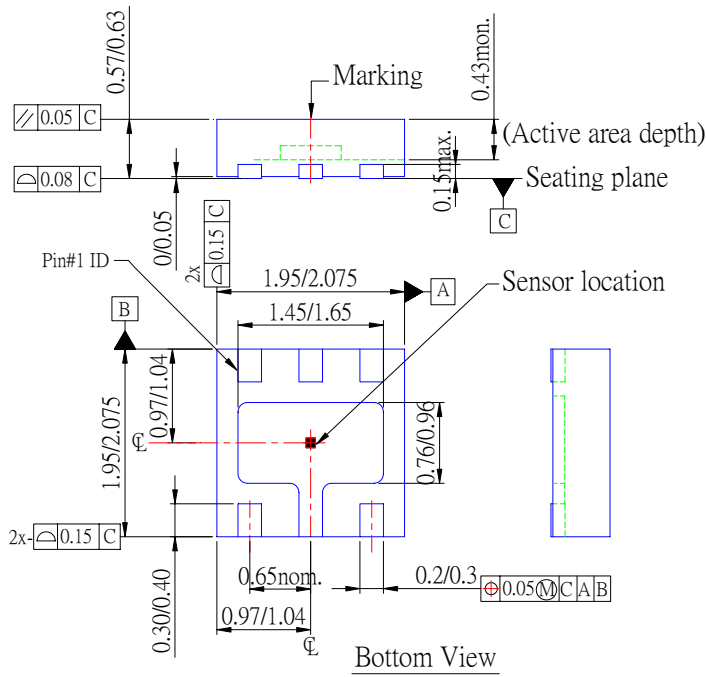

---

## Taping Orientation

---

For DFN2020-6

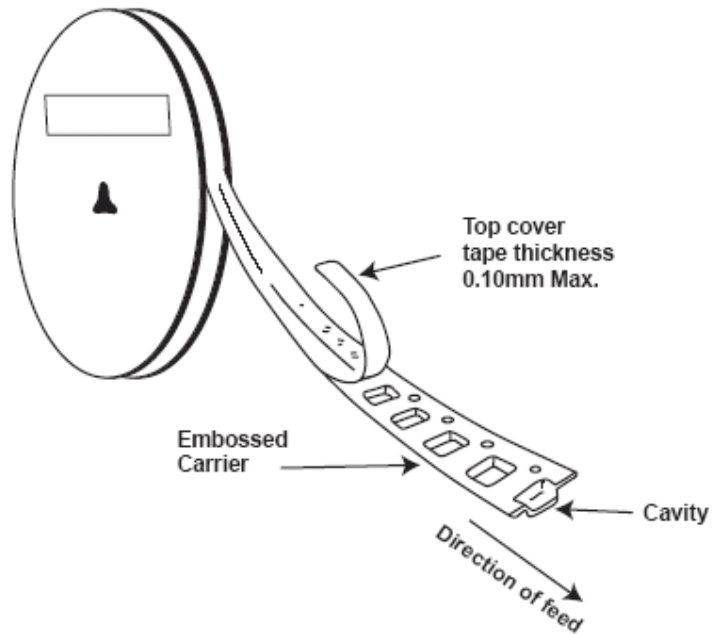
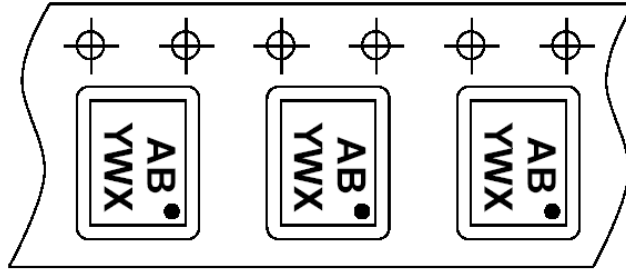

Notes: 8. The taping orientation of the other package type can be found on our website at <http://www.diodes.com/datasheets/ap02007.pdf>.



**IMPORTANT NOTICE**

DIODES INCORPORATED MAKES NO WARRANTY OF ANY KIND, EXPRESS OR IMPLIED, WITH REGARDS TO THIS DOCUMENT, INCLUDING, BUT NOT LIMITED TO, THE IMPLIED WARRANTIES OF MERCHANTABILITY AND FITNESS FOR A PARTICULAR PURPOSE (AND THEIR EQUIVALENTS UNDER THE LAWS OF ANY JURISDICTION).

Diodes Incorporated and its subsidiaries reserve the right to make modifications, enhancements, improvements, corrections or other changes without further notice to this document and any product described herein. Diodes Incorporated does not assume any liability arising out of the application or use of this document or any product described herein; neither does Diodes Incorporated convey any license under its patent or trademark rights, nor the rights of others. Any Customer or user of this document or products described herein in such applications shall assume all risks of such use and will agree to hold Diodes Incorporated and all the companies whose products are represented on Diodes Incorporated website, harmless against all damages.

Diodes Incorporated does not warrant or accept any liability whatsoever in respect of any products purchased through unauthorized sales channel.

Should Customers purchase or use Diodes Incorporated products for any unintended or unauthorized application, Customers shall indemnify and hold Diodes Incorporated and its representatives harmless against all claims, damages, expenses, and attorney fees arising out of, directly or indirectly, any claim of personal injury or death associated with such unintended or unauthorized application.

Products described herein may be covered by one or more United States, international or foreign patents pending. Product names and markings noted herein may also be covered by one or more United States, international or foreign trademarks.

**LIFE SUPPORT**

Diodes Incorporated products are specifically not authorized for use as critical components in life support devices or systems without the express written approval of the Chief Executive Officer of Diodes Incorporated. As used herein:

- A. Life support devices or systems are devices or systems which:
1. are intended to implant into the body, or
  2. support or sustain life and whose failure to perform when properly used in accordance with instructions for use provided in the labeling can be reasonably expected to result in significant injury to the user.
- B. A critical component is any component in a life support device or system whose failure to perform can be reasonably expected to cause the failure of the life support device or to affect its safety or effectiveness.

Customers represent that they have all necessary expertise in the safety and regulatory ramifications of their life support devices or systems, and acknowledge and agree that they are solely responsible for all legal, regulatory and safety-related requirements concerning their products and any use of Diodes Incorporated products in such safety-critical, life support devices or systems, notwithstanding any devices- or systems-related information or support that may be provided by Diodes Incorporated. Further, Customers must fully indemnify Diodes Incorporated and its representatives against any damages arising out of the use of Diodes Incorporated products in such safety-critical, life support devices or systems.

Copyright © 2009, Diodes Incorporated

[www.diodes.com](http://www.diodes.com)

# Mouser Electronics

Authorized Distributor

Click to View Pricing, Inventory, Delivery & Lifecycle Information:

[Diodes Inc.:](#)

[AH1803-SNG-7](#) [AH1803-WG-7](#)