

Description

The AH1802 is a ultra-sensitivity, micropower Omnipolar Hall Effect switch IC designed for portable and battery powered equipment such as cellular phones, PDA's and portable PC's. Based on two sensitive Hall Effect plates and a chopper stabilized architecture the AH1802 provides a reliable solution over the whole operating range. To support portable and battery powered equipment the design has been optimized to operate over the supply range of 2.5V to 5.5V and consumes only 24uW with a supply of 3V.

The single open drain output can switched on with either a north or south pole of sufficient strength. When the magnetic flux density (B) is larger than operate point (Bop) the output is switched on (pulled low). The output is turned off when B becomes lower than the release point (Brp). The output will remain off when there is no magnetic field.

Features

- Omni-polar (north or south pole) operation
- High sensitivity
- Single open drain output
- Micropower operation
- 2.5V to 5.5V operating range
- Chopper stabilized design provides
 - Superior temperature stability
 - Minimal switch point drift
 - Enhanced immunity to stress
- Good RF noise immunity
- -40°C to 85°C operating temperature
- ESD > 5kV for DFN2020-6, DFN2020-3 and DFN2015H4-3
ESD > 6kV for SC59
- Low profile SC59, DFN2020-6, DFN2020-3 and DFN2015H4-3 packages
- "Green" Molding Compound (Note 1)

Notes: 1. EU Directive 2002/95/EC (RoHS). All applicable RoHS exemptions applied. Please visit our website at http://www.diodes.com/products/lead_free.html.

Pin Assignments

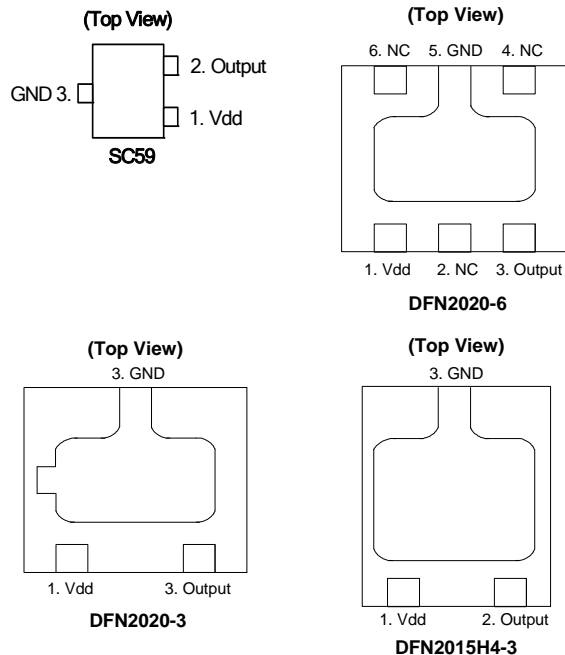

Applications

- Cover switch in clam-shell or slide type cellular phones
- Display switch for portable PCs
- On/Off switch for PDAs and digital cameras
- Contact-less switch in consumer products

Typical Application Circuit

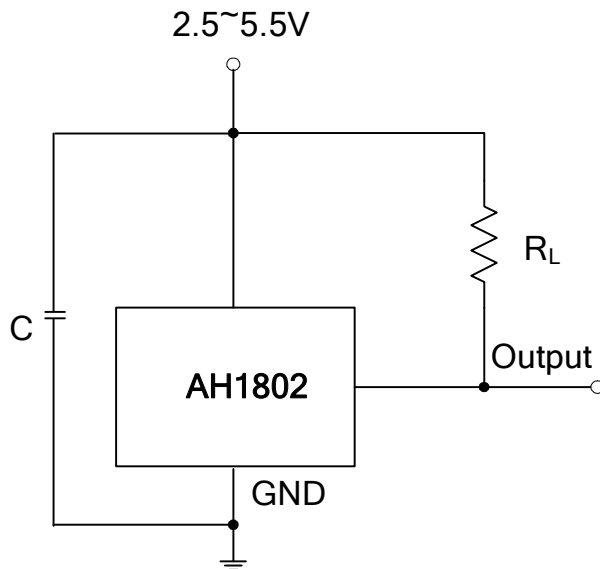

Pin Descriptions

Pin Name	P/I/O	Description
Vdd	P/I	Power Supply Input
GND	P/I	Ground
Output	O	Output Pin
NC		No connection (Note 2)

Notes: 2. NC is "No Connection"- recommendation is to connect the NC pin to ground externally.

Functional Block Diagram

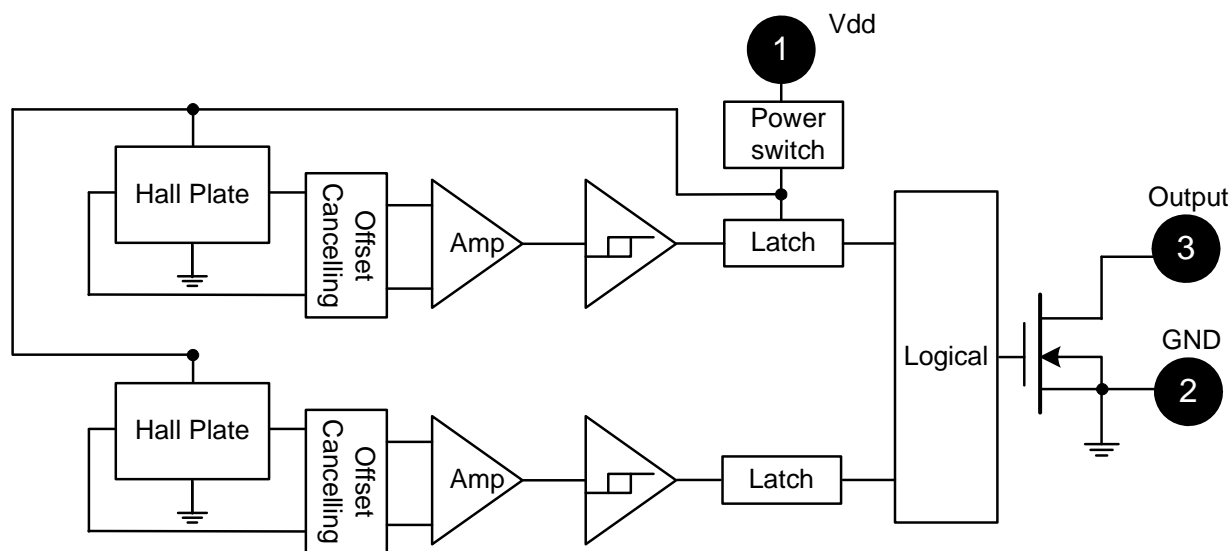

Absolute Maximum Ratings ($T_A = 25^\circ\text{C}$)

Symbol	Characteristics	Values	Unit
V _{dd}	Supply Voltage	7	V
B	Magnetic Flux Density	Unlimited	
T _s	Storage Temperature Range	-65 to +150	°C
P _D	Package Power Dissipation	230	mW
T _J	Maximum Junction Temperature	150	°C

Recommended Operating Conditions ($T_A = 25^\circ\text{C}$)

Symbol	Parameter	Conditions	Rating	Unit
V _{dd}	Supply Voltage	Operating	2.5 to 5.5	V
T _A	Operating Temperature Range	Operating	-40 to +85	°C

Electrical Characteristics ($T_A = 25^\circ\text{C}$, V_{dd} = 3V; unless otherwise specified)

Symbol	Characteristic	Conditions	Min	Typ.	Max	Unit
V _{out}	Output On Voltage	I _{out} =1mA	-	0.1	0.3	V
I _{off}	Output Leakage Current	V _{out} =5.5V, B < Brp	-	<0.1	1	μA
I _{dd(en)}	Supply Current	Chip enable, T _A = 25°C, V _{dd} = 3V	-	3	6	mA
		Chip enable, T _A = -40~85°C, V _{dd} = 2.5~5.5V	-	3	10	mA
I _{dd(dis)}		Chip disable, T _A = 25°C, V _{dd} = 3V	-	5	10	μA
		Chip disable, T _A = -40~85°C, V _{dd} = 2.5~5.5V	-	5	18	μA
I _{dd(avg)}		Average supply current , T _A = 25°C, V _{dd} = 3V	-	8	16	μA
		Average supply current , T _A = -40~85°C, V _{dd} = 2.5~5.5V	-	8	23	μA
F _c	Chopping Frequency	For design information only	-	300	-	KHz
T _{awake}	Awake Time	(Note 3)	-	75	150	μs
T _{period}	Period	(Note 3)	-	75	150	ms
D.C.	Duty Cycle		-	0.1	-	%

Notes: 3. When power is initially turned on, V_{dd} must be within its correct operating range (2.5V to 5.5V) to guaranteed the output sampling. The output state is valid after the second operating cycle (typical 150ms).

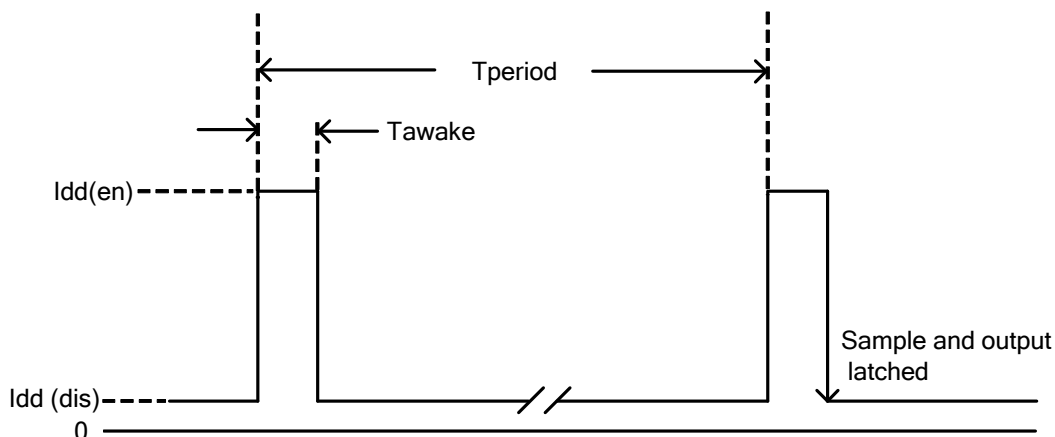

Magnetic Characteristics ($T_A = 25^\circ\text{C}$, $V_{dd} = 3\text{V}$, Note 4 & 5)

(1mT=10 Gauss)

Symbol	Characteristic	Min	Typ.	Max	Unit
Bops(south pole to brand side)	Operate Point	20	28	40	Gauss
Bopn(north pole to brand side)		-40	-28	-20	
Brps(south pole to brand side)	Release Point	10	20	-	
Brpn(north pole to brand side)		-	-20	-10	
$B_{hy}(B_{opx} - B_{rpx})$	Hysteresis	5	8	-	

Notes: 4. Typical data is at $T_A = 25^\circ\text{C}$, $V_{dd} = 3\text{V}$, and for design information only.
5. The magnetic characteristics may vary with supply voltage, operating temperature and after soldering.

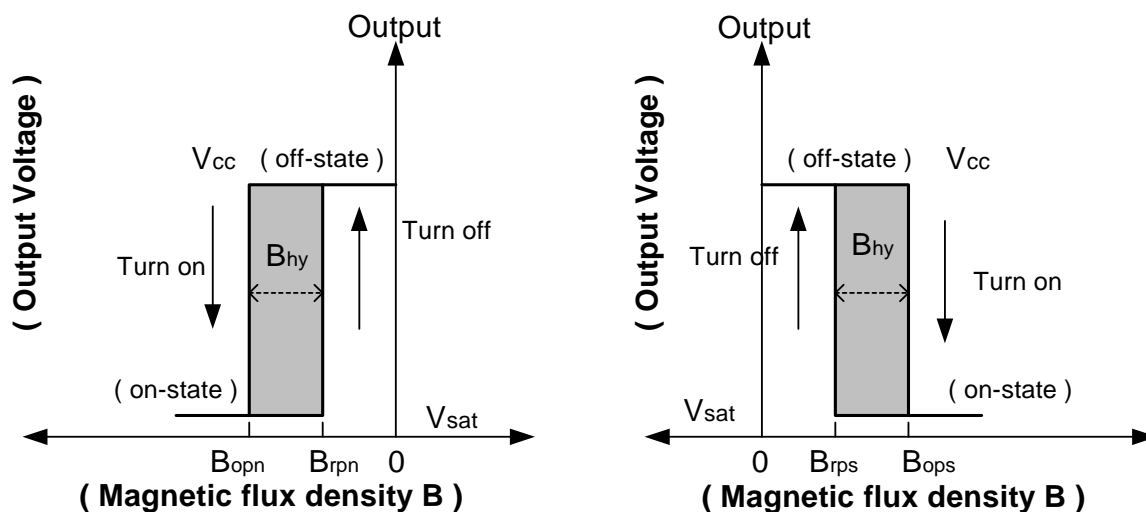

Performance Characteristics

T _A (°C)	25	50	60	70	80	85	90	100	110	120	130	140	150
P _D (mW)	230	184	166	147	129	120	110	92	74	55	37	18	0

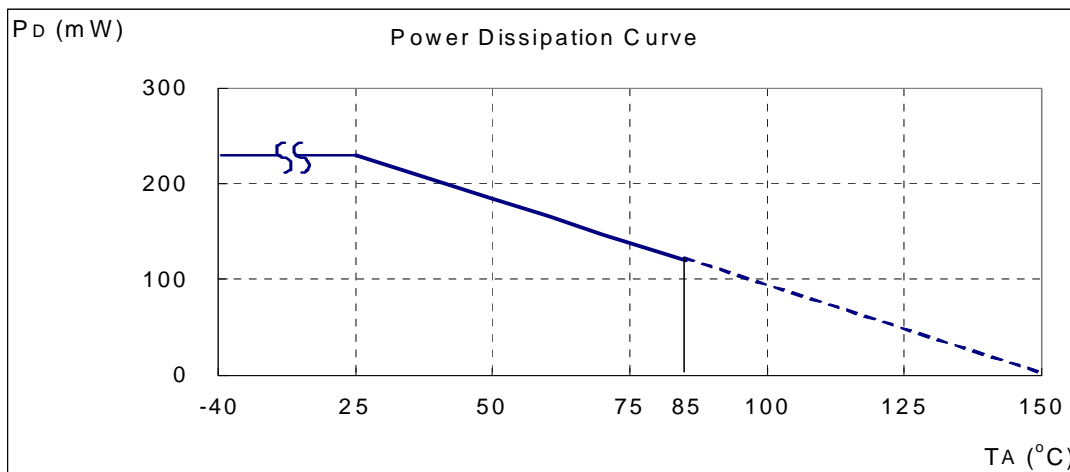

Ordering Information

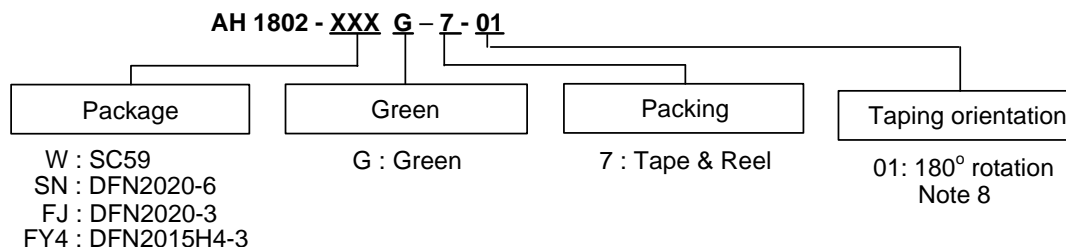

Device	Package Code	Packaging (Note 6 & 7)	7" Tape and Reel	
			Quantity	Part Number Suffix
AH1802-WG-7	W	SC59	3000/Tape & Reel	-7
AH1802-SNG-7	SN	DFN2020-6	3000/Tape & Reel	-7
AH1802-FJG-7	FJ	DFN2020-3	3000/Tape & Reel	-7
AH1802-FJG-7-01 (Note 8)	FJ	DFN2020-3	3000/Tape & Reel	-7
AH1802-FY4G-7	FY4	DFN2015H4-3	3000/Tape & Reel	-7

- Notes:
6. EU Directive 2002/95/EC (RoHS). All applicable RoHS exemptions applied. Please visit our website at http://www.diodes.com/products/lead_free.html.
 7. Pad layout as shown on Diodes Inc. suggested pad layout document AP02001, which can be found on our website at <http://www.diodes.com/datasheets/ap02001.pdf>.
 8. AH1802-FJG-7-01 DFN2020-3 package taping orientation is rotated by 180° compared to standard part AH1802-FJG-7. See package orientation diagrams on page 10.

Marking Information

(1) SC59

(Top View)

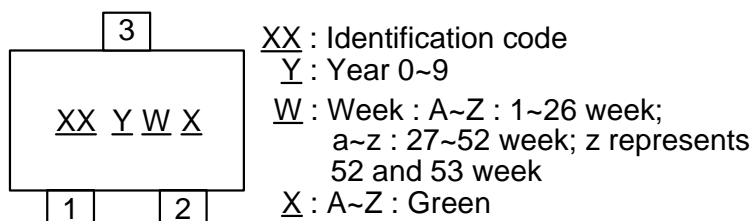

Part Number	Package	Identification Code
AH1802	SC59	KC

(2) DFN2020-6

(Top View)

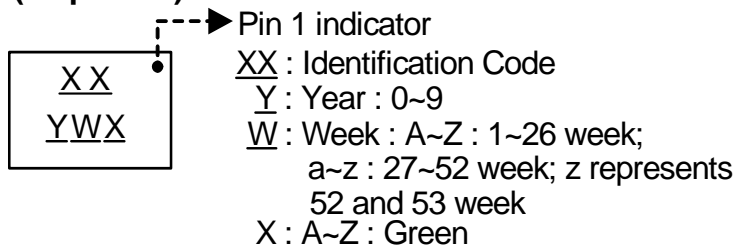

Part Number	Package	Identification Code
AH1802	DFN2020-6	KC

(3) DFN2020-3

(Top View)

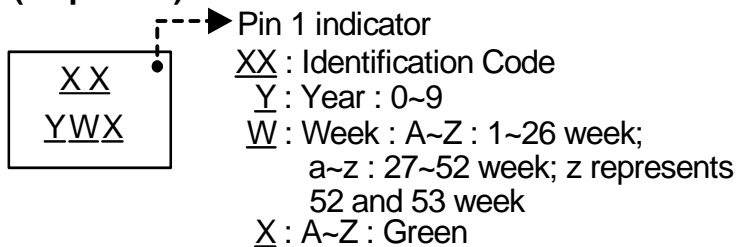

Part Number	Package	Identification Code
AH1802	DFN2020-3	KE

Marking Information (Continued)

(4) DFN2015H4-3

(Top View)

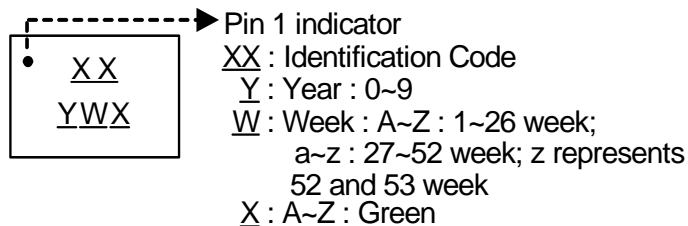

Part Number	Package	Identification Code
AH1802	DFN2015H4-3	KF

Package Outline Dimensions (All Dimensions in mm)

(1) Package Type: SC59

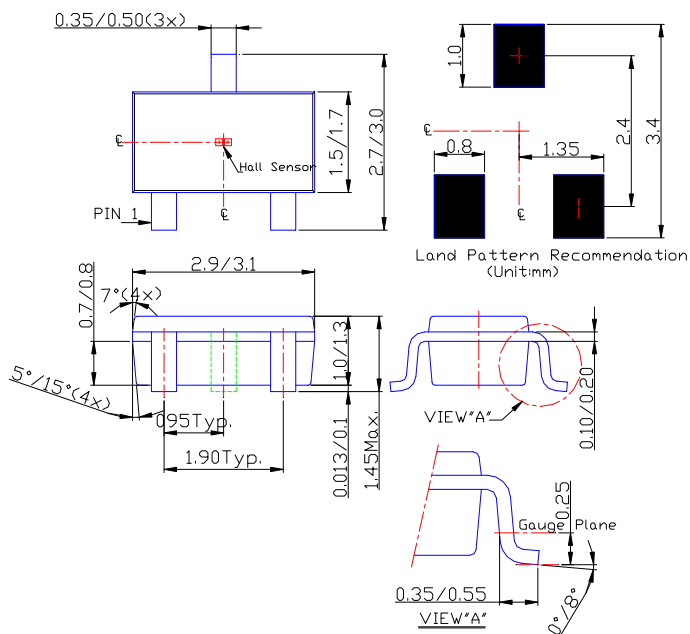

Package Outline Dimensions (Continued)

(4) Package type: DFN2015H4-3

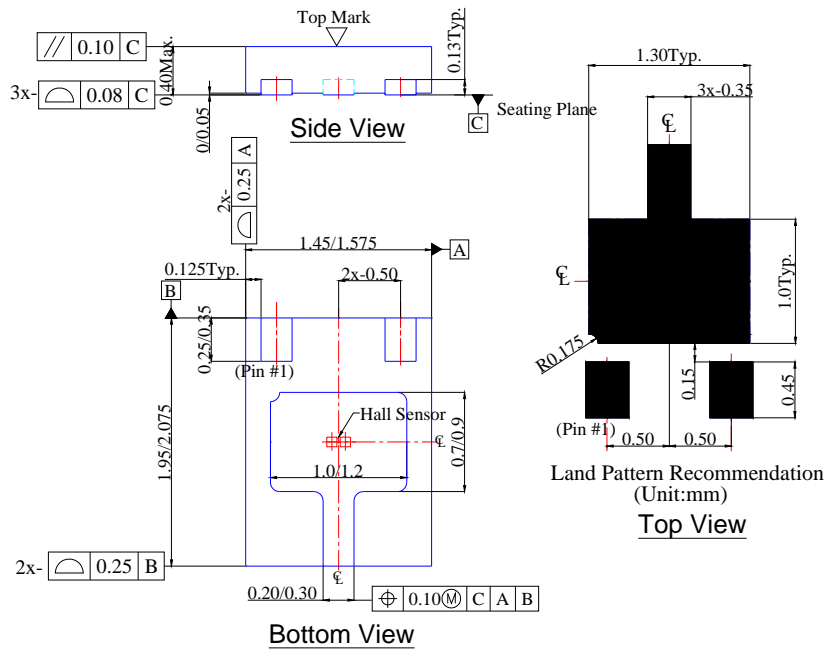

Taping Orientation

(1) DFN2020-6 and DFN2020-3 with standard taping orientation

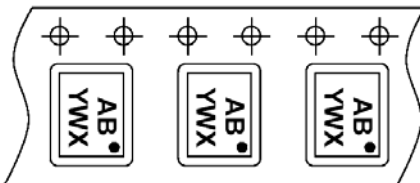

(2) DFN2020-3 with 180° rotation from standard taping orientation

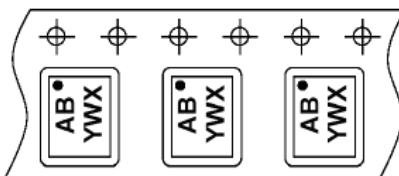

(3) DFN2015H4-3

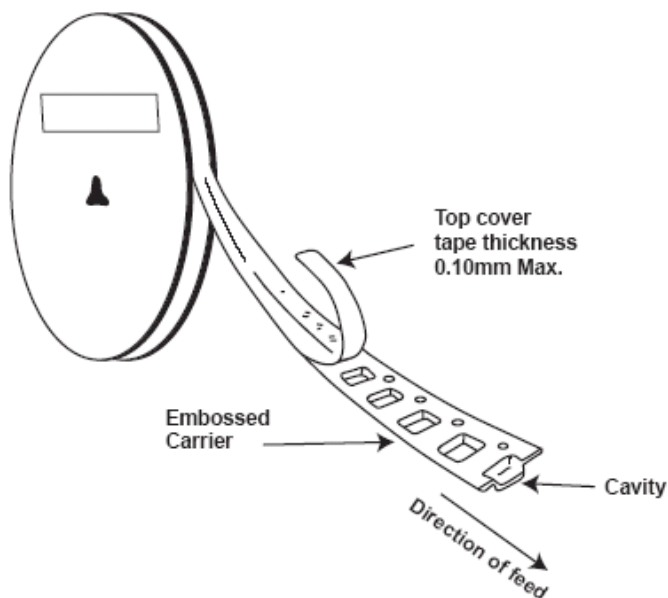
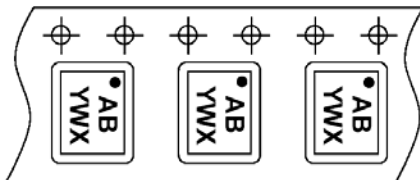

Notes: 9. The taping orientation of the other package type can be found on our website at <http://www.diodes.com/datasheets/ap02007.pdf>.

**MICROPOWER, ULTRA-SENSITIVE OMNIPOLAR
HALL-EFFECT SENSOR SWITCH****IMPORTANT NOTICE**

DIODES INCORPORATED MAKES NO WARRANTY OF ANY KIND, EXPRESS OR IMPLIED, WITH REGARDS TO THIS DOCUMENT, INCLUDING, BUT NOT LIMITED TO, THE IMPLIED WARRANTIES OF MERCHANTABILITY AND FITNESS FOR A PARTICULAR PURPOSE (AND THEIR EQUIVALENTS UNDER THE LAWS OF ANY JURISDICTION).

Diodes Incorporated and its subsidiaries reserve the right to make modifications, enhancements, improvements, corrections or other changes without further notice to this document and any product described herein. Diodes Incorporated does not assume any liability arising out of the application or use of this document or any product described herein; neither does Diodes Incorporated convey any license under its patent or trademark rights, nor the rights of others. Any Customer or user of this document or products described herein in such applications shall assume all risks of such use and will agree to hold Diodes Incorporated and all the companies whose products are represented on Diodes Incorporated website, harmless against all damages.

Diodes Incorporated does not warrant or accept any liability whatsoever in respect of any products purchased through unauthorized sales channel.

Should Customers purchase or use Diodes Incorporated products for any unintended or unauthorized application, Customers shall indemnify and hold Diodes Incorporated and its representatives harmless against all claims, damages, expenses, and attorney fees arising out of, directly or indirectly, any claim of personal injury or death associated with such unintended or unauthorized application.

Products described herein may be covered by one or more United States, international or foreign patents pending. Product names and markings noted herein may also be covered by one or more United States, international or foreign trademarks.

LIFE SUPPORT

Diodes Incorporated products are specifically not authorized for use as critical components in life support devices or systems without the express written approval of the Chief Executive Officer of Diodes Incorporated. As used herein:

- A. Life support devices or systems are devices or systems which:
1. are intended to implant into the body, or
 2. support or sustain life and whose failure to perform when properly used in accordance with instructions for use provided in the labeling can be reasonably expected to result in significant injury to the user.
- B. A critical component is any component in a life support device or system whose failure to perform can be reasonably expected to cause the failure of the life support device or to affect its safety or effectiveness.

Customers represent that they have all necessary expertise in the safety and regulatory ramifications of their life support devices or systems, and acknowledge and agree that they are solely responsible for all legal, regulatory and safety-related requirements concerning their products and any use of Diodes Incorporated products in such safety-critical, life support devices or systems, notwithstanding any devices- or systems-related information or support that may be provided by Diodes Incorporated. Further, Customers must fully indemnify Diodes Incorporated and its representatives against any damages arising out of the use of Diodes Incorporated products in such safety-critical, life support devices or systems.

Copyright © 2010, Diodes Incorporated

www.diodes.com

Mouser Electronics

Authorized Distributor

Click to View Pricing, Inventory, Delivery & Lifecycle Information:

[Diodes Inc.:](#)

[AH1802-FJG-7](#) [AH1802-FY4G-7](#) [AH1802-SNG-7](#) [AH1802-WG-7](#)