

# Preliminary Specification

## Allegro Current Sensor: ACS750

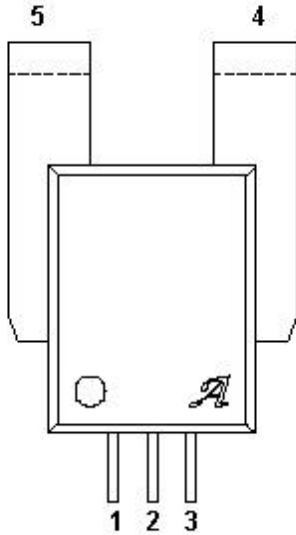

Pin 1: Vcc  
Pin 2: Gnd  
Pin 3: Output  
Pin 4: Ip+  
Pin 5: Ip-

### ABSOLUTE MAXIMUM RATINGS

Over-Current .....	225 A <sup>1</sup>
Supply Voltage, Vcc.....	16V
Output Voltage .....	16V
Output Current Source.....	3mA
Output Current Sink .....	10mA
Operating Temperature .....	-40°C to 150°C
Storage Temperature.....	170°C
Maximum junction temperature.....	165°C

The Allegro Current Sensor provides an economical and precise solution for current sensing in automotive and industrial systems, packaged for easy implementation. Typical applications include motor control, load management, switched mode power supplies and over-current fault protection.

The sensor consists of a precision linear Hall IC optimized to an internal magnetic circuit to increase device sensitivity. A combination of a precisely controlled self-aligning assembly process (patents pending) and the factory programmed precision of the linear Hall sensor result in high level performance and product uniformity.

The power lead frame used for current sensing (pins 4 and 5) is designed for extremely low power loss. The power leads are also electrically isolated from the sensor leads (pins 1 – 3). This isolation allows the Allegro Current Sensor to be used in applications requiring electrical isolation without the use of opto-isolators or other isolating feedback techniques.

An electrical current flowing from pins 4 to 5 will generate an analog voltage  $>V_{cc}/2$  on the output.

### Features and Benefits

- Monolithic Hall IC for High Reliability
- ACS750LCA-075: +/- 75A up to 150°C
- ACS750ECA-100: +/- 100A up to 85°C
- Ultra-low Power Loss: Resistance = 120uΩ
- No Trimming Required in the Application
- Factory Trimmed for Gain and Offset
- Linearity > 98.5%
- Very Low Thermal Drift of Offset Voltage
- 13kHz Bandwidth
- Single supply +5V Operation
- Ratiometric Output from Supply Voltage
- On-chip transient protection

### Applications

- Automotive Systems
- Industrial Systems
- Motor Control
- Servo Systems
- Power Conversion
- Battery Monitor

<sup>1</sup> 1 sec pulse, 10% duty cycle

# Preliminary Specification

## Allegro Current Sensor: ACS750LCA

### Operating Characteristics

Characteristic	Symbol	Test Conditions	Limits			Units
			Min.	Typ.	Max.	
<b>ELECTRICAL CHARACTERISTICS</b>						
Primary Sensed Current	$I_P$	-40°C to 150°C	-75		75	A
		-40°C to 85°C	-100		100	
Supply Voltage	$V_{CC}$		4.5	5.0	5.5	V
Supply Current	$I_{CC}$	$V_{CC} = 5.0V$ , Output open		7	10	mA
Output Resistance	$R_{out}$	$I_{out} = 1.2$ mA		1	2	$\Omega$
Isolation Voltage <sup>2</sup>	$V_{ISO}$	Between pins 1-3 and 4-5		2.5		kV
Propagation time	$t_{propagation}$	$I_P = \pm 50A$ ; $T = +25^\circ C$		4		$\mu s$
Response time	$t_{response}$	$I_P = \pm 50A$ ; $T = +25^\circ C$		27		$\mu s$
Rise time	$t_{rise\ time}$	$I_P = \pm 50A$ ; $T = +25^\circ C$		26		$\mu s$
Frequency Bandwidth	$f$	-3dB		13		kHz
<b>PERFORMANCE CHARACTERISTICS (Over -40°C to 150°C temperature range unless otherwise specified)</b>						
Sensitivity	Sens	$I_P = \pm 75A$ ; $T = +25^\circ C$	18.75	19.75	20.75	mV/A
		$I_P = \pm 100A$ ; $T = +25^\circ C$	18.5	19.5	20.5	
Noise <sup>3</sup>		Peak to peak; $T = +25^\circ C$ BW = 40kHz		10		mV
Non-linearity		$I_P = \pm 75A$ , $T = -40^\circ C$ to $150^\circ C$		1.3	3.5	%
		$I_P = \pm 100A$ , $T = -40^\circ C$ to $85^\circ C$		2.4	5	%
Symmetry	Sym	$I_P = \pm 75A$ , $T = -40^\circ C$ to $150^\circ C$	94	100	106	%
		$I_P = \pm 100A$ , $T = -40^\circ C$ to $85^\circ C$	94	100	106	%
Quiescent Output Voltage <sup>4</sup>	$V_{OQ}$	$I_P = 0$ A; $T = +25^\circ C$	-20	$V_{CC}/2$	+20	mV
Thermal Drift of $V_{OQ}$ <sup>5</sup>	$\Delta V_{OQ}(T)$	$I_P = 0$ A	-0.5	-0.12	+0.3	mV/°C
Thermal Drift of Sens	$\Delta Sens(T)$	$I_P = \pm 75A$ ; $T = -40^\circ C$ to $150^\circ C$	-8	0	+7	%
		$I_P = \pm 100A$ ; $T = -40^\circ C$ to $85^\circ C$	-9	0	+6	
Magnetic Core Hysteresis <sup>6</sup>	$V_{OH}$	After excursion to +/-100A $T = +25^\circ C$		+/-0.3	+/-0.4	A
0 Amp Accuracy Including offset	0 A	$T = +25^\circ C$		+/-0.4	+/-1.8	A
		$T = -40^\circ C$ to $85^\circ C$		+/-0.75	+/-2.7	A
		$T = -40^\circ C$ to $150^\circ C$		+/-1.1	+/-3.2	A
Total Accuracy <sup>7</sup>	Full Scale	$I_P = \pm 75A$ ; $T = +25^\circ C$		+/-1.0	+/-2.5	%
		$I_P = \pm 100A$ ; $T = +25^\circ C$		+/-2.0	+/-4.0	%
		$I_P = \pm 75A$ ; $T = -40^\circ C$ to $150^\circ C$		+/-2.4	+/-8.2	%
		$I_P = \pm 100A$ ; $T = -40^\circ C$ to $85^\circ C$		+/-4.9	+/-12.6	%

<sup>2</sup> R.M.S. voltage for AC isolation test, 60 Hz, 5 min. duration.

<sup>3</sup> Refer to figure 5 for schematic of test circuit

<sup>4</sup> Omitting magnetic hysteresis offset

<sup>5</sup> Qvo & Sensitivity gain drift referenced to 25°C

<sup>6</sup> Refer to figure 6 for hysteresis temperature characterization

<sup>7</sup> Please contact Allegro sales representative for competitive comparison

# Preliminary Specification

## Allegro Current Sensor: ACS750LCA

### Definitions of accuracy characteristics

**Sensitivity:** The sensitivity is the change in sensor output to 1A change through the primary conductor. The sensitivity is the product of the magnetic circuit sensitivity (G/A) and the linear IC amplifier gain (mV/G). The linear IC amplifier gain is trimmed to optimize the sensitivity (mV/A) for the full-scale current of the device. Variation in the sensitivity is affected by the resolution of the Allegro linear IC sensitivity trim (~10uV/step) and thermal drift (expressed in %/C).

**Noise:** The noise is the product of the linear IC amplifier gain (mV/G) and the noise floor for the Allegro linear IC (~1Gauss). The noise floor is derived from the thermal and shot noise observed in Hall elements. Dividing the noise (mV) by the sensitivity (mV/A) provides the smallest current that the device is able to resolve.

**Linearity:** The linearity is the degree to which the voltage output from the sensor varies in direct proportion to the primary current through its full-scale amplitude. Linearity reveals the maximum deviation from the ideal transfer curve for this transducer. Non-linearity in the output can be attributed to the gain variation across temperature and saturation of the flux concentrator approaching the full scale current. The following equation is used to derive the linearity:

$$[1 - \frac{V_{out\_full-scale\ Amps} - V_{out\_0A}}{2 * (V_{out\_1/2\ full-scale\ Amps} - V_{out\_0A})}] * 100$$

**Symmetry:** Symmetry is the degree to which the absolute voltage output from the sensor varies in proportion to either a positive or negative full-scale primary current. The following equation is used to derive symmetry:

$$\frac{V_{out\_full-scale\ Amps} - V_{out\_0A}}{V_{out\_0A} - V_{out\_full-scale\ Amps}} * 100$$

**Quiescent output voltage:** The quiescent output voltage ( $V_{OQ}$ ) is the output of the sensor when the primary current is zero. For a unipolar supply voltage,  $V_{OQ}$  nominally sits at  $V_{cc}/2$ .  $V_{cc} = 5V$  translates into  $V_{OQ} = 2.5V$ . Variation in  $V_{OQ}$  can be attributed to the resolution of the Allegro linear IC quiescent voltage trim (~2.5mV), magnetic hysteresis, and thermal drift (expressed in %/C).

**Magnetic hysteresis (offset):** The magnetic offset is due to the residual magnetism (remanent field) that induces an offset in gauss. The magnetic offset error is highest when the magnetic circuit has been saturated, usually when the device has been subjected to a full scale or high current overload conditions. The magnetic offset is largely dependent on the material used as a flux concentrator. For most materials, the largest magnetic offset is observed at the lowest operating temperature.

**Accuracy:** The accuracy represents the maximum deviation of the actual output from its ideal value. This is also known as the total error. The accuracy is illustrated graphically in Figure #1. The accuracy is divided into four areas of particular interest defined below:

- **0 A @ 25°C:** Accuracy of sensing zero current flow at 25°C, without the effects of temperature.
- **0 A over temperature:** Accuracy of sensing zero current flow including temperature effects.
- **Full-scale current @ 25°C:** Accuracy of sensing the full-scale current at 25°C, without the effects of temperature.
- **Full-scale current over temperature:** Accuracy of sensing full-scale current flow including temperature effects.

# Preliminary Specification

## Allegro Current Sensor: ACS750LCA

**Figure 1: Output Voltage vs. Current, illustrating sensor accuracy at 0A and full-scale current**

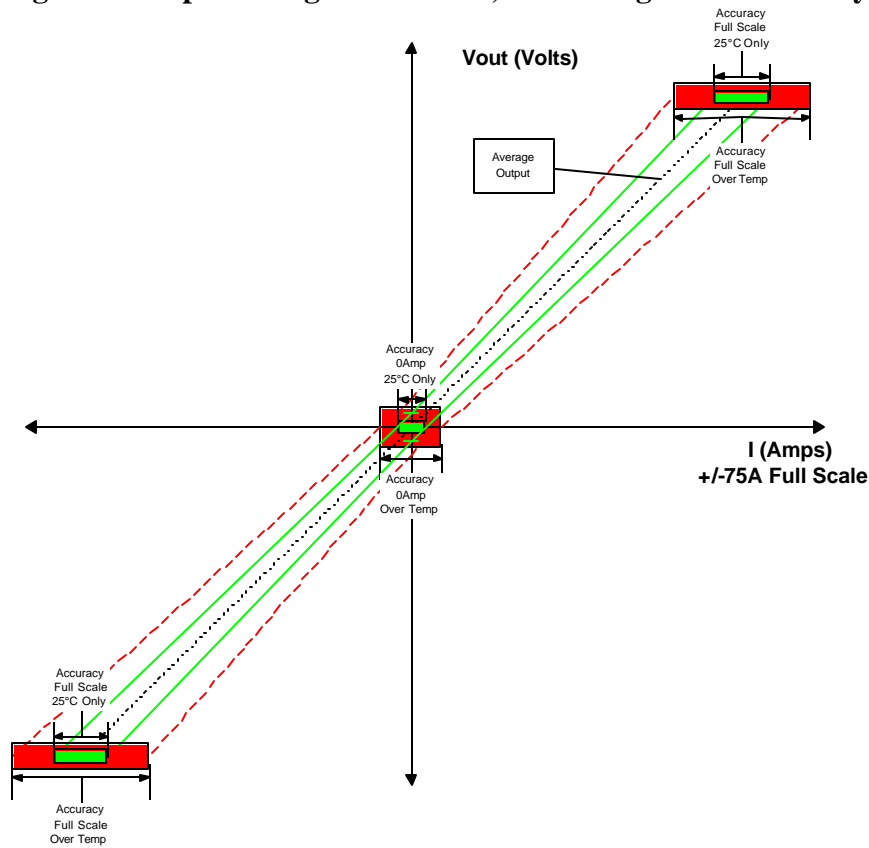

**Figure 2: Block diagram of ACS750LCA-075 and linear Hall Effect IC functionality**

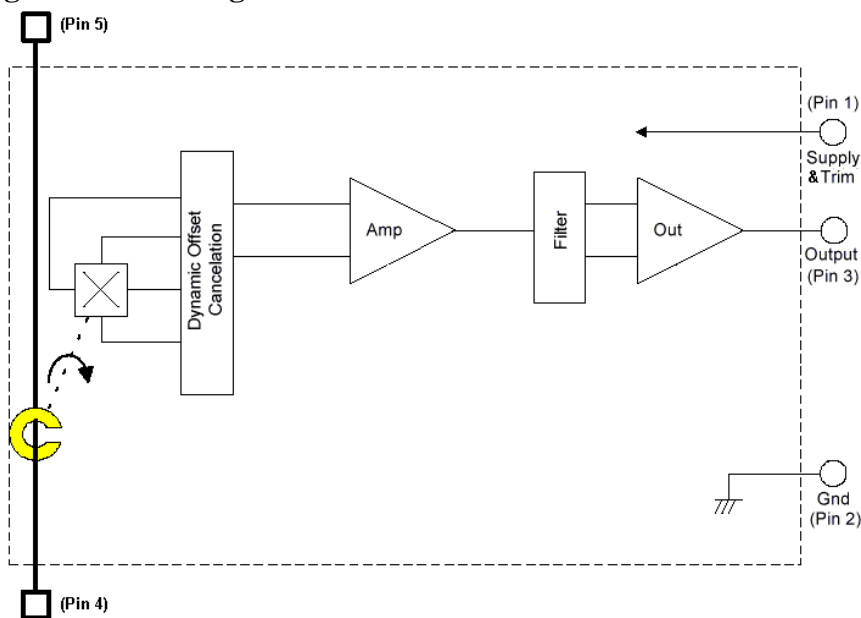

# Preliminary Specification

## Allegro Current Sensor: ACS750LCA

Figure 3: Primary current versus typical output voltage across temperature

$I_{\text{primary}}$  vs  $V_{\text{out}}$ , ACS750LCA-075

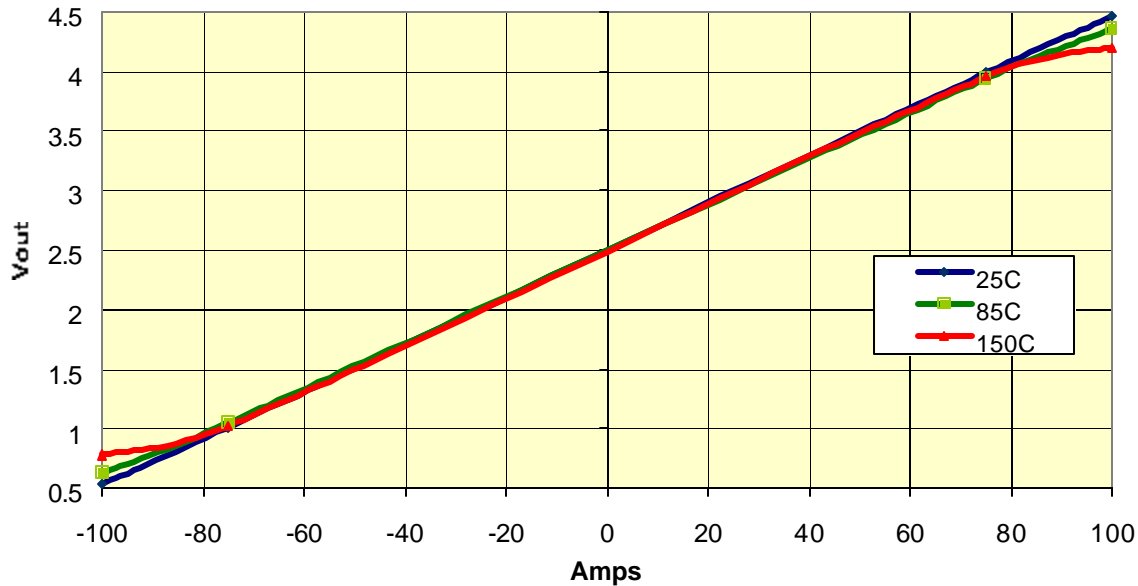
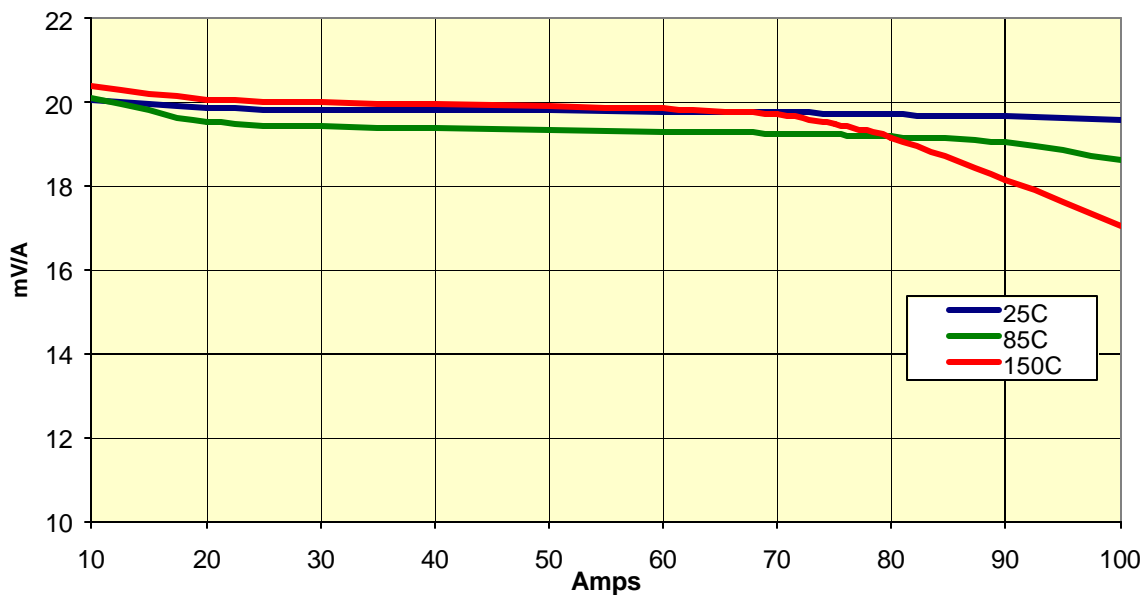

Figure 4: Primary current versus typical sensitivity across temperature

$I_{\text{primary}}$  vs Sensitivity, ACS750LCA-075



# Preliminary Specification

## Allegro Current Sensor: ACS750LCA

Figure 5a – Test circuit used to determine peak to peak & RMS noise in linear IC output

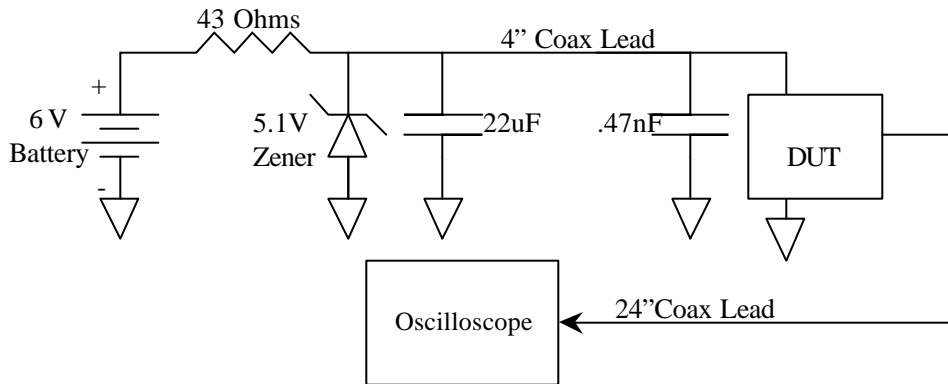

Figure 5b. Noise Analysis of Linear Hall Effect IC within ACS750LCA-075 Package

Peak to Peak Noise

Frequency Spectrum of Noise

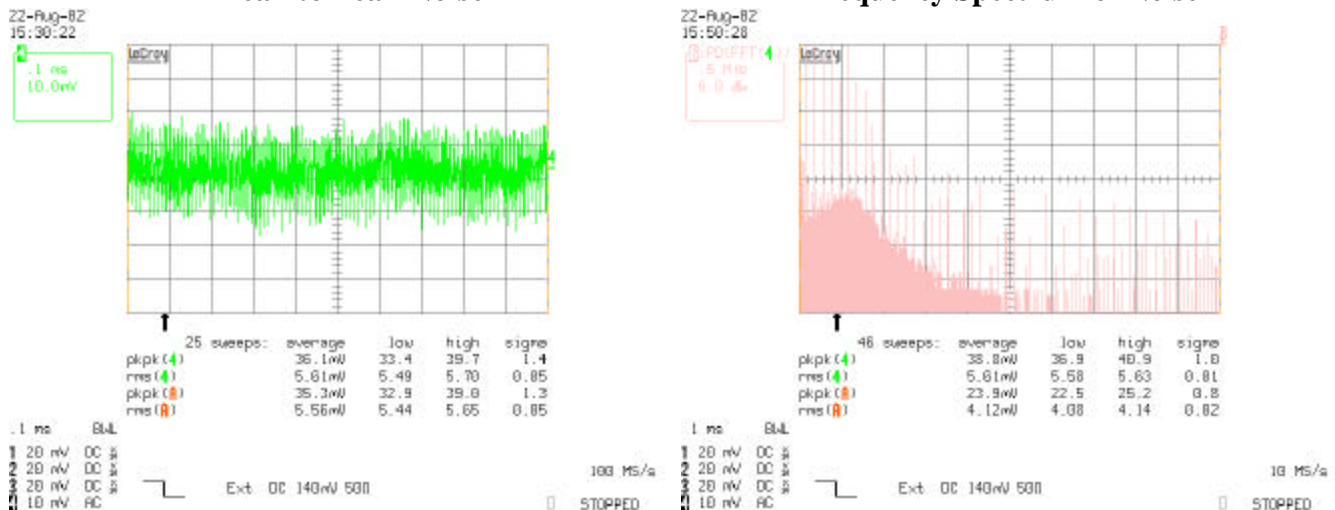

Figure 5c: Peak to Peak Noise, Applying Low Pass Filter to the ACS750LCA-075 Output

Low Pass Filter Break Frequency	Peak to Peak Noise
1.4MHz	34mV
400kHz	26mV
160kHz	19mV
80kHz	14mV
40kHz	10mV

# Preliminary Specification

## Allegro Current Sensor: ACS750LCA

Figure 6: Peak to Peak Hysteresis Across Temperature (after excursion to +/-150A)

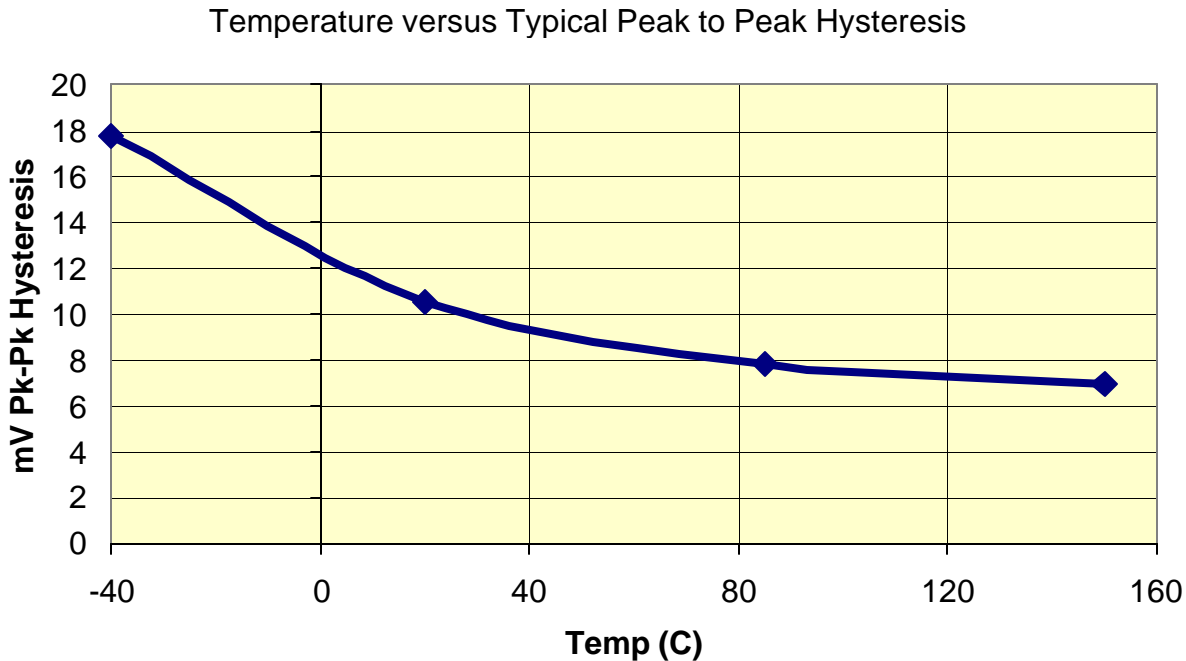
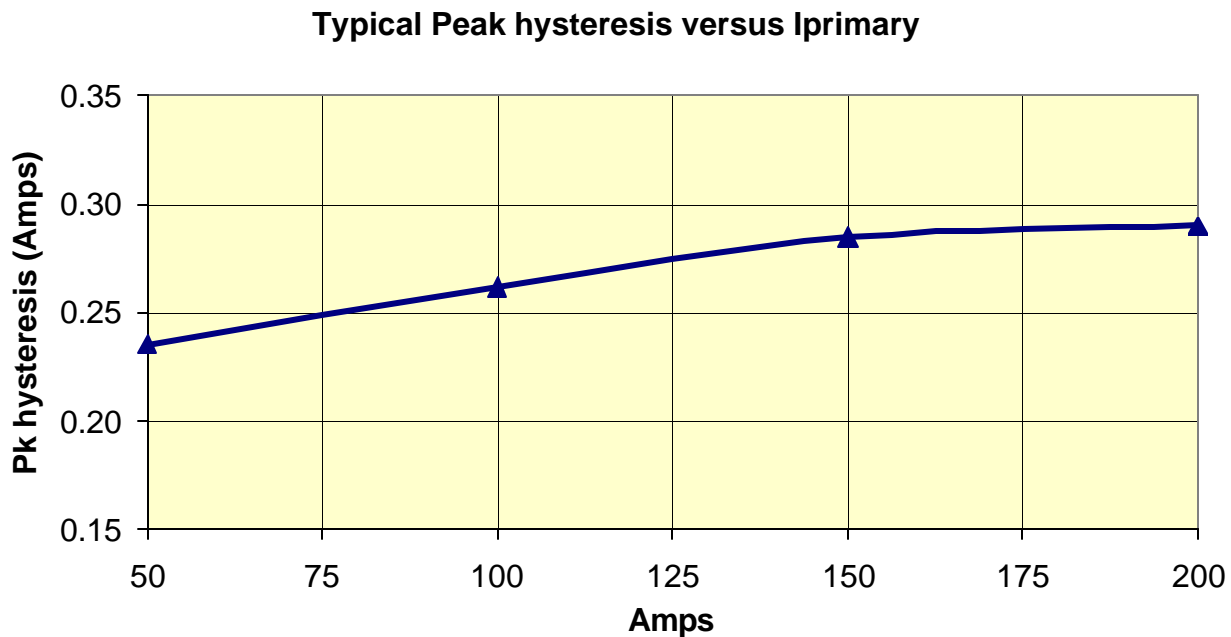

Figure 7: Peak Hysteresis versus Iprimary, 25C



# Preliminary Specification

## Allegro Current Sensor: ACS750LCA

**Figure 8: Rejection of Transient Voltage Signal on Iprimary, Typical Attenuation ~55dB**

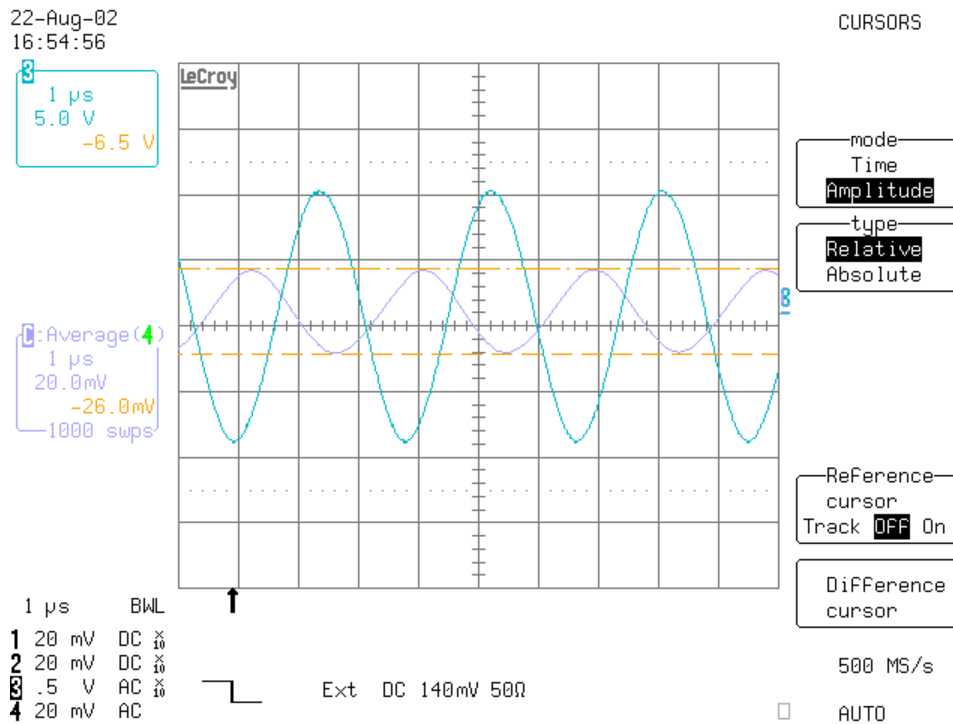

**Figure 9: Step response of ACS750LCA-075, Iprimary = 50A**

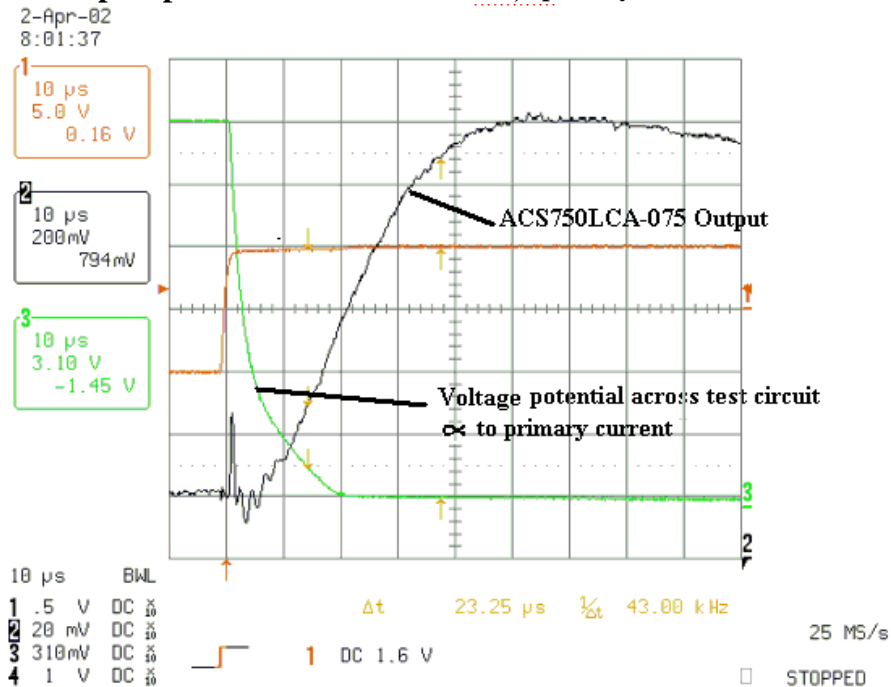



# Preliminary Specification

## Allegro Current Sensor: ACS750LCA

### Definitions of dynamic response characteristics

**Propagation delay:** Propagation delay is the time that it takes for the sensor output to reflect a change in the primary current signal. Propagation delay is typically measured to be 3 to 5usec and is attributed to inductive loading within the linear IC package as well as the inductive loop formed by the primary conductor geometry. Propagation delay can be considered as a fixed time offset and may be compensated.

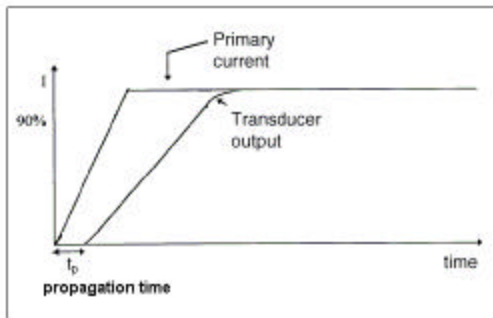

**Response time:** Response time is the time between when the primary current signal reaches 90% of its final value and when the sensor reaches 90% of its output corresponding to the applied current.

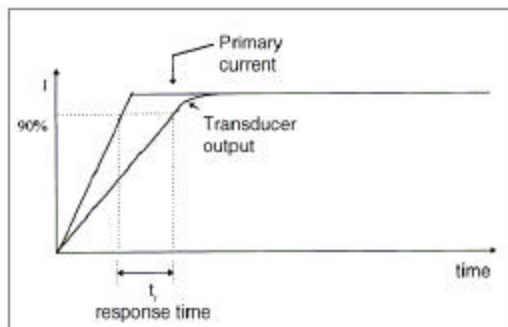

**Rise time:** Rise time is the time between the sensor output reaching 10 and 90% of its full scale value. The rise time to a step response is used to derive the bandwidth of the current sensor, in which  $f(-3dB) = 0.35/t_r$ . Both rise time and response time are detrimentally affected by eddy current losses observed in the conductive IC ground plane and to varying degrees, in the ferrous flux concentrator within the current sensor package.

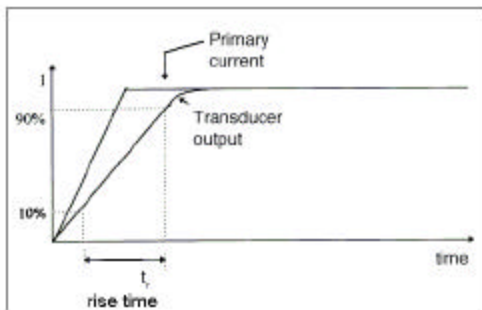

# Preliminary Specification

## Allegro Current Sensor: ACS750LCA

### Package thermal performance

	Symbol	Test Conditions	Limits		
			Typical	Max.	Units
Electrical resistance of primary conductor	$R_{primary}$	$I_p = \pm 100A; +25^{\circ}C$	130	TBD	$\mu\Omega$
Full-scale power dissipation	$P_{primary}$	$I_p = \pm 100A; +25^{\circ}C$	1.5	TBD	W
Thermal resistance, Junction to Air	$\theta_{JA}$	$T_{ambient} = +25^{\circ}C$	9	TBD	$^{\circ}C/W$

**Figure 10: Thermal performance of current sensor, continuous current through primary conductor<sup>8</sup>**

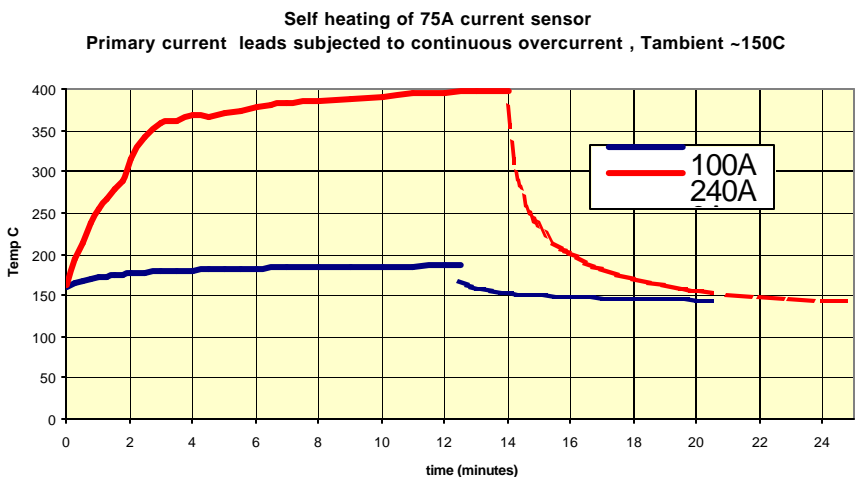
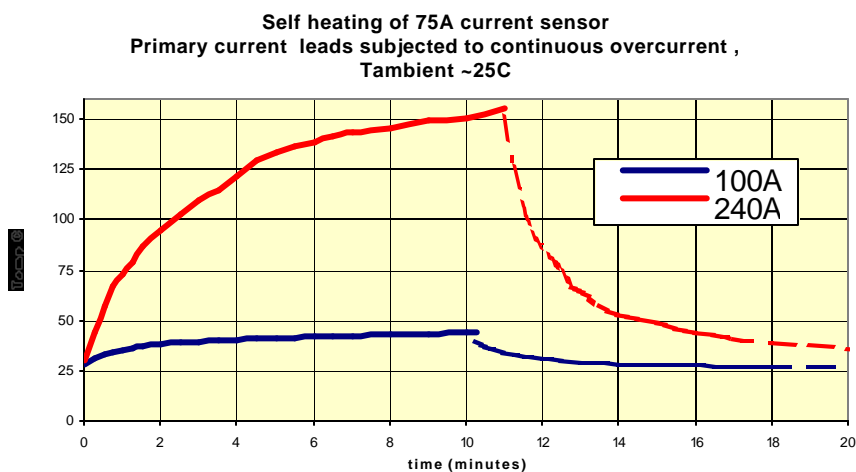

<sup>8</sup> Over current peak operation is 225A peak, 1 second duration with 10% duty cycle

# Preliminary Specification

## Allegro Current Sensor: ACS750LCA

### PACKAGE DRAWING

REVISIONS				
REV.	REV.	DESCRIPTION	DATE	APPROVED

**Notes:**

1. This drawing is only a preliminary issue and no tolerances are implied to any dimension.
2. Draft angle is 10° unless otherwise specified.
3. All edges can have up to 0.25mm radius unless otherwise specified.
4. There is reduced solder joint reliability at bends or where copper is exposed due to trimming or forming of leads.
5. Since leadframes are pre-plated, there is no solder coverage where leadframe is separated or at lead terminations.
6. There may be lead flash along edge or sides for 3mm from package.
7. Tooling marks on the leadframes are normal due to the close molding tolerances needed to prevent excessive flash.
8. Final drawing will be issued once sufficient data has been collected.

162 Pembroke Road  
 Concord, NH 03301  
 (603) 228-5533

<b>UNLESS OTHERWISE SPECIFIED USE THE FOLLOWING</b>	<b>DESIGNER</b>	<b>DATE</b>	<b>TITLE</b>								
	OWEN	9-27-02	100 Amp Current Sensor Preliminary Customer Drawing								
<b>INTERPRET DIMS PER ANSI Y14.2M-1992</b>	<b>CHECKED</b>										
	<b>APPROVED</b>										
<b>TOLERANCES</b>	<b>ALL DIMENSIONS IN MILLIMETERS</b>		<b>REV.</b>								
<table style="font-size: x-small; border-collapse: collapse;"> <tr><td>∅</td><td>± 0.5</td></tr> <tr><td>∅</td><td>± 0.2</td></tr> <tr><td>∅</td><td>± 0.1</td></tr> <tr><td>P</td><td></td></tr> </table>	∅	± 0.5	∅	± 0.2	∅	± 0.1	P		PROPERTY OF ALLEGRO MICROSYSTEMS, INC. USE AND/OR REPRODUCTION ONLY AS EXPRESSLY AUTHORIZED. TO BE RETURNED UPON DEMAND.		<b>REV. A</b>
∅	± 0.5										
∅	± 0.2										
∅	± 0.1										
P											
	<b>SCALE</b>	<b>100%</b>	<b>SHEET 1 OF 1</b>								

# Preliminary Specification

# Allegro Current Sensor: ACS750LCA

**This page is intentionally left blank.**