

Power Bridge Rectifiers

**SKB 25
SKD 25**

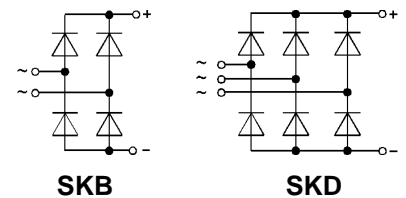

Features

- Square plastic case with isolated metal base plate and fast-on connectors
- Blocking voltage to 1600 V
- High surge currents
- **SKB** = single phase bridge rectifier
- **SKD** = three phase bridge rectifier
- Easy chassis mounting
- UL recognized, file no. E 63 532

Typical Applications

- Single and three phase rectifiers for power supplies
- Input rectifiers for variable frequency drives
- Rectifiers for DC motor field supplies
- Battery charger rectifiers

V _{RSM} V _{RRM}	I _D (T _{case} = ...)			
	17 A = (75 °C)		20 A (73 °C)	
V	Types	R _{min} Ω	Types	R _{min} Ω
100	SKB 25/01	0,1	–	–
200	SKB 25/02	0,15	SKD 25/02	0,15
400	SKB 25/04	0,3	SKD 25/04	0,3
600	SKB 25/06	0,5	–	–
800	SKB 25/08	0,7	SKD 25/08	0,7
1200	SKB 25/12	1	SKD 25/12	1
1400	SKB 25/14	1,2	SKD 25/14	1,2
1600	SKB 25/16	1,5	SKD 25/16	1,5

Symbol	Conditions	SKB 25	SKD 25	Units
I _D	T _{amb} = 45 °C; isolated ¹⁾ chassis ²⁾ R4A/120 P1A/120	3,5 10 14 17	3,5 12 15 20	A A A A
I _{DCL}	T _{amb} = 45 °C; isolated ¹⁾ chassis ²⁾ R4A/120 P1A/120	3 9,5 12 14	3,5 12 15 20	A A A A
I _{FSM}	T _{vj} = 25 °C, 10 ms T _{vj} = 150 °C, 10 ms	370 320		A A
i ² t	T _{vj} = 25 °C, 8,3...10 ms T _{vj} = 150 °C, 8,3...10 ms	680 500		A ² s A ² s
V _F	T _{vj} = 25 °C; I _F = 150 A	2,2		V
V _(TO)	T _{vj} = 150 °C	0,85		V
r _T	T _{vj} = 150 °C	12		mΩ
I _{RD}	T _{vj} = 25 °C; V _{RD} = V _{RRM} T _{vj} = 150 °C; V _{RD} = V _{RRM}	0,3 5		mA mA
t _{rr} f _G	T _{vj} = 25 °C	typ. 10 2000		μs Hz
R _{thjc} R _{thch} R _{thja}	total total isolated ¹⁾ chassis ²⁾ R4A/120 P1A/120	2 0,15 15 4,7 3,6 2,75	1,75	°C/W °C/W °C/W °C/W °C/W °C/W
T _{vj} T _{stg}		– 40...+ 150 – 55...+ 150		°C °C
V _{isol} RC	a.c. 50...60 Hz; r.m.s.; 1 s/ 1 min P _R = 1 W	3000 / 2500 50 0,1		V~ Ω μF
Fu M ₁	to heatsink SI units US units	20 2 ± 15 % 18 ± 15 %		A Nm lb. in.
w		24	26	g
Case		G 10	G 11	

1) Freely suspended or mounted on an insulator

2) Mounted on a painted metal sheet of min. 250 x 250 x 1 mm

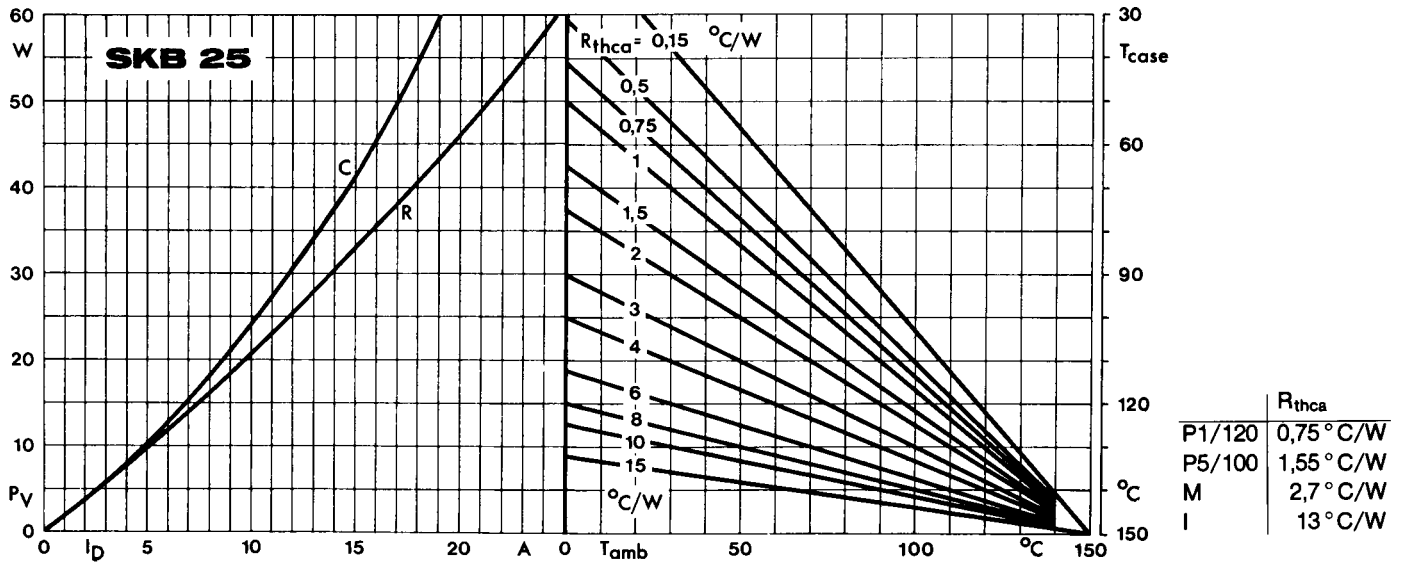

Fig. 3 a Power dissipation vs. output current and case temperature

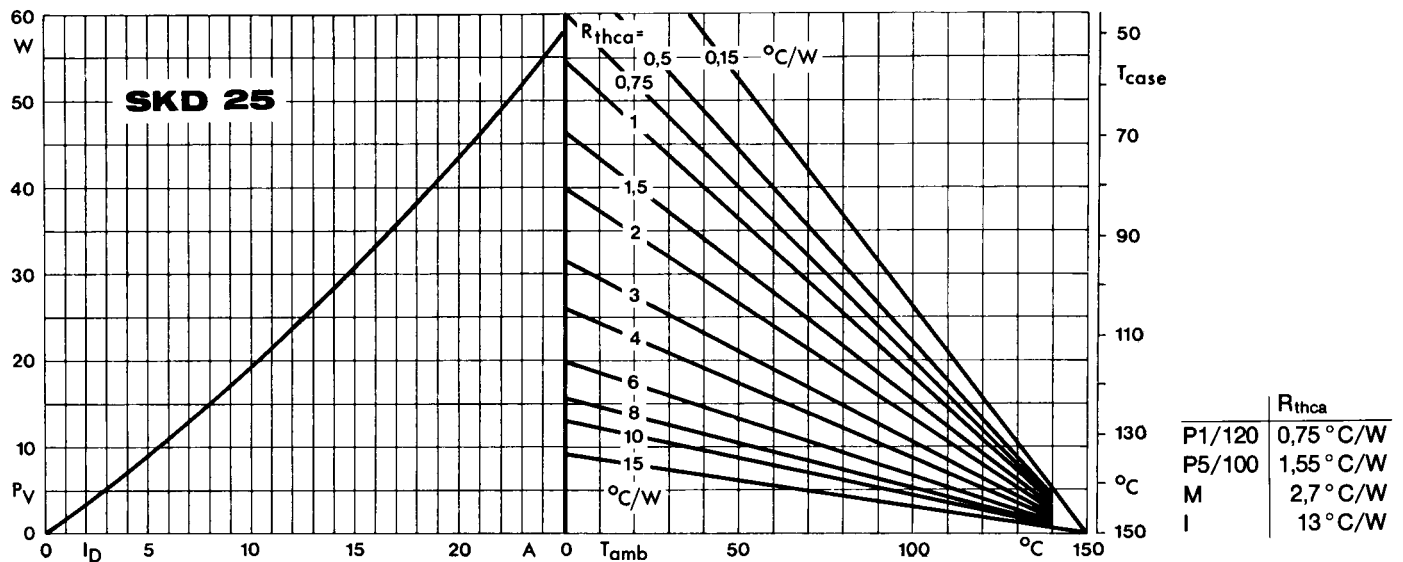

Fig. 3 b Power dissipation vs. output current and case temperature

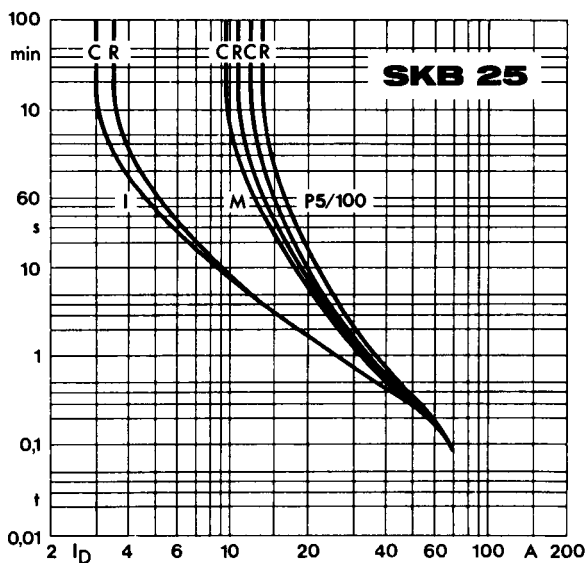

Fig. 6 a Rated overload current vs. time

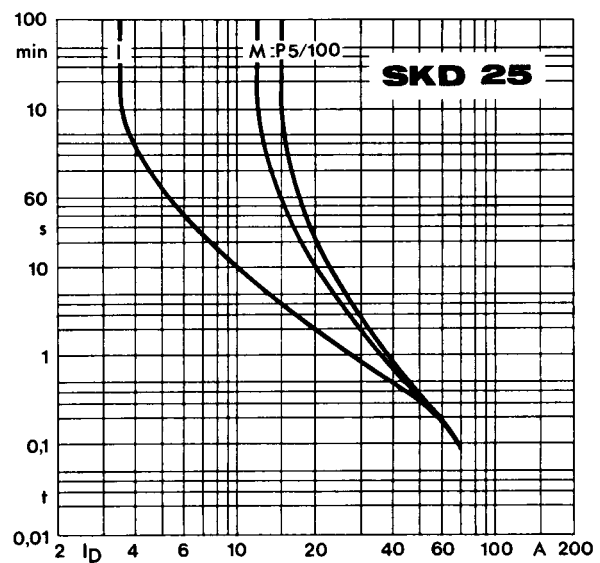

Fig. 6 b Rated overload current vs. time

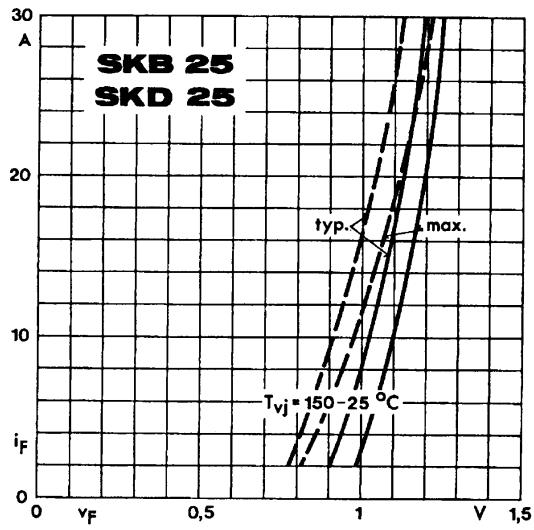
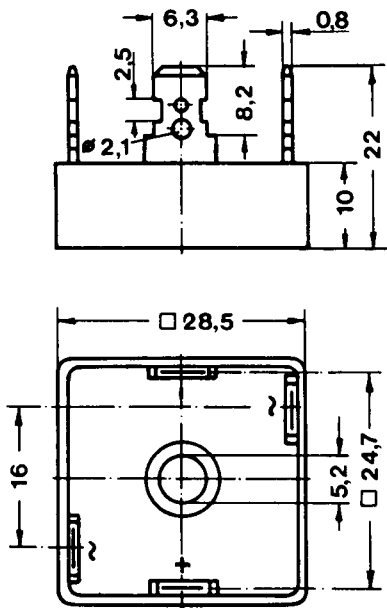

Fig. 9 Forward characteristics of a single diode

SKB 25
Case G 10



SKD 25
Case G 11

