

### THREE PHASE AC SWITCH

### Power Modules

#### Features

- Package fully compatible with the industry standard INT-A-pak power modules series
- High thermal conductivity package, electrically insulated case
- Outstanding number of power encapsulated components
- Excellent power volume ratio
- 4000 V<sub>RMS</sub> isolating voltage
- UL E78996 approved 

50 A  
90 A  
100 A

#### Description

A range of extremely compact, encapsulated three phase AC-switches offering efficient and reliable operation. They are intended for use in general purpose and heavy duty applications as control motor starter.

#### Major Ratings and Characteristics

Parameters	54MT.KB	94MT.KB	104MT.KB	Units
I <sub>O</sub>	50	90	100	A
@ T <sub>C</sub>	80	80	80	°C
I <sub>FSM</sub> @ 50Hz	390	950	1130	A
@ 60Hz	410	1000	1180	A
i <sup>2</sup> <sub>t</sub> @ 50Hz	770	4525	6380	A <sup>2</sup> s
@ 60Hz	700	4130	5830	A <sup>2</sup> s
i <sup>2</sup> <sub>t</sub> √t	7700	45250	63800	A <sup>2</sup> √s
V <sub>RRM</sub> range	800 to 1600			V
T <sub>STG</sub> range	-40 to 125			°C
T <sub>J</sub> range	-40 to 125			°C

## 54-94-104MT..KB Series

Bulletin I27504 08/97

International  
IRF Rectifier

### ELECTRICAL SPECIFICATIONS

#### Voltage Ratings

Type number	Voltage Code	$V_{RRM}$ , maximum repetitive peak reverse voltage V	$V_{RSM}$ , maximum non-repetitive peak reverse voltage V	$V_{DRM}$ , max. repetitive peak off-state voltage, gate open circuit V	$I_{RRM}/I_{DRM}$ max. @ $T_J = 125^\circ\text{C}$ mA
54MT..KB	80	800	900	800	20 *
	100	1000	1100	1000	
	120	1200	1300	1200	
	140	1400	1500	1400	
	160	1600	1700	1600	
94/104MT..KB	80	800	900	800	40 *
	100	1000	1100	1000	
	120	1200	1300	1200	
	140	1400	1500	1400	
	160	1600	1700	1600	

\* For single AC switch

#### Forward Conduction

Parameter	54MT.KB	94MT.KB	104MT.KB	Units	Conditions		
$I_O$ Maximum $I_{RMS}$ output current @ Case temperature	50	90	100	A	For all conduction angle		
	80	80	80	$^\circ\text{C}$			
$I_{TSM}$ Maximum peak, one-cycle forward, non-repetitive on state surge current	390	950	1130	A	t = 10ms	No voltage reappplied	Initial $T_J = T_{J \text{ max.}}$
	410	1000	1180		t = 8.3ms	reappplied	
	330	800	950		t = 10ms	100% $V_{RRM}$	
	345	840	1000		t = 8.3ms	reappplied	
$I^2t$ Maximum $I^2t$ for fusing	770	4525	6380	$\text{A}^2\text{s}$	t = 10ms	No voltage reappplied	$T_J = T_{J \text{ max.}}$
	700	4130	5830		t = 8.3ms	reappplied	
	540	3200	4510		t = 10ms	100% $V_{RRM}$	
	500	2920	4120		t = 8.3ms	reappplied	
$I^2\sqrt{t}$ Maximum $I^2\sqrt{t}$ for fusing	7700	45250	63800	$\text{A}^2\sqrt{\text{s}}$	t = 0.1 to 10ms, no voltage reappplied		
$V_{T(TO)1}$ Low level value of threshold voltage	1.16	0.99	0.99	V	$(16.7\% \times \pi \times I_{T(AV)} < I < \pi \times I_{T(AV)})$ , @ $T_J \text{ max.}$		
$V_{T(TO)2}$ High level value of threshold voltage	1.44	1.19	1.15	V	$(I > \pi \times I_{T(AV)})$ , @ $T_J \text{ max.}$		
$r_{T1}$ Low level value on-state slope resistance	12.54	4.16	3.90	$\text{m}\Omega$	$(16.7\% \times \pi \times I_{T(AV)} < I < \pi \times I_{T(AV)})$ , @ $T_J \text{ max.}$		
$r_{T2}$ High level value on-state slope resistance	11.00	3.56	3.48	$\text{m}\Omega$	$(I > \pi \times I_{T(AV)})$ , @ $T_J \text{ max.}$		
$V_{TM}$ Maximum on-state voltage drop	2.68	1.55	1.53	V	$I_{pk} = 150\text{A}$ , $T_J = 25^\circ\text{C}$ $t_p = 400\mu\text{s}$ single junction		
$di/dt$ Max. non-repetitive rate of rise of turned on current	150			$\text{A}/\mu\text{s}$	$T_J = 25^\circ\text{C}$ , from 0.67 $V_{DRM}$ , $I_{TM} = \pi \times I_{T(AV)}$ , $I_g = 500\text{mA}$ , $t_r < 0.5\mu\text{s}$ , $t_p > 6\mu\text{s}$		
$I_H$ Max. holding current	200			mA	$T_J = 25^\circ\text{C}$ , anode supply = 6V, resistive load, gate open circuit		
$I_L$ Max. latching current	400				$T_J = 25^\circ\text{C}$ , anode supply = 6V, resistive load		

**Blocking**

Parameter	54MT.KB	94MT.KB	104MT.KB	Units	Conditions
V <sub>INS</sub> RMS isolation voltage	4000			V	T <sub>J</sub> = 25°C all terminal shorted f = 50Hz, t = 1s
dv/dt Max. critical rate of rise of off-state voltage (*)	500			V/μs	T <sub>J</sub> = T <sub>J</sub> max., linear to 0.67 V <sub>DRM</sub> gate open circuit

(\*) Available with dv/dt = 1000V/μs, to complete code add S90 i.e. 104MT160KBS90.

**Triggering**

Parameter	54MT.KB	94MT.KB	104MT.KB	Units	Conditions
P <sub>GM</sub> Max. peak gate power	10			W	T <sub>J</sub> = T <sub>J</sub> max.
P <sub>G(AV)</sub> Max. average gate power	2.5				
I <sub>GM</sub> Max. peak gate current	2.5			A	
-V <sub>GT</sub> Max. peak negative gate voltage	10			V	
V <sub>GT</sub> Max. required DC gate voltage to trigger	4.0			V	T <sub>J</sub> = - 40°C
	2.5				T <sub>J</sub> = 25°C
	1.7				T <sub>J</sub> = 125°C
I <sub>GT</sub> Max. required DC gate current to trigger	270			mA	T <sub>J</sub> = - 40°C
	150				T <sub>J</sub> = 25°C
	80				T <sub>J</sub> = 125°C
V <sub>GD</sub> Max. gate voltage that will not trigger	0.25			V	@ T <sub>J</sub> = T <sub>J</sub> max., rated V <sub>DRM</sub> applied
I <sub>GD</sub> Max. gate current that will not trigger	6			mA	

**Thermal and Mechanical Specifications**

Parameter	54MT.KB	94MT.KB	104MT.KB	Units	Conditions
T <sub>J</sub> Max. junction operating temperature range	-40 to 125			°C	
T <sub>slg</sub> Max. storage temperature range	-40 to 125			°C	
R <sub>thJC</sub> Max. thermal resistance, junction to case	0.52	0.39	0.34	K/W	DC operation per single AC switch
	1.05	0.77	0.69		DC operation per junction
	0.56	0.40	0.36		180° Sine cond. angle per single AC switch
	1.12	0.80	0.72		180° Sine cond. angle per junction
R <sub>thCS</sub> Max. thermal resistance, case to heatsink	0.03			K/W	Per module Mounting surface smooth, flat and greased
T Mounting torque ± 10%	to heatsink	4 to 6		Nm	A mounting compound is recommended and the torque should be rechecked after a period of 3 hours to allow for the spread of the compound. Lubricated threads.
	to terminal	3 to 4			
wt Approximate weight	225			g	

## 54-94-104MT..KB Series

Bulletin I27504 08/97

International  
**IRF** Rectifier

### ΔR Conduction (per Junction)

(The following table shows the increment of thermal resistance  $R_{thJC}$  when devices operate at different conduction angles than DC)

Devices	Sinusoidal conduction @ $T_J$ max.					Rectangular conduction @ $T_J$ max.					Units
	180°	120°	90°	60°	30°	180°	120°	90°	60°	30°	
54MT.KB	0.072	0.085	0.108	0.152	0.233	0.055	0.091	0.117	0.157	0.236	K/W
94MT.KB	0.033	0.039	0.051	0.069	0.099	0.027	0.044	0.055	0.071	0.100	
104MT.KB	0.027	0.033	0.042	0.057	0.081	0.023	0.037	0.046	0.059	0.082	

### Ordering Information Table

Device Code						
10	4	MT	160	K	B	S90
①	②	③	④	⑤	⑥	
<b>1</b>	- Current rating code: 5 = 50 A (Avg) 9 = 90 A (Avg) 10 = 100 A (Avg)					
<b>2</b>	- AC Switch					
<b>3</b>	- Essential part number					
<b>4</b>	- Voltage code: Code x 10 = $V_{RRM}$ (See Voltage Ratings Table)					
<b>5</b>	- Generation II					
<b>6</b>	- Critical dv/dt: None = 500V/μs (Standard value) S90 = 1000V/μs (Special selection)					

**NOTE: To order the Optional Hardware see Bulletin I27900**

Outline Table (with optional barriers)

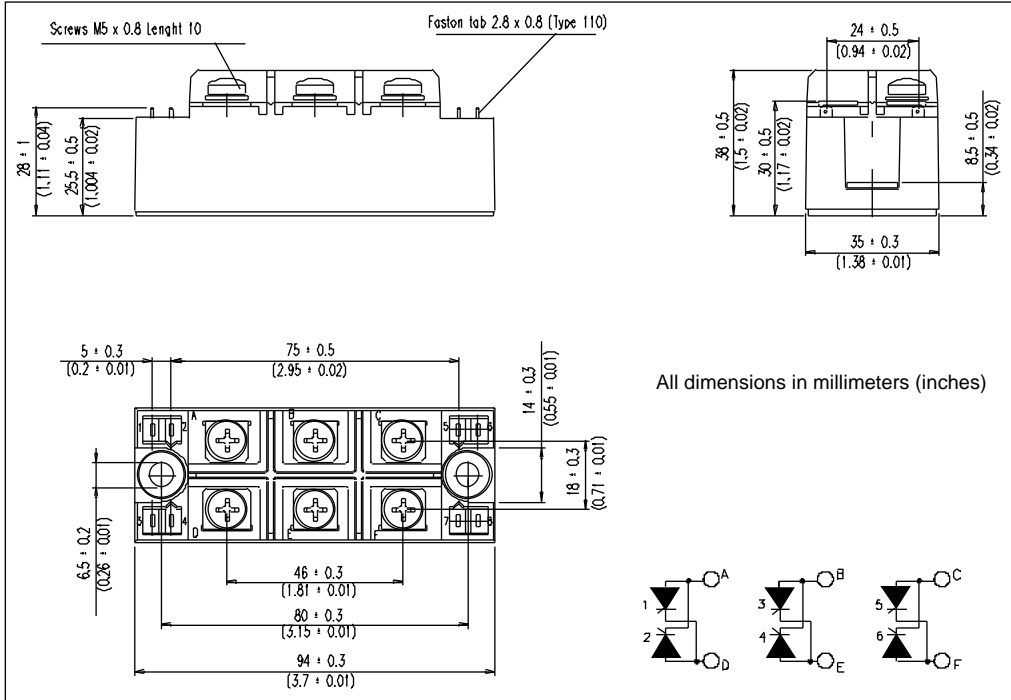

Outline Table (without optional barriers)

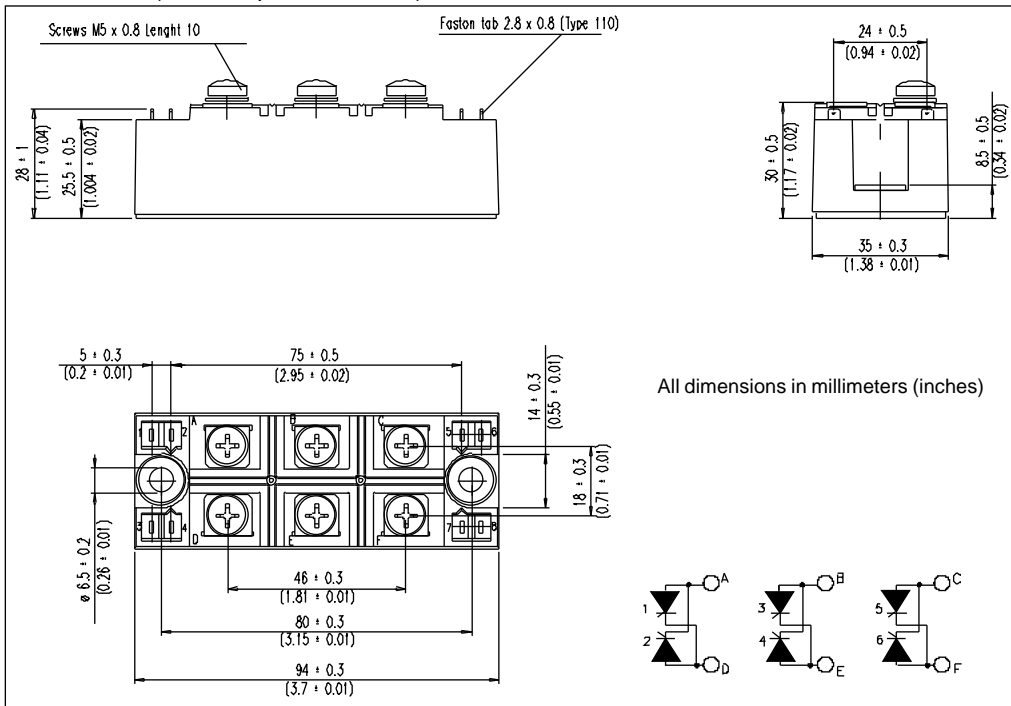

# 54-94-104MT..KB Series

Bulletin I27504 08/97

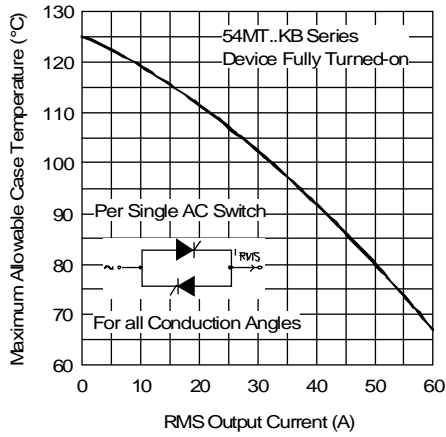

Fig. 1 - Current Ratings Characteristic

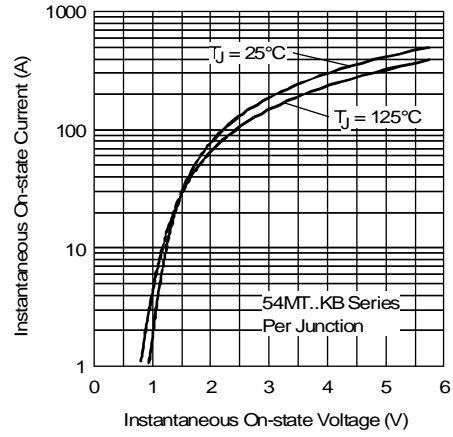

Fig. 2 - Forward Voltage Drop Characteristics

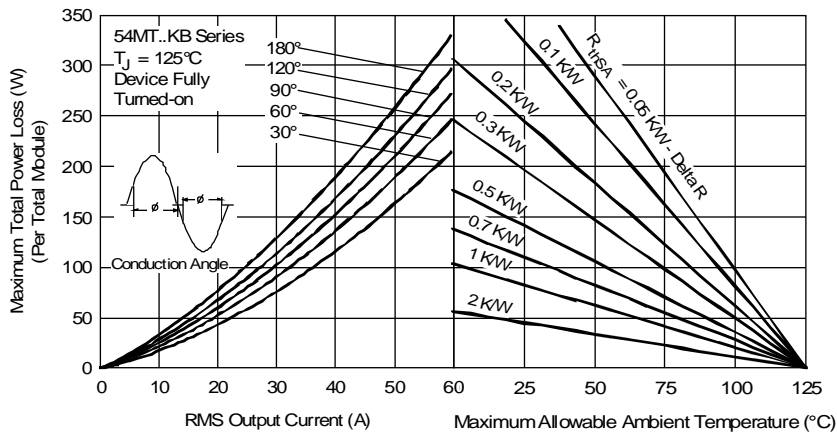

Fig. 3 - Total Power Loss Characteristics

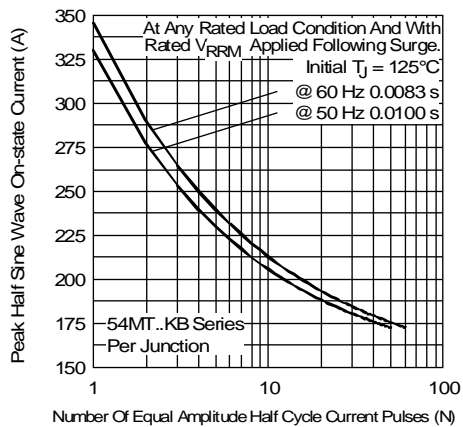

Fig. 4 - Maximum Non-Repetitive Surge Current

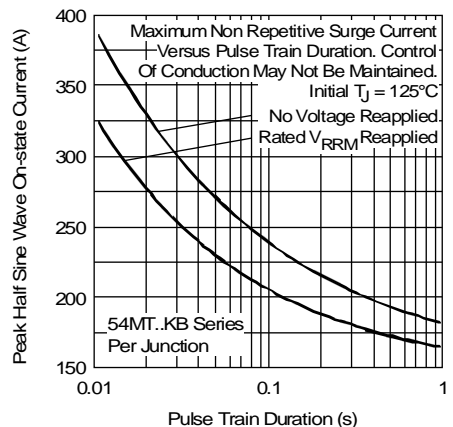

Fig. 5 - Maximum Non-Repetitive Surge Current

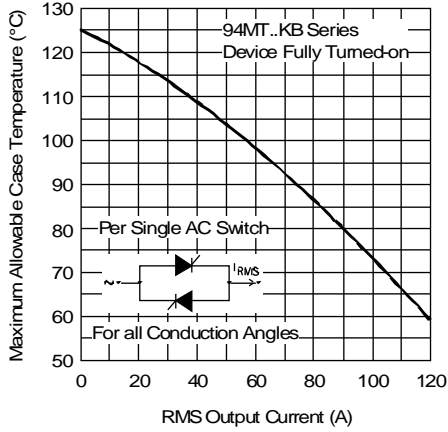

Fig. 6 - Current Ratings Characteristic

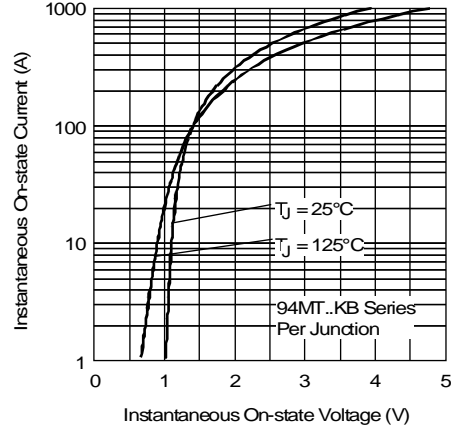

Fig. 7 - Forward Voltage Drop Characteristics

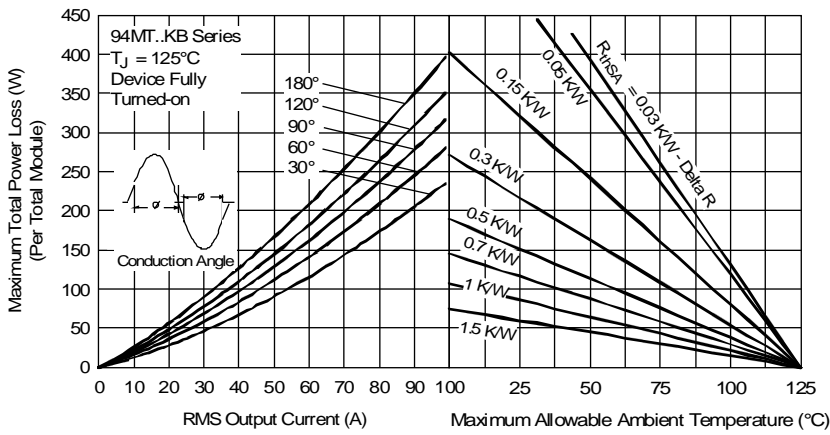

Fig. 8 - Total Power Loss Characteristics

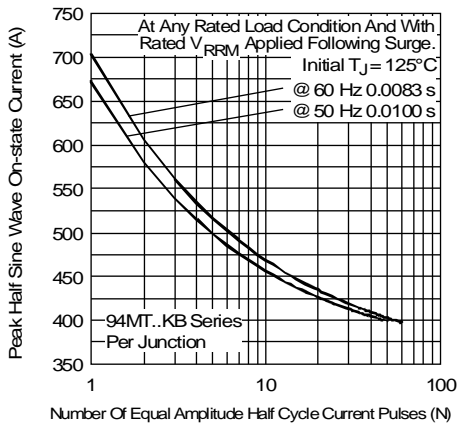

Fig. 9 - Maximum Non-Repetitive Surge Current

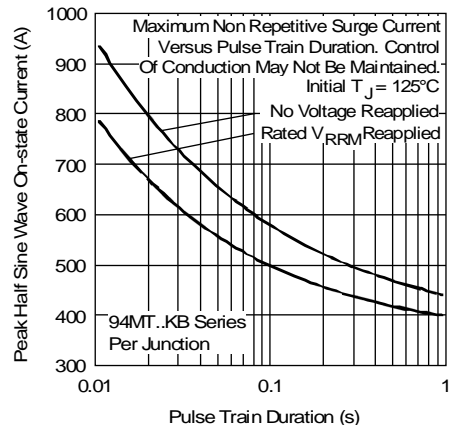

Fig. 10 - Maximum Non-Repetitive Surge Current

# 54-94-104MT..KB Series

Bulletin I27504 08/97

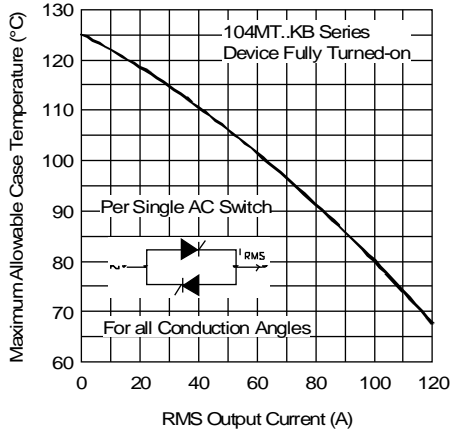

Fig. 11 - Current Ratings Characteristic

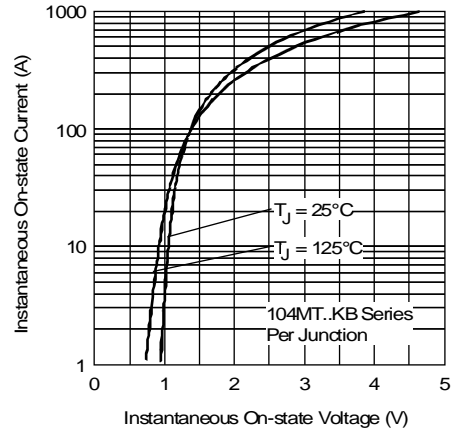

Fig. 12 - Forward Voltage Drop Characteristics

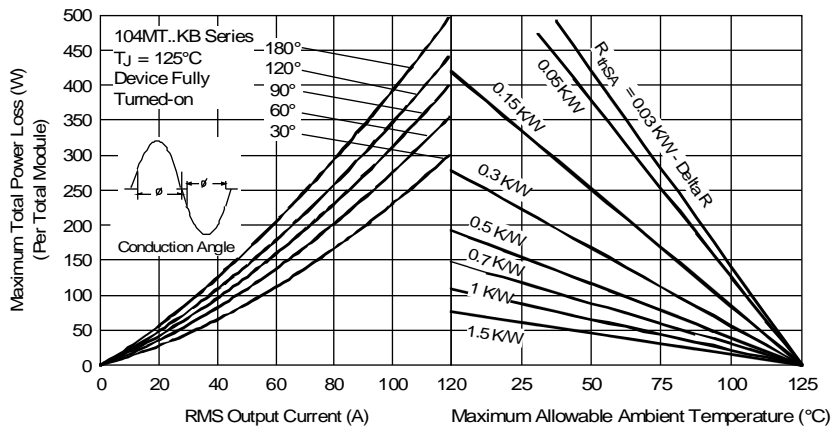

Fig. 13 - Total Power Loss Characteristics

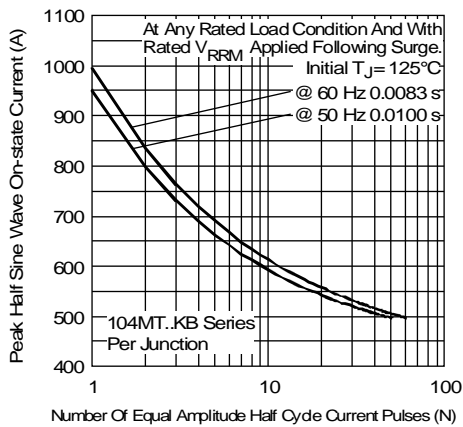

Fig. 14 - Maximum Non-Repetitive Surge Current

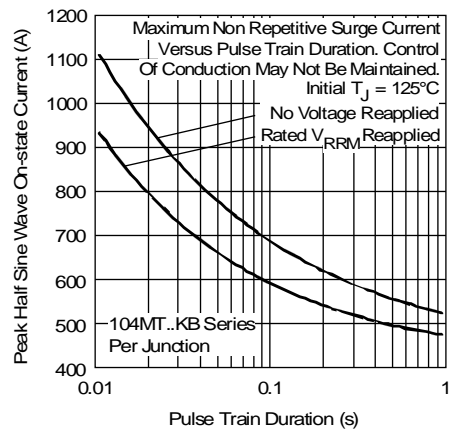

Fig. 15 - Maximum Non-Repetitive Surge Current



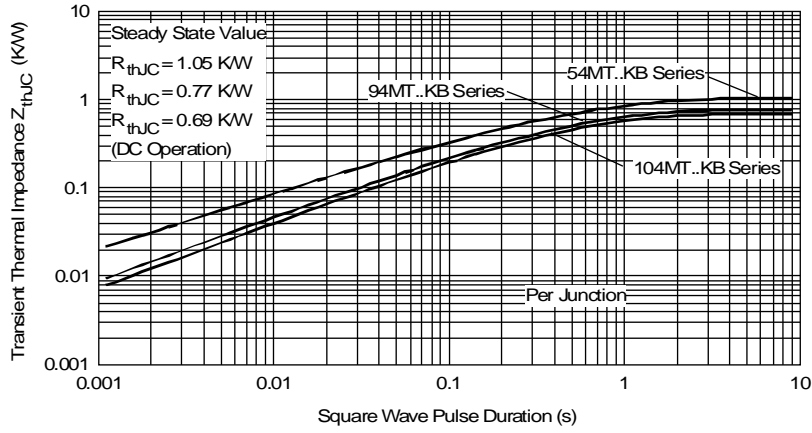

Fig. 16 - Thermal Impedance  $Z_{thJC}$  Characteristics

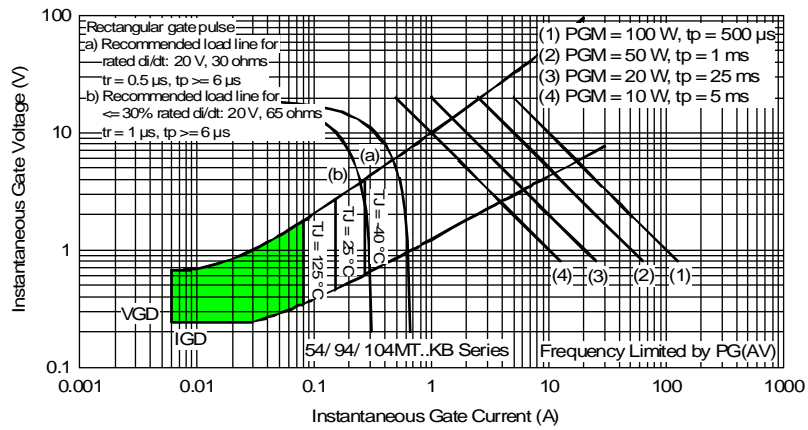

Fig. 17 - Gate Characteristics