

TENTATIVE

TOSHIBA InGaAlP LED

TLOU123, TLSU123, TLYU123

Panel Circuit Indicator

- InGaAlP LED
- All plastic mold type
- Colored transparent lens
- Lineup: 3 colors (red, orange, yellow)
- Suitable for high-brightness and less electricity consumption.
- All plastic molded lens, provides an excellent on-off contrast ratio.
- Applications: Backlight, light for decoration, switches, various indicator, personal equipment

Lineup

Product	Color	Material
TLOU123	Orange	InGaAlP
TLSU123	Red	InGaAlP
TLYU123	Yellow	InGaAlP

Unit in mm

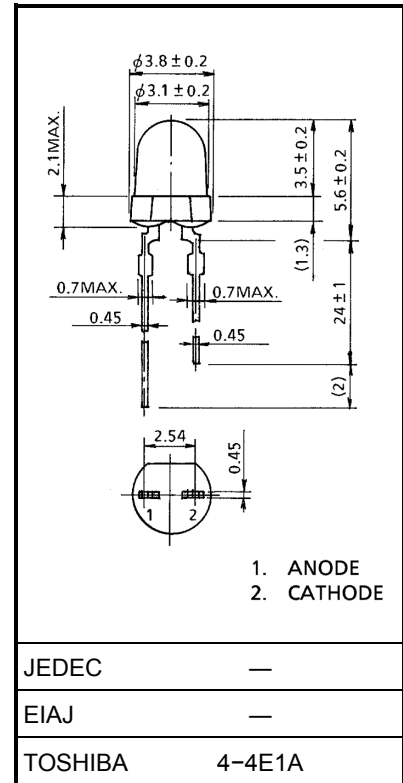

Weight: 0.14 g

Maximum Ratings (Ta = 25°C)

Product	Forward Current I _F (mA)	Reverse Voltage V _R (V)	Power Dissipation P _D (mW)	Operating Temperature T _{opr} (°C)	Storage Temperature T _{stg} (°C)
TLOU123	30	4	72	-20~75	-30~100
TLSU123	30	4	72	-20~75	-30~100
TLYU123	30	4	75	-20~75	-30~100

Electrical And Optical Characteristics (Ta = 25°C)

Product	Typ. Emission Wavelength			Luminous Intensity I _v			Forward Voltage V _F			Reverse Current I _R	
	λ _p	Δλ	I _F	Min	Typ.	I _F	Typ.	Max	I _F	Max	V _R
TLOU123	612	15	20	85	400	20	2.0	2.4	20	50	4
TLSU123	636	17	20	85	270	20	2.0	2.4	20	50	4
TLYU123	590	13	20	85	220	20	2.1	2.5	20	50	4
Unit	nm		mA	mcd		mA	V		mA	μA	V

Precaution

Please be careful of the followings

- Soldering temperature: 260°C max Soldering time: 3 s max
(soldering portion of lead: Up to 2 mm from the body of the device)
- If the lead is formed, the lead should be formed up to 5 mm from the body of the device without forming stress to the resin. Soldering should be performed after lead forming.
- This visible LED lamp also emits some IR light. If a photodetector is located near the LED lamp, please ensure that it will not be affected by this IR light.

TLOU123

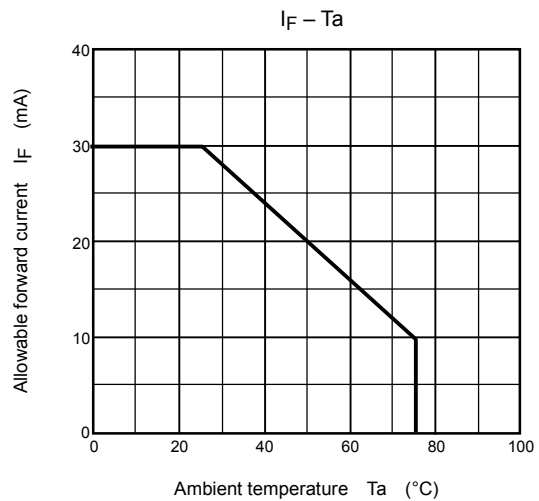
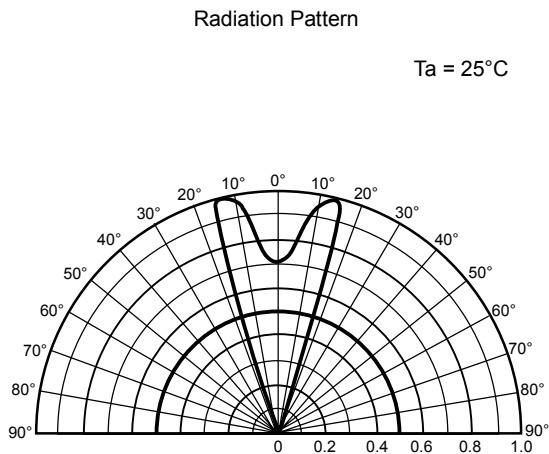
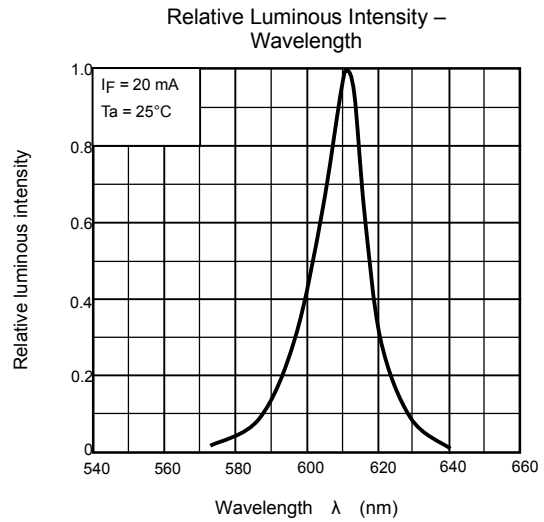
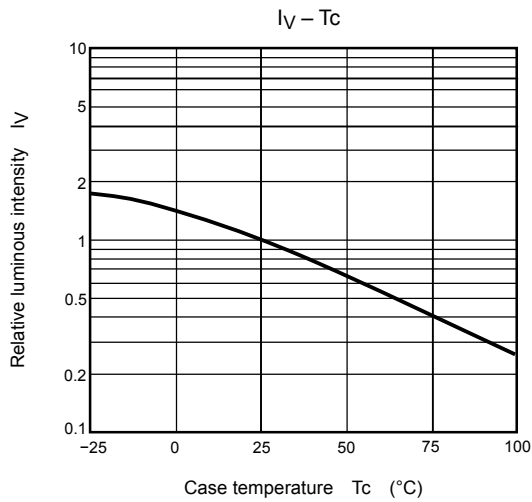
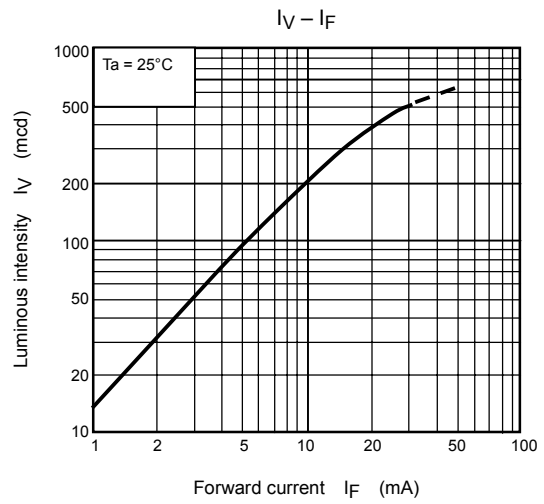
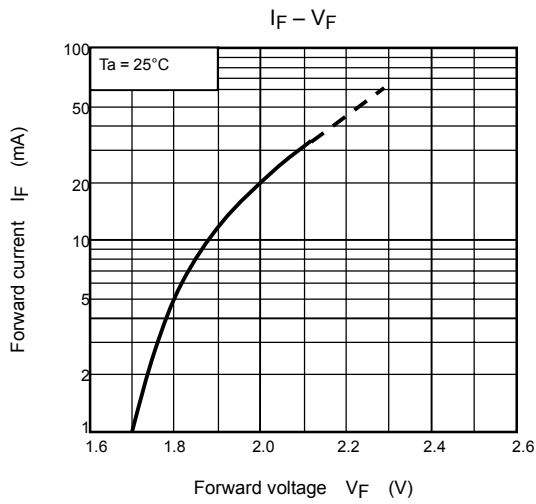

TLSU123

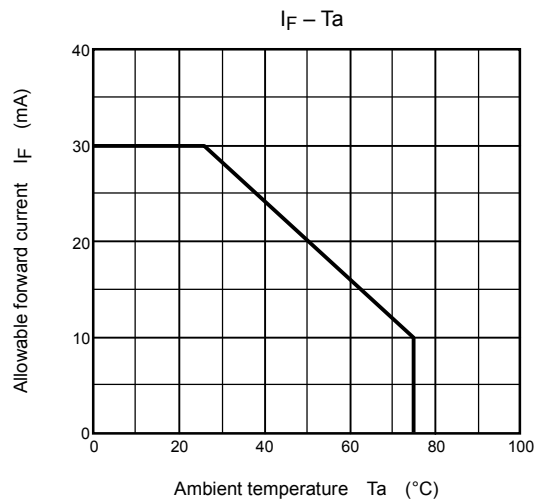
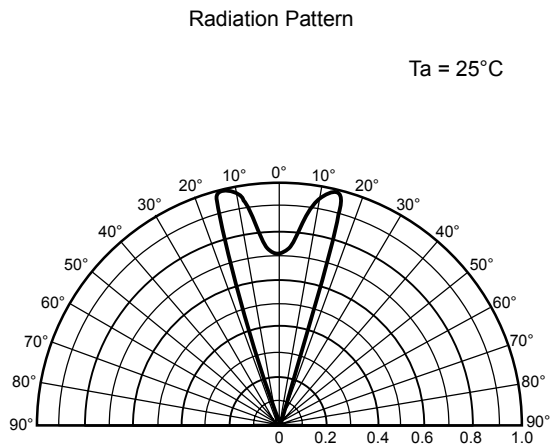
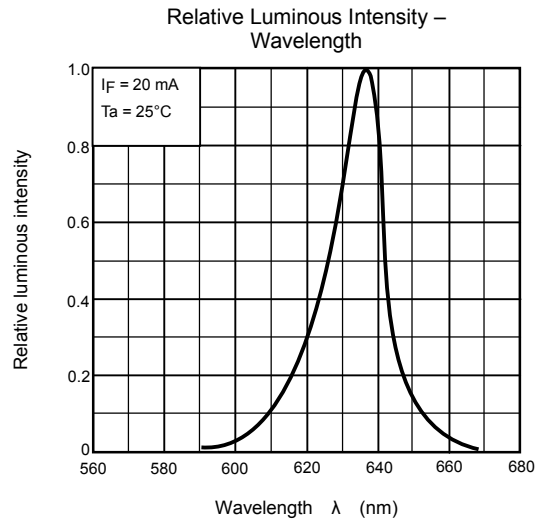
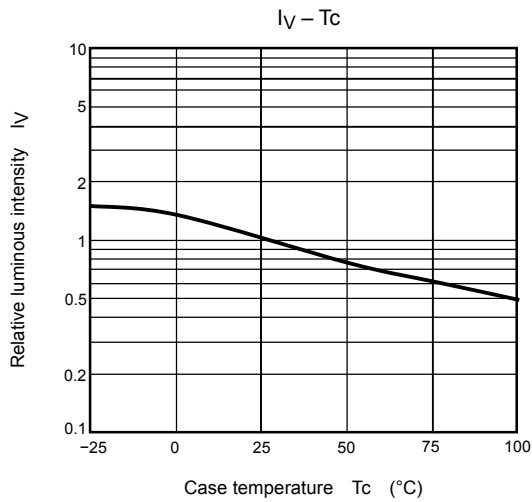
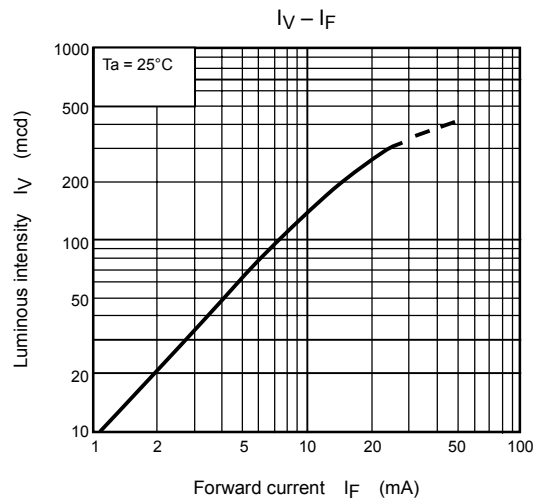
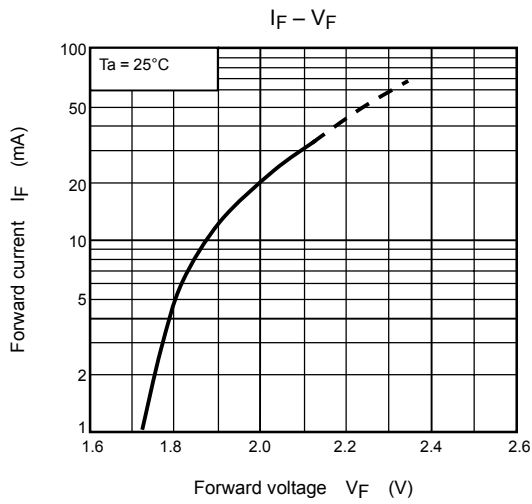

TLYU123

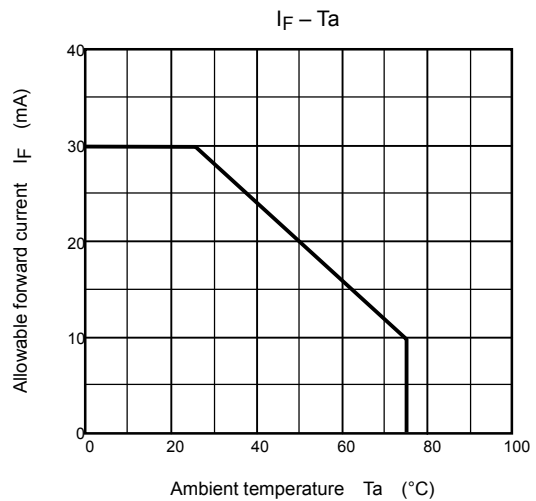
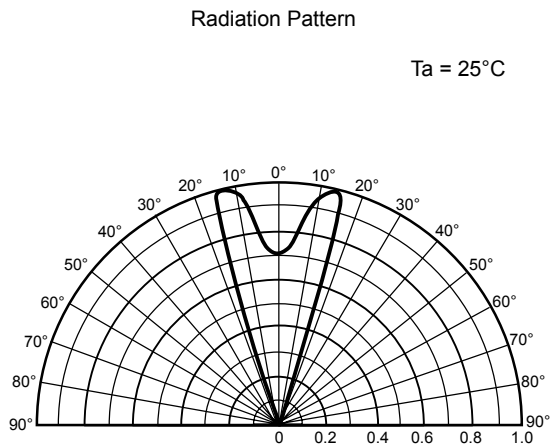
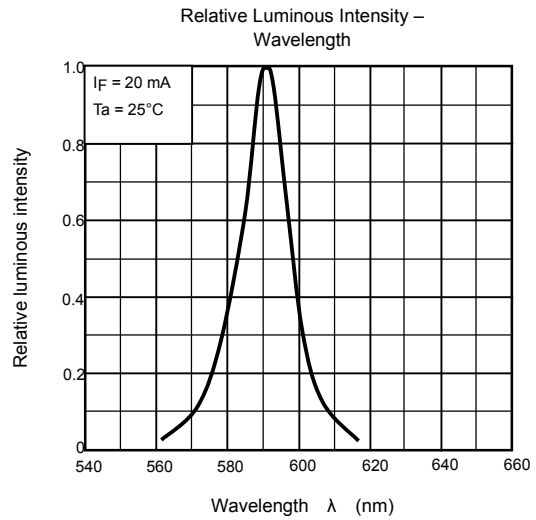
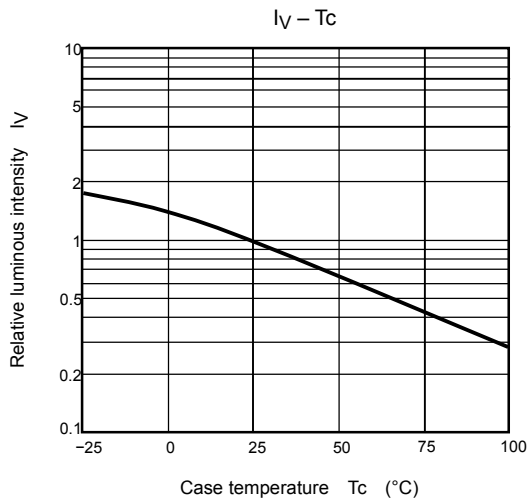
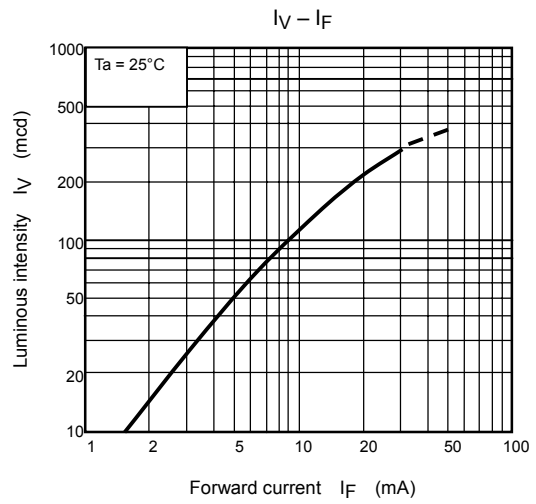
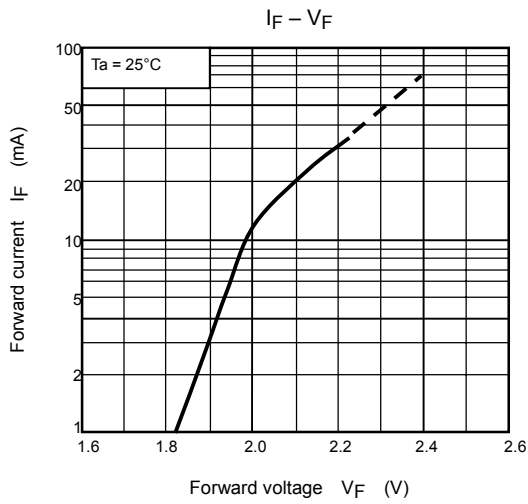

RESTRICTIONS ON PRODUCT USE

000707EAC

- TOSHIBA is continually working to improve the quality and reliability of its products. Nevertheless, semiconductor devices in general can malfunction or fail due to their inherent electrical sensitivity and vulnerability to physical stress. It is the responsibility of the buyer, when utilizing TOSHIBA products, to comply with the standards of safety in making a safe design for the entire system, and to avoid situations in which a malfunction or failure of such TOSHIBA products could cause loss of human life, bodily injury or damage to property.
In developing your designs, please ensure that TOSHIBA products are used within specified operating ranges as set forth in the most recent TOSHIBA products specifications. Also, please keep in mind the precautions and conditions set forth in the "Handling Guide for Semiconductor Devices," or "TOSHIBA Semiconductor Reliability Handbook" etc..
- The TOSHIBA products listed in this document are intended for usage in general electronics applications (computer, personal equipment, office equipment, measuring equipment, industrial robotics, domestic appliances, etc.). These TOSHIBA products are neither intended nor warranted for usage in equipment that requires extraordinarily high quality and/or reliability or a malfunction or failure of which may cause loss of human life or bodily injury ("Unintended Usage"). Unintended Usage include atomic energy control instruments, airplane or spaceship instruments, transportation instruments, traffic signal instruments, combustion control instruments, medical instruments, all types of safety devices, etc.. Unintended Usage of TOSHIBA products listed in this document shall be made at the customer's own risk.
- Gallium arsenide (GaAs) is a substance used in the products described in this document. GaAs dust and fumes are toxic. Do not break, cut or pulverize the product, or use chemicals to dissolve them. When disposing of the products, follow the appropriate regulations. Do not dispose of the products with other industrial waste or with domestic garbage.

The information contained herein is presented only as a guide for the applications of our products. No responsibility is assumed by TOSHIBA CORPORATION for any infringements of intellectual property or other rights of the third parties which may result from its use. No licen