

TOSHIBA LED Lamps

TLRMV1020(T14), TLSV1020(T14), TLOV1020(T14), TLYV1020(T14), TLGV1020(T14), TLPGV1020(T14)

Panel Circuit Indicator

- Surface-mount devices
- 1.6 (L) × 0.8 (W) × 0.6 (H) mm
- InGaAlP LEDs
- High luminous intensity and low power consumption
 - Drive current conditions: 2 mA and 5 mA
 - 2-mA drive: general backlighting
 - 5-mA drive: high-brightness applications
- Suitable for backlighting
- Colors: red, orange, yellow, green, pure green
- Standard embossed tape packing
 - 4-mm pitch: T14 (4000/reel)
- Applications: Backlighting (mobile phones, LCD displays, switching displays)
 - Indicators for compact devices and battery-driven devices etc.

Unit: mm

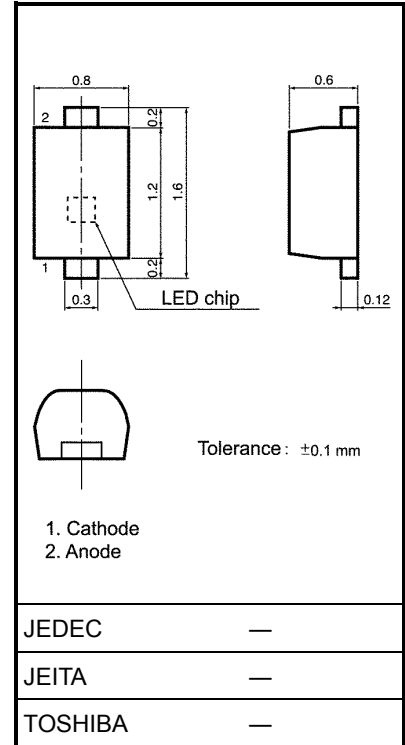

Weight: 0.001 g (typ.)

Color and Material

Product Name	Color	Material
TLRMV1020	Red	InGaAlP
TLSV1020	Red	
TLOV1020	Orange	
TLYV1020	Yellow	
TLGV1020	Green	
TLPGV1020	Pure Green	

Maximum Ratings (Ta = 25°C)

Product Name	Forward Current I _F (mA)	Reverse Voltage V _R (V)	Power Dissipation P _D (mW)	Operating Temperature T _{opr} (°C)	Storage Temperature T _{stg} (°C)
TLRMV1020	15	4	34.5	-40~100	-40~100
TLSV1020					
TLOV1020					
TLYV1020					
TLGV1020					
TLPGV1020					

Electrical Characteristics (Ta = 25°C)

Product Name	Forward Voltage V _F			Reverse Current I _R		
	Min	Typ.	Max	I _F	Max	V _R
TLRMV1020	—	2.0	2.3	5	10	4
TLSV1020	—	2.0	2.3			
TLOV1020	—	2.0	2.3			
TLYV1020	—	2.0	2.3			
TLGV1020	—	2.0	2.3			
TLPGV1020	—	2.0	2.3			
Unit	V			mA	μA	V

Optical Characteristics–1 (Ta = 25°C)

Luminous intensity specifications are given for both 2-mA-drive devices and 5-mA-drive devices. 2-mA-drive devices are used in low-power-consumption applications. Their product numbers have the suffix “2MA”, as shown below.

Standard specification (5-mA type): TL□V1020(T14)

“2MA” specification (2-mA type): TL□V1020(T14, 2MA)

(1) Standard specification (5 mA)

Product Name	Luminous Intensity I _v			
	Min	Typ.	Max	I _F
TLRMV1020	4.76	15	—	5
TLSV1020	8.5	30	—	
TLOV1020	8.5	38	—	
TLYV1020	8.5	25	—	
TLGV1020	4.76	14	—	
TLPGV1020	1.53	3.5	—	
Unit	mcd			mA

(2) 2MA Specification (2 mA)

Product Name	Luminous Intensity I _v			
	Min	Typ.	Max	I _F
TLRMV1020	2.72	6	—	2
TLSV1020	4.76	12	—	
TLOV1020	4.76	14	—	
TLYV1020	4.76	9	—	
TLGV1020	2.72	7	—	
TLPGV1020	0.85	1.5	—	
Unit	mcd			mA

Optical Characteristics–2 (Ta = 25°C)

Product Name	Emission Spectrum							
	Peak Emission Wavelength λ _p			Dominant Wavelength λ _d				
	Min	Typ.	Max	Δλ Typ.	Min	Typ.	Max	
TLRMV1020	—	636	—	17	—	626	—	5
TLSV1020	—	623	—	17	—	613	—	
TLOV1020	—	612	—	15	—	605	—	
TLYV1020	—	590	—	13	—	587	—	
TLGV1020	—	574	—	11	—	571	—	
TLPGV1020	—	562	—	11	—	558	—	
Unit	nm			nm	nm			mA

Note: The visible LED lamp also emits some IR light.

If a photodetector is located near the LED lamp, please ensure that it will not be affected by the IR light.

TLRMV1020

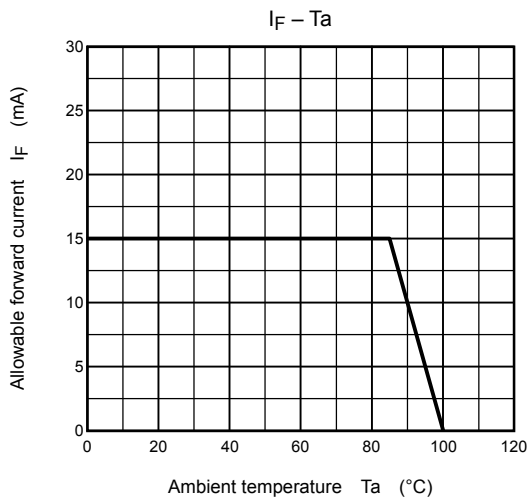
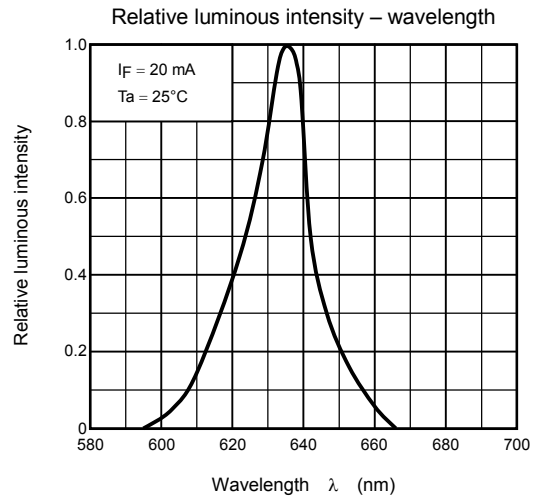
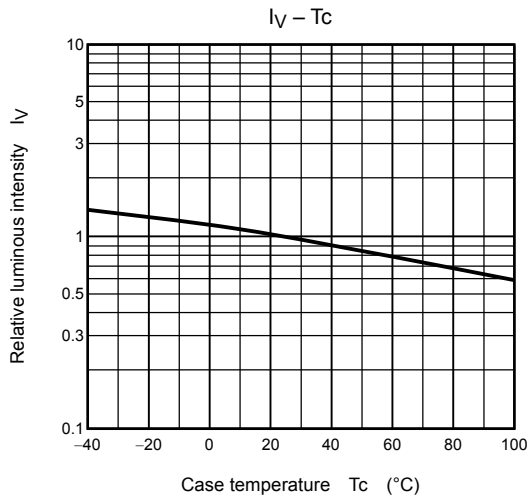
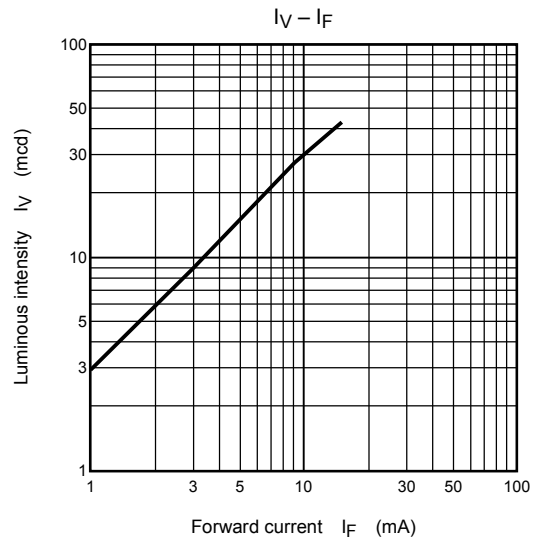
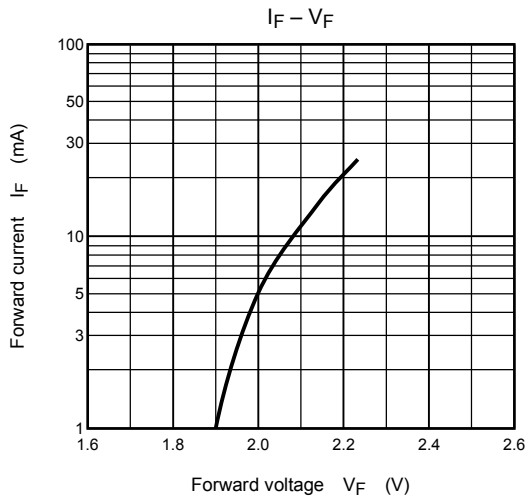

TLSV1020

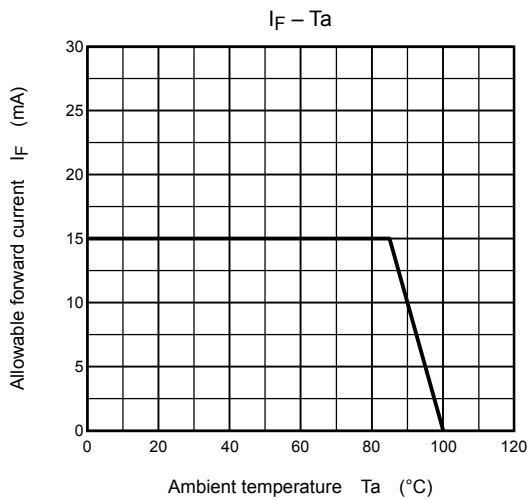
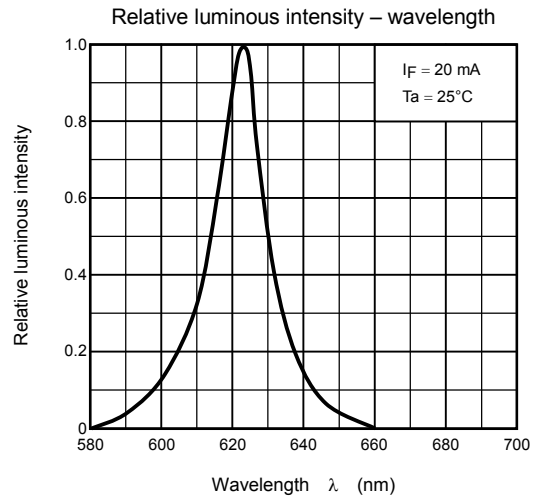
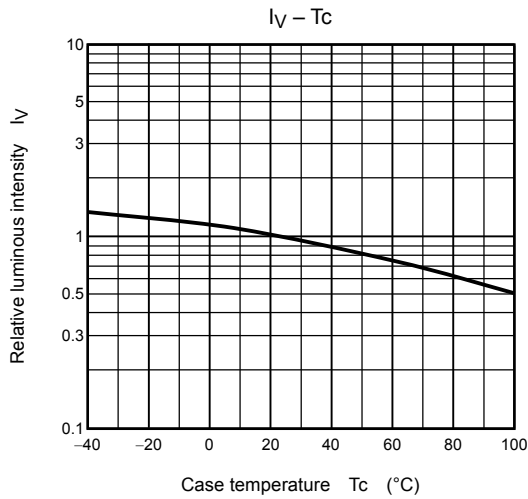
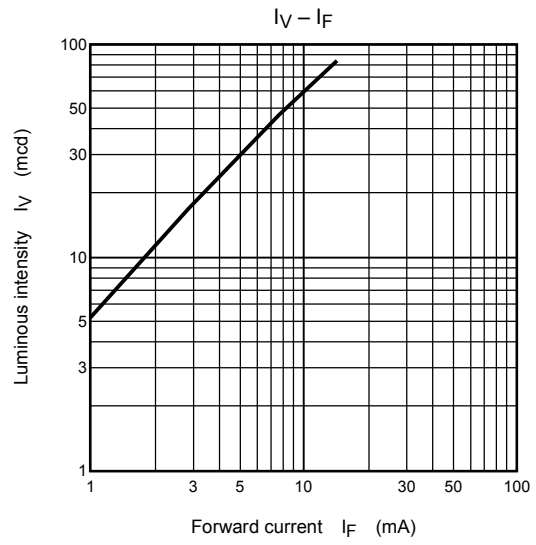
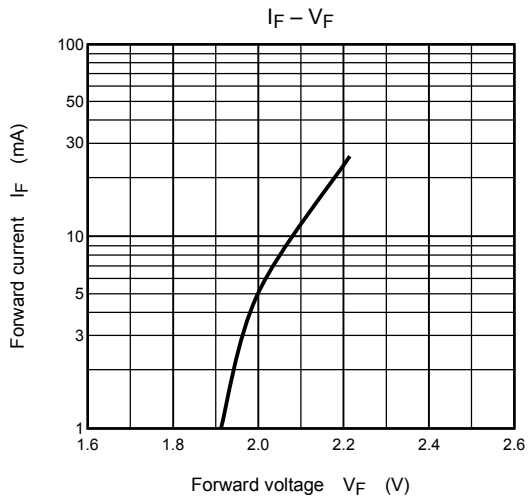

TLOV1020

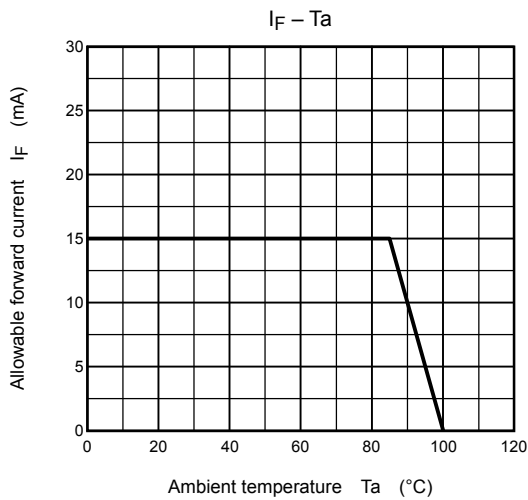
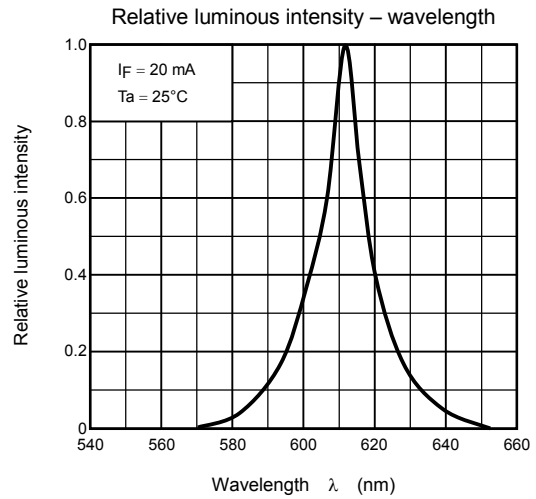
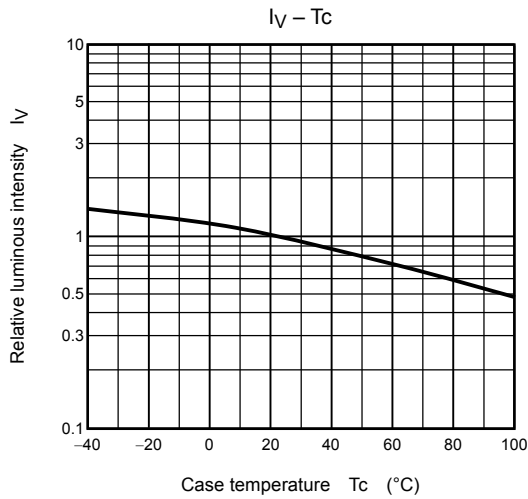
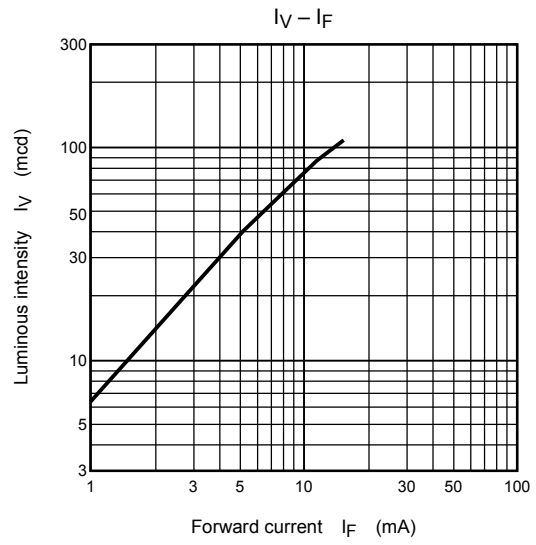
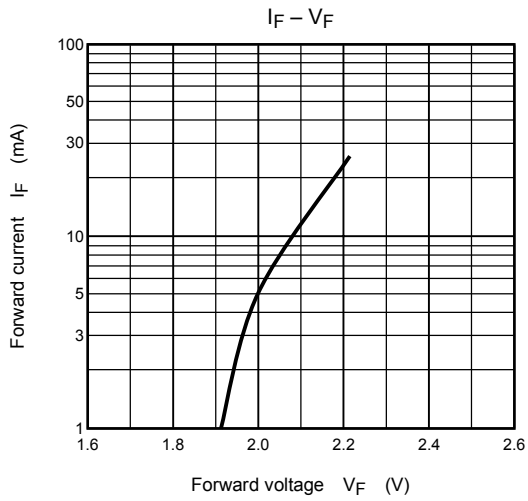

TLYV1020

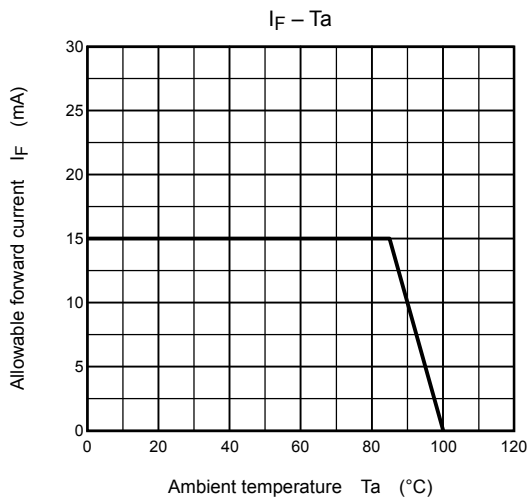
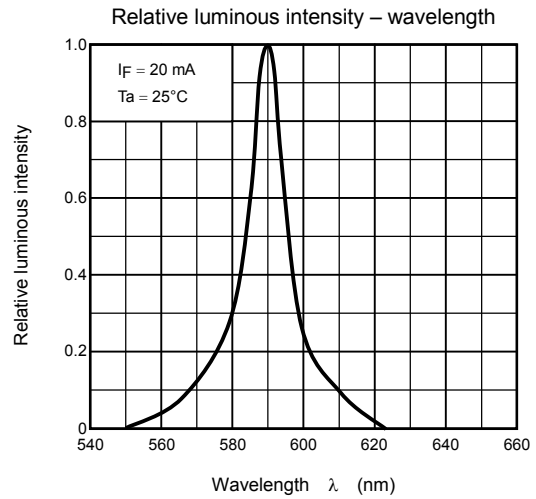
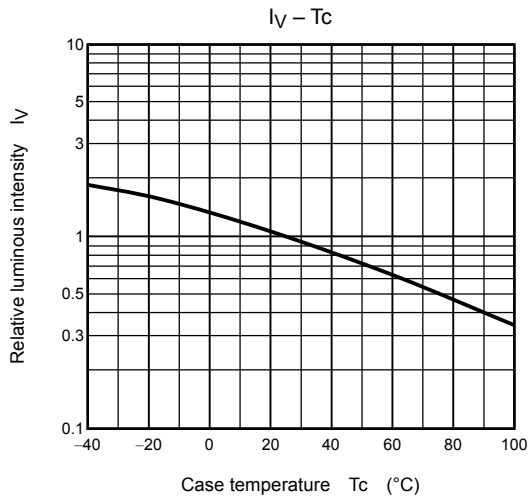
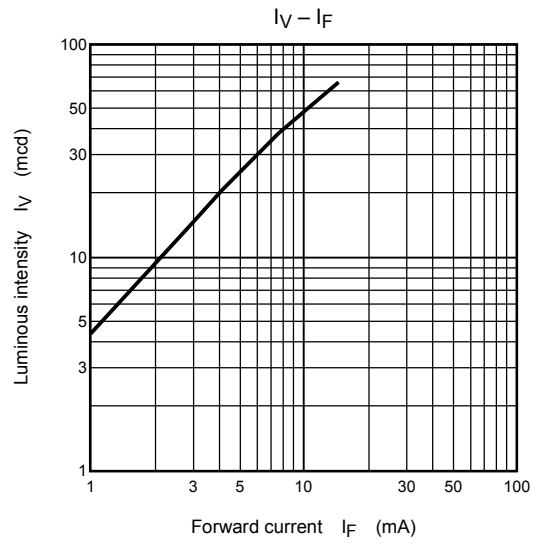
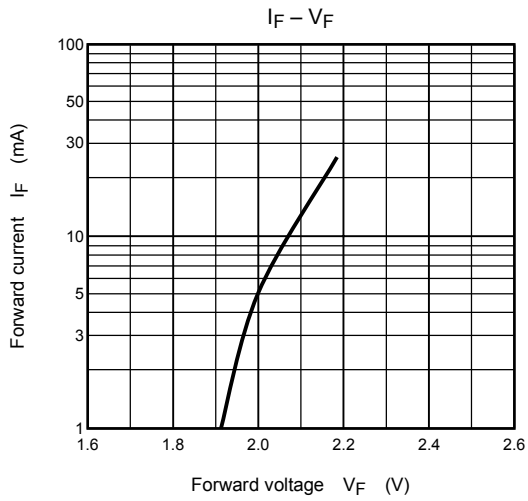

TLGV1020

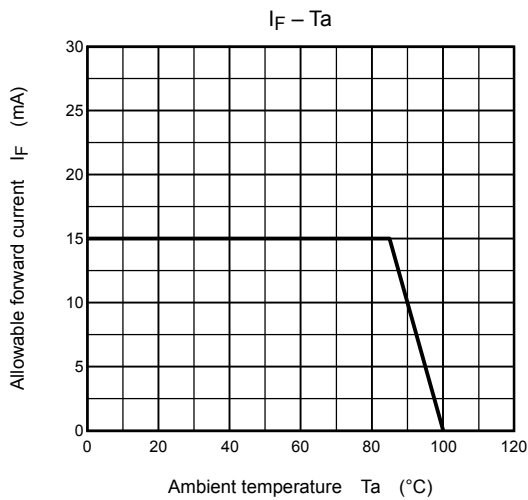
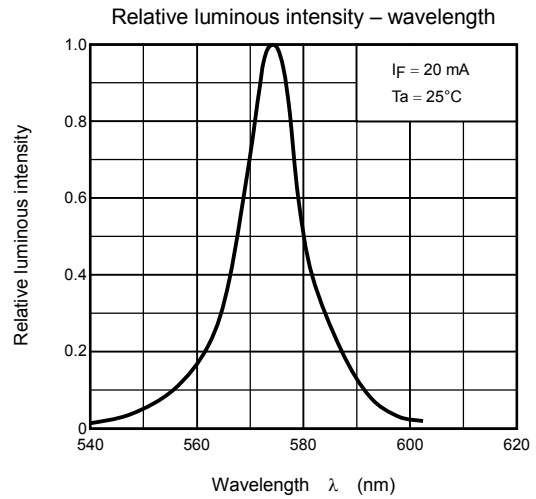
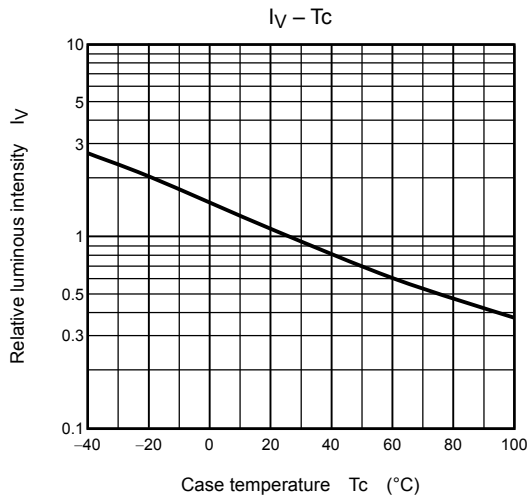
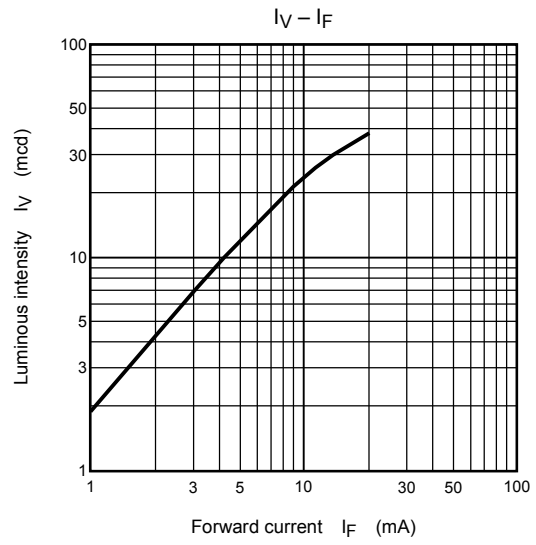
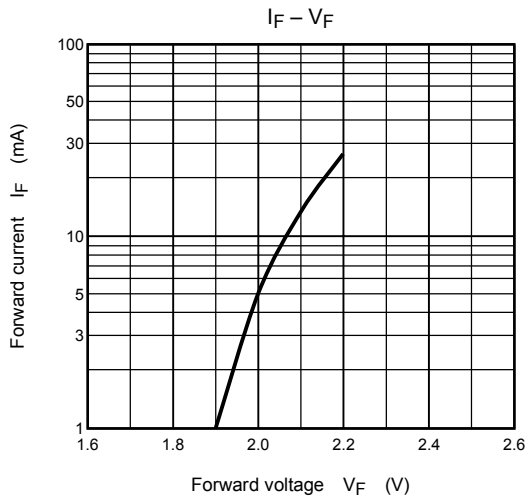

TLPGV1020

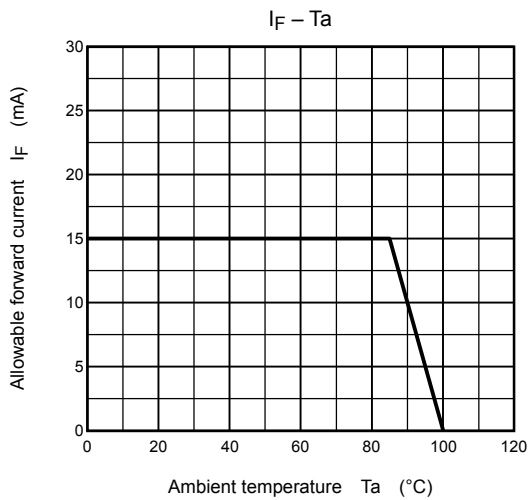
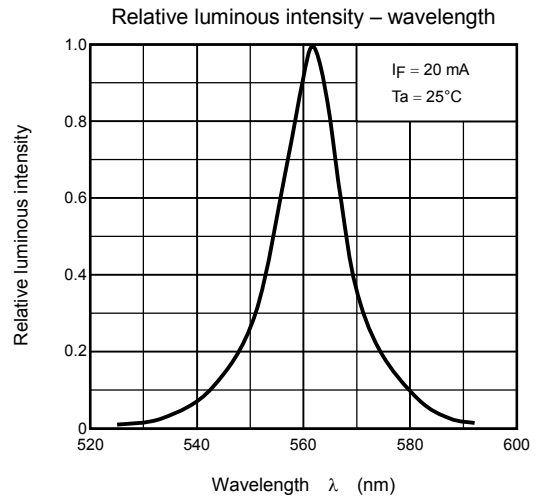
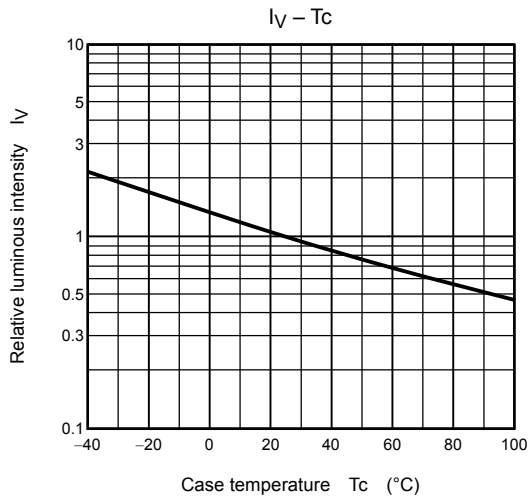
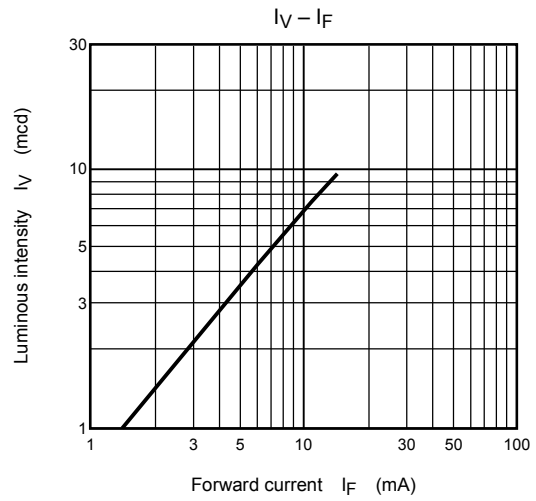
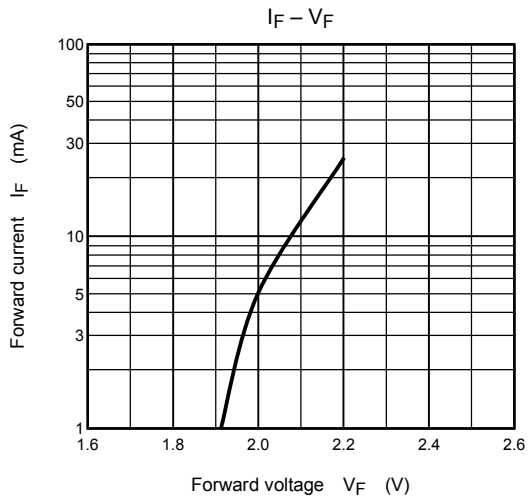

Radiation Pattern

Vertical to polarity

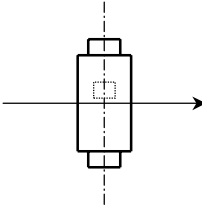
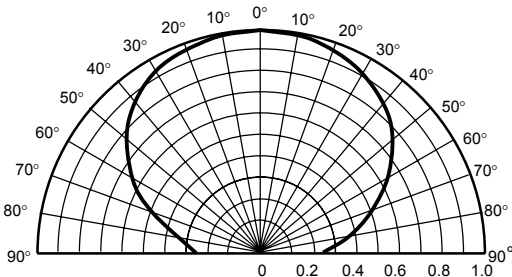

Horizontal to polarity

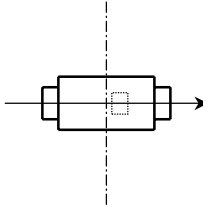
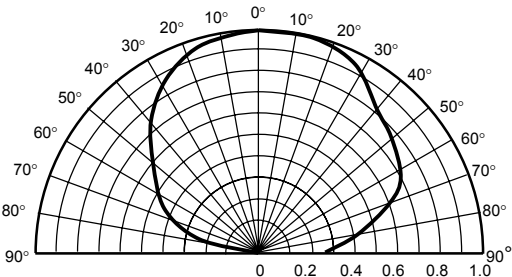

Packaging

These LED devices are packed in an aluminum envelope with a silica gel and a moisture indicator to avoid moisture absorption. The optical characteristics of the devices may be affected by exposure to moisture in the air before soldering and they should therefore be stored under the following conditions:

1. This moisture proof bag may be stored unopened within 12 months at the following conditions.
 Temperature: 5°C~30°C
 Humidity: 90% (max)
2. After opening the moisture proof bag, the devices should be assembled within 168 hours in an environment of 5°C to 30°C/60% RH or below.
3. If upon opening, the moisture indicator card shows humidity 30% or above (Color of indication changes to pink) or the expiration date has passed, the devices should be baked in taping with reel.
 After baking, use the baked devices within 72 hours, but perform baking only once.
 Baking conditions: 60±5°C, for 12 to 24 hours.
 Expiration date: 12 months from sealing date, which is imprinted on the same side as this label affixed.
4. Repeated baking can cause the peeling strength of the taping to change, then leads to trouble in mounting. Furthermore, prevent the devices from being destructed against static electricity for baking of it.
5. If the packing material of laminate would be broken, the airtightness would deteriorate. Therefore, do not throw or drop the packed devices.

Mounting Method

Soldering

- Reflow soldering

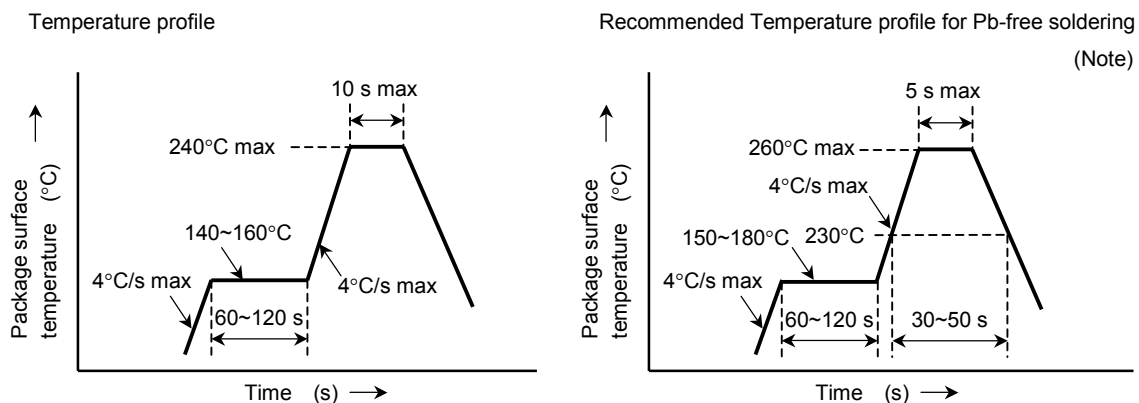

- Please perform the first reflow soldering with reference to the above temperature profile and within 168 h of opening the package.
- Second reflow soldering
 In case of second reflow soldering should be performed within 168 h of the first reflow under the above conditions.
 Storage conditions before the second reflow soldering: 30°C, 60% RH max
- Do not perform flow soldering.
- Make any necessary soldering corrections manually.
 (only once at each soldering point)
 Soldering iron: 25 W
 Temperature : 300°C or less
 Time : within 3 s

Note: Temperature profile for soldering using Pb-free solder.

However, please note that this product's leads are using Pb, because they have plated with solder. As of September 2001, Toshiba has begun to develop products intended for Pb-free soldering.

Recommended soldering pattern

(Unit: mm)

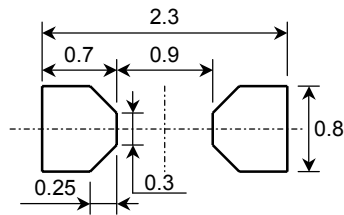

Cleaning

When cleaning after soldering is required, Toshiba recommends the following conditions:

Soldering iron : Less than 225W

Temperature : Lower than 300°C

Time : Within 3 s (Up to 1 time per place)

Precaution when mounting

Do not apply force to the plastic part of the LED under high-temperature conditions.

To avoid damaging the LED plastic do not apply friction using hard materials.

When installing the PCB in a product, ensure that the device does not come into contact with other components.

Tape Specifications

1. Product number format

The type of package used for shipment is denoted by a symbol suffix after the product number. The method of classification is as below. (this method, however does not apply to products whose electrical characteristics differ from standard Toshiba specifications)

(1) Tape Type: T14 (4-mm pitch)

(2) Example

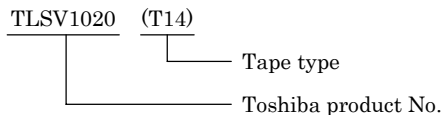

2. Handling precautions

Tape material protected against static electricity. However, static electricity may occur depending on quantity of charged static electricity and a device may attach to a tape, or a device may be unstable when peeling a tape cover.

- (a) Since tape materials may accumulate an electrostatic charge, use an ionizer to neutralize the ambient air.
- (b) For transport and temporary storage of devices, use containers (boxes and bags) and jigs that are made of anti-static materials or of materials which dissipate electrostatic charge.

3. Tape dimensions

(Unit: mm)

Item	Symbol	Value	Tolerance
Carrier tape	Width	W	±0.2
	Thickness	t ₁	±0.05
Feed hole	Diameter	D ₀	±0.1
	Pitch	P ₀	±0.1
	Position	E	±0.1
Distance from center line	Vertical Direction (1)	P ₁	±0.1
	Vertical Direction (2)	P ₂	±0.1
	Horizontal Direction	F	±0.1

Item	Symbol	Value	Tolerance
Cavity	Length	B ₁	±0.05
		B	±0.05
Cavity	Width	A	±0.05
		A ₁	±0.05
Cavity	Depth	t ₂	(0.85)
		t ₃	±0.05
Cavity	Diameter of mark hole	D ₁	±0.1

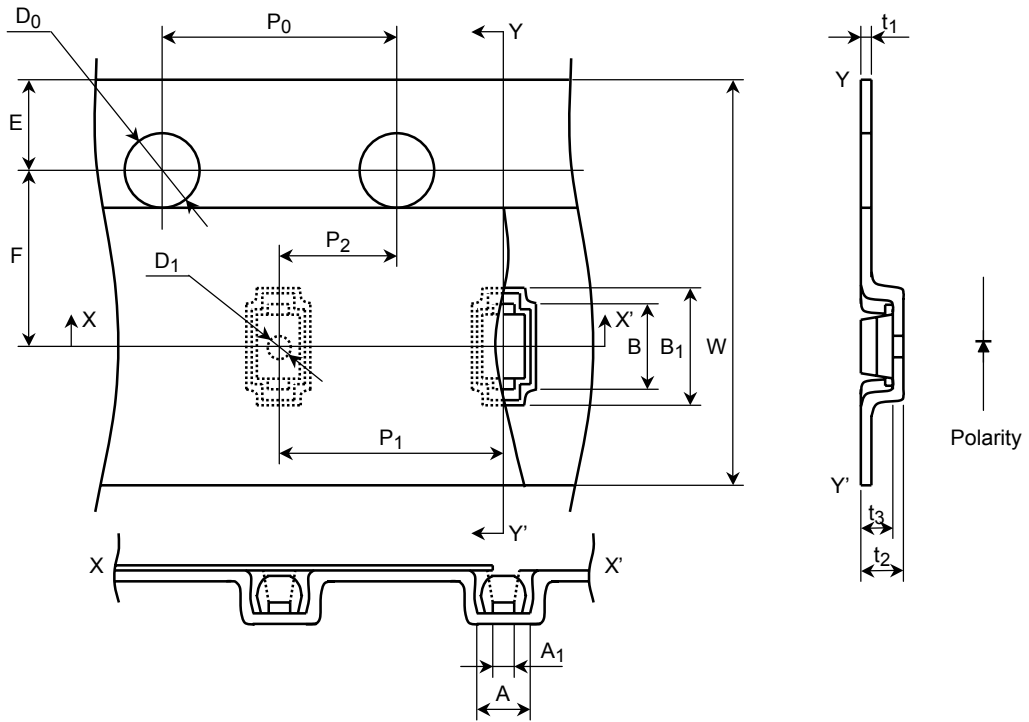

4. Reel dimensions

Unit: mm

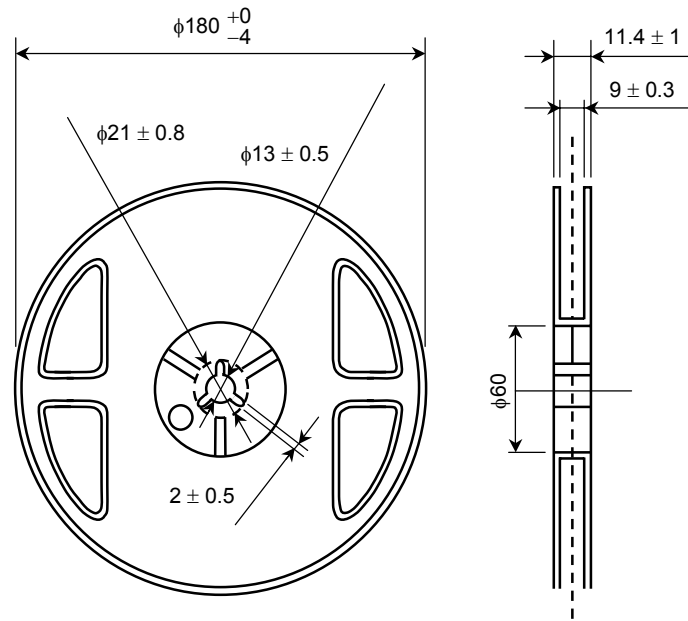

5. Leader and trailer section of tape

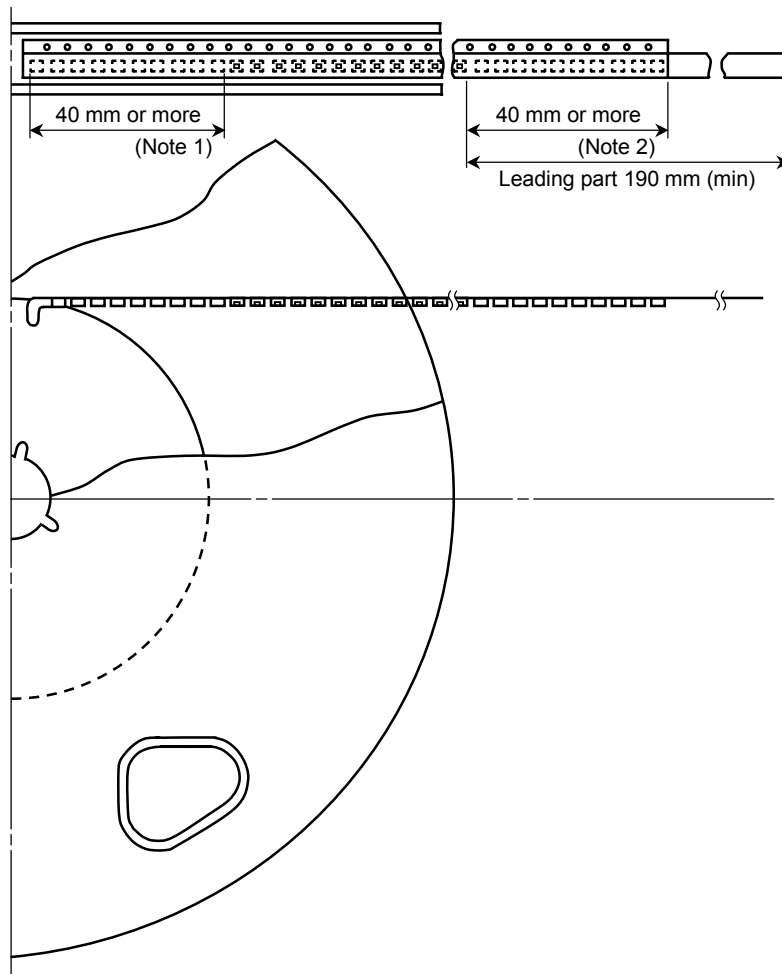

Note 1: Empty trailer section

Note 2: Empty leader section

6. Packing display

(1) Packing quantity

Reel	4,000 pcs
Carton	20,000 pcs

(2) Package form: Each reel is sealed in an aluminum pack with silica gel.

7. Label format

(1) Example: TLSV1020 (T14)

P/N:

TYPE	TLSV1020		
ADD.C	(T14)	Q'TY	4,000 pcs
NOTE (RANK SYMBOL)	Lot Number		

(2) Label location

• Reel

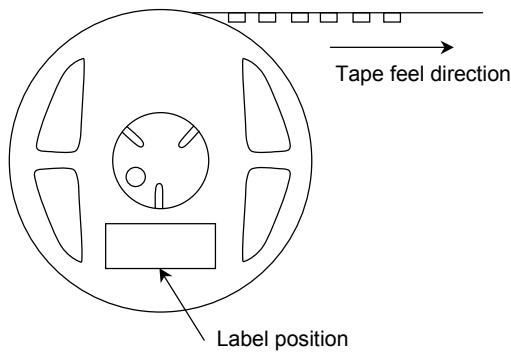

• Carton

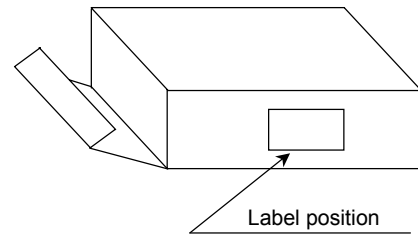

• The aluminum package in which the reel is supplied also has a copy of the label attached to center of one side.

RESTRICTIONS ON PRODUCT USE

000707EAC

- TOSHIBA is continually working to improve the quality and reliability of its products. Nevertheless, semiconductor devices in general can malfunction or fail due to their inherent electrical sensitivity and vulnerability to physical stress. It is the responsibility of the buyer, when utilizing TOSHIBA products, to comply with the standards of safety in making a safe design for the entire system, and to avoid situations in which a malfunction or failure of such TOSHIBA products could cause loss of human life, bodily injury or damage to property.
In developing your designs, please ensure that TOSHIBA products are used within specified operating ranges as set forth in the most recent TOSHIBA products specifications. Also, please keep in mind the precautions and conditions set forth in the "Handling Guide for Semiconductor Devices," or "TOSHIBA Semiconductor Reliability Handbook" etc..
- The TOSHIBA products listed in this document are intended for usage in general electronics applications (computer, personal equipment, office equipment, measuring equipment, industrial robotics, domestic appliances, etc.). These TOSHIBA products are neither intended nor warranted for usage in equipment that requires extraordinarily high quality and/or reliability or a malfunction or failure of which may cause loss of human life or bodily injury ("Unintended Usage"). Unintended Usage include atomic energy control instruments, airplane or spaceship instruments, transportation instruments, traffic signal instruments, combustion control instruments, medical instruments, all types of safety devices, etc.. Unintended Usage of TOSHIBA products listed in this document shall be made at the customer's own risk.
- Gallium arsenide (GaAs) is a substance used in the products described in this document. GaAs dust and fumes are toxic. Do not break, cut or pulverize the product, or use chemicals to dissolve them. When disposing of the products, follow the appropriate regulations. Do not dispose of the products with other industrial waste or with domestic garbage.
- The information contained herein is presented only as a guide for the applications of our products. No responsibility is assumed by TOSHIBA CORPORATION for any infringements of intellectual property or other rights of the third parties which may result from its use. No license is granted by implication or otherwise under any intellectual property or other rights of TOSHIBA CORPORATION or others.
- The information contained herein is subject to change without notice.