

TOSHIBA InGaAlP LED

TLRE50T,TLRME50T,TLSE50T,TLOE50T,LYE50T, TLPYE50T,TLGE50T,TLFGE50T,TLPGE50T

Panel Circuit Indicators

- $\phi 3$ mm package
- InGaAlP technology
- All plastic mold type
- Transparent lens
- Line-up: 6 colors (red, orange, yellow, pure yellow, green and pure green)
- High intensity light emission
- Excellent low current light output
- Applications: message boards, security devices and dashboard displays

Line-up

Product Name	Color	Material
TLRE50T	Red	InGaAlP
TLRME50T	Red	
TLSE50T	Red	
TLOE50T	Orange	
TYE50T	Yellow	
TLPYE50T	Pure Yellow	
TLGE50T	Green	
TLFGE50T	Green	
TLPGE50T	Pure Green	

Unit: mm

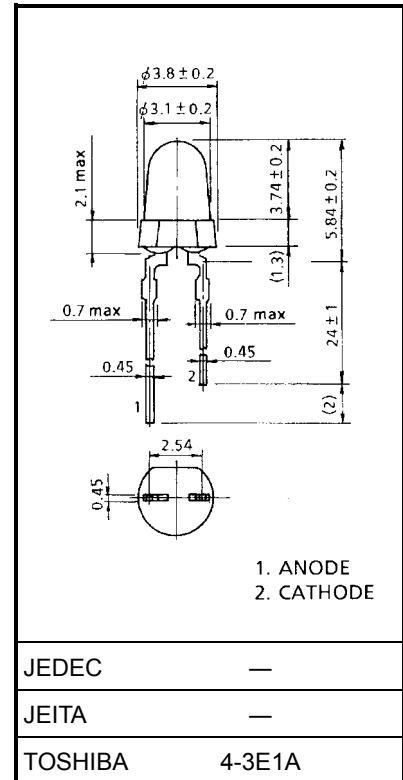

Weight: 0.14 g

Maximum Ratings (Ta = 25°C)

Product Name	Forward Current I _F (mA)	Reverse Voltage V _R (V)	Power Dissipation P _D (mW)	Operating Temperature T _{opr} (°C)	Storage Temperature T _{stg} (°C)
TLRE50T	50	4	120	-40~100	-40~120
TLRME50T	50	4	120		
TLSE50T	50	4	120		
TLOE50T	50	4	120		
TLYE50T	50	4	120		
TLPYE50T	50	4	120		
TLGE50T	50	4	120		
TLFGE50T	50	4	120		
TLPGE50T	50	4	120		

Electrical and Optical Characteristics (Ta = 25°C)

Product Name	Typ. Emission Wavelength				Luminous Intensity I _V			Forward Voltage V _F			Reverse Current I _R	
	λ _d	λ _P	Δλ	I _F	Min	Typ.	I _F	Typ.	Max	I _F	Max	V _R
TLRE50T	630	(644)	20	20	850	1800	20	1.9	2.4	20	50	4
TLRME50T	626	(636)	23	20	850	2200	20	1.9	2.4	20	50	4
TLSE50T	613	(623)	20	20	1530	3500	20	1.9	2.4	20	50	4
TLOE50T	605	(612)	20	20	1530	4500	20	2.0	2.4	20	50	4
TLYE50T	587	(590)	17	20	1530	3500	20	2.0	2.4	20	50	4
TLPYE50T	580	(583)	14	20	850	2500	20	2.0	2.4	20	50	4
TLGE50T	571	(574)	17	20	476	1500	20	2.0	2.4	20	50	4
TLFGE50T	565	(568)	15	20	272	1000	20	2.0	2.4	20	50	4
TLPGE50T	558	(562)	14	20	153	600	20	2.1	2.4	20	50	4
Unit	nm			mA	mcd		mA	V		mA	μA	V

Precautions

Please be careful of the following:

- Soldering temperature: 260°C max, soldering time: 3 s max
(soldering portion of lead: up to 2 mm from the body of the device)
- If the lead is formed, the lead should be formed up to 5 mm from the body of the device without forming stress to the resin. Soldering should be performed after lead forming.
- This visible LED lamp also emits some IR light.
If a photodetector is located near the LED lamp, please ensure that it will not be affected by this IR light.

TLRE50T

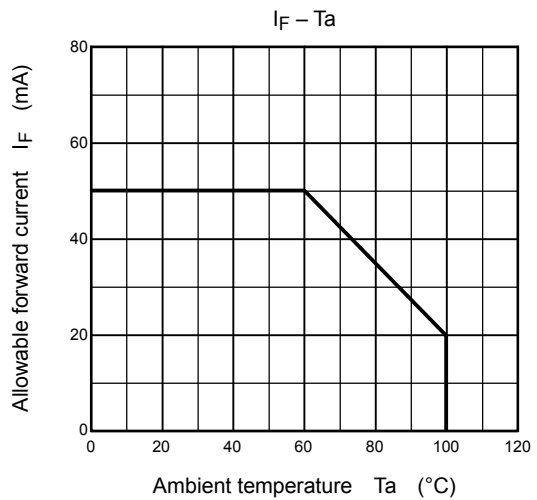
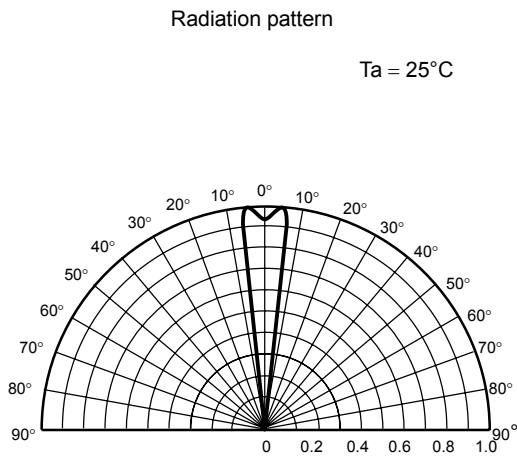
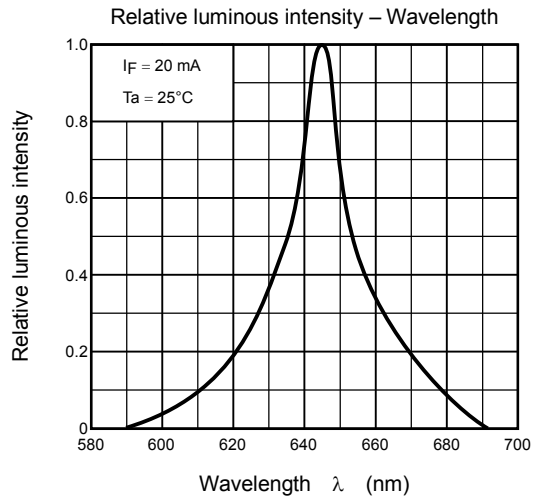
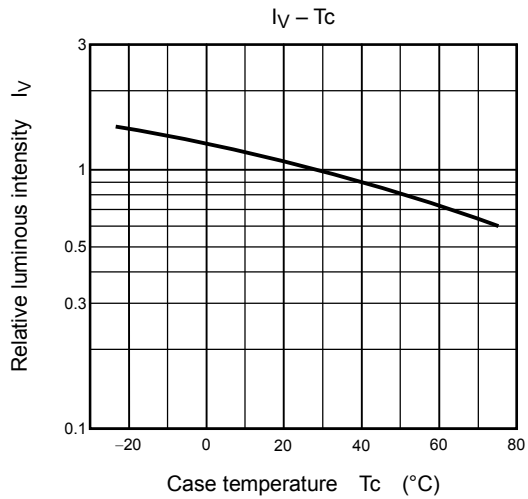
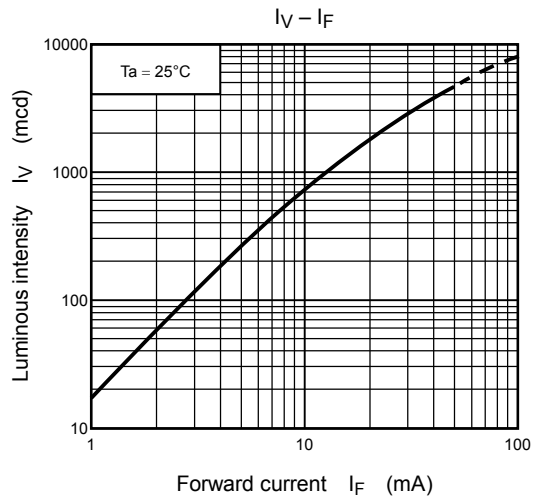
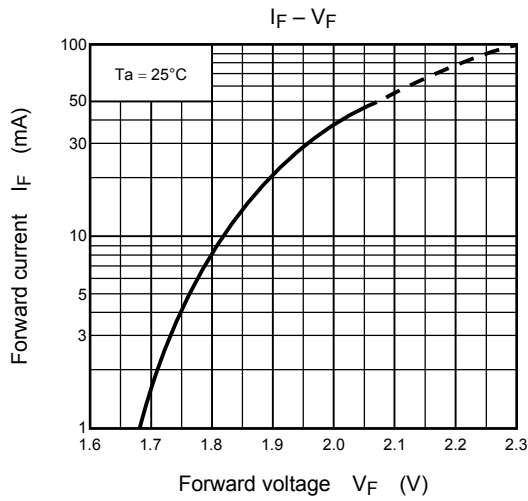

TLRME50T

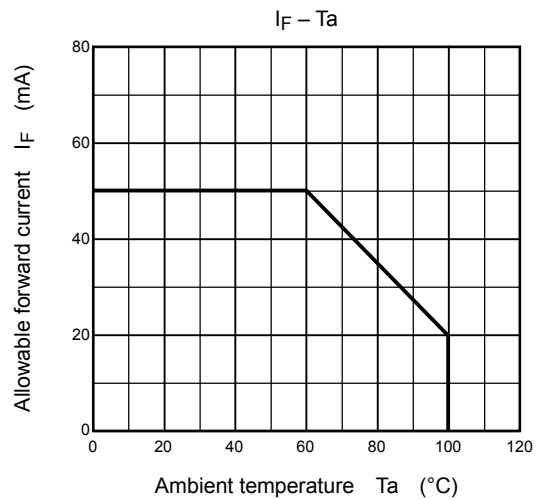
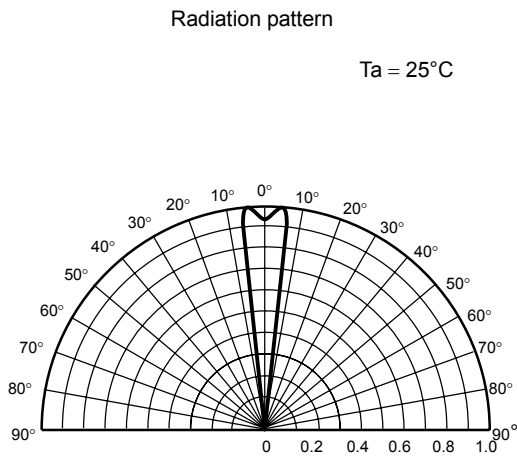
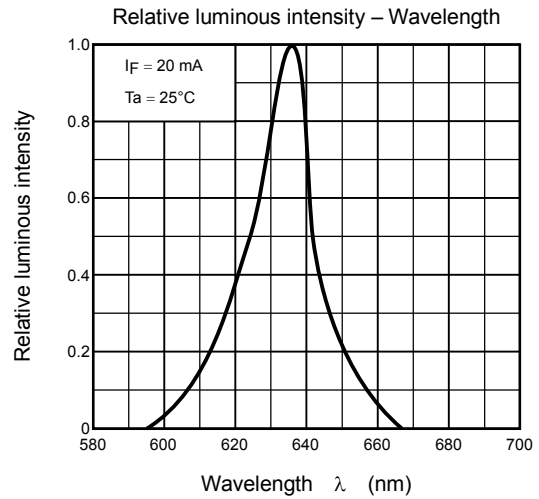
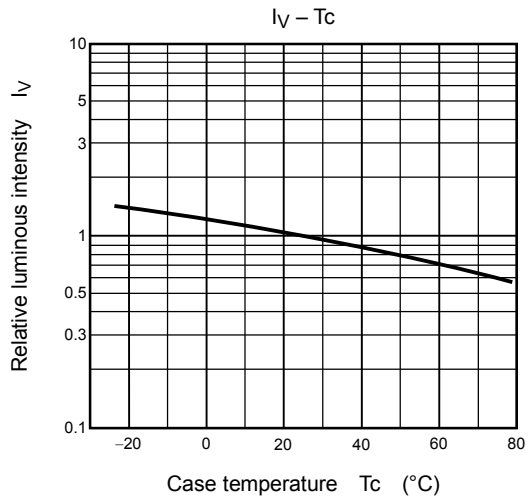
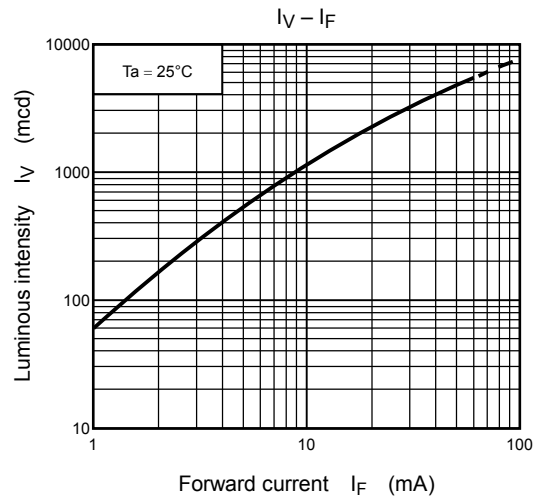
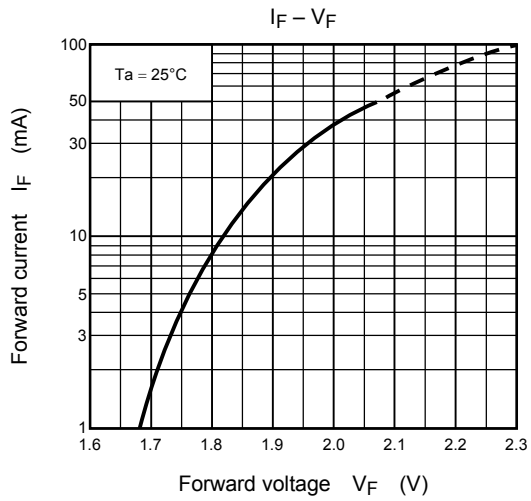

TLSE50T

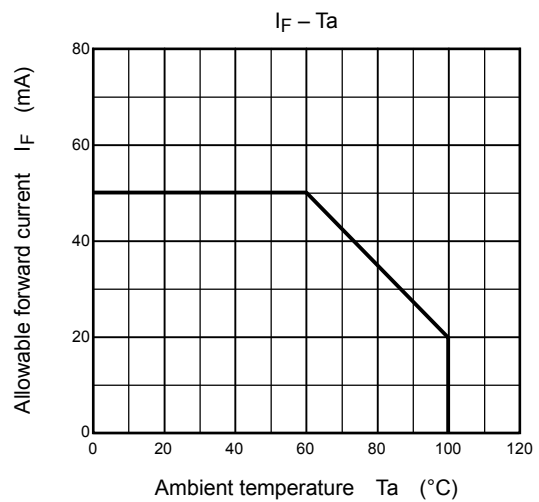
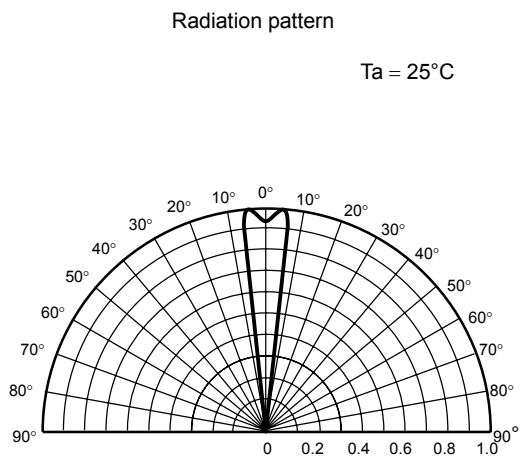
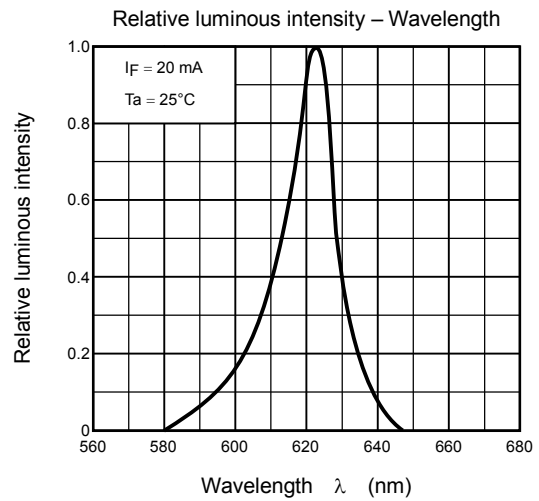
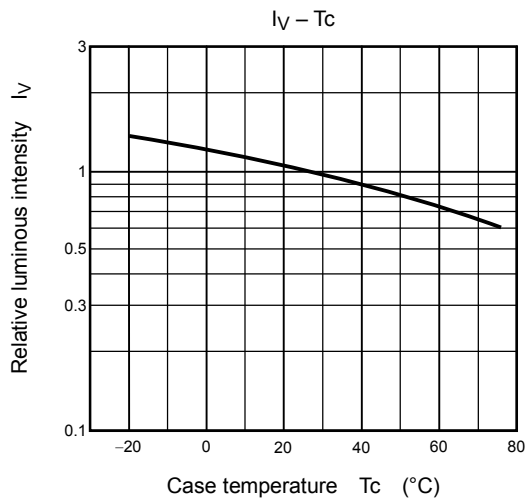
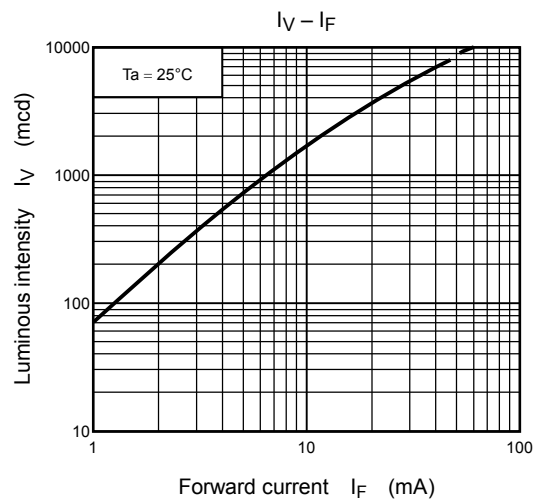
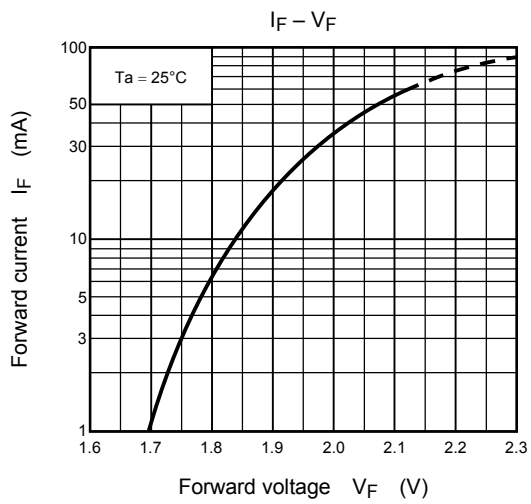

TLOE50T

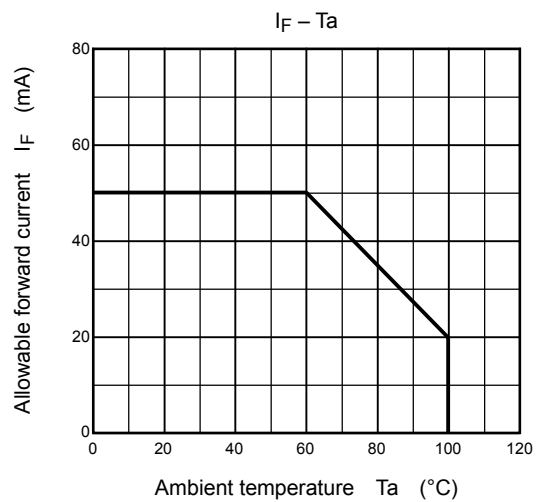
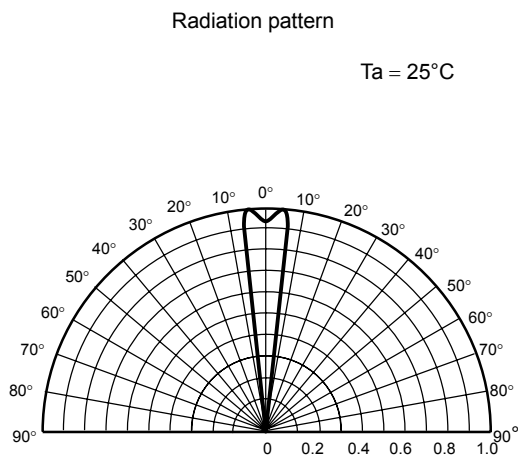
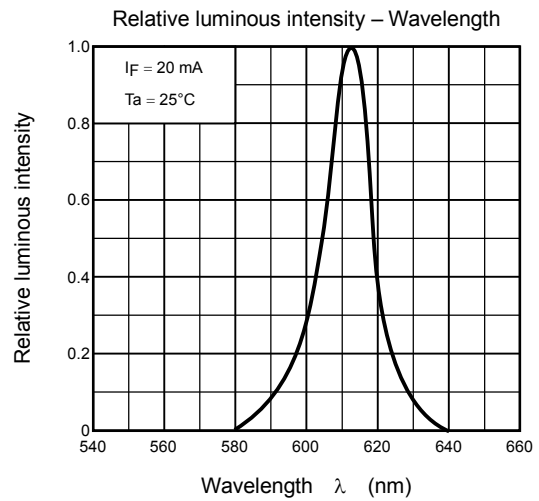
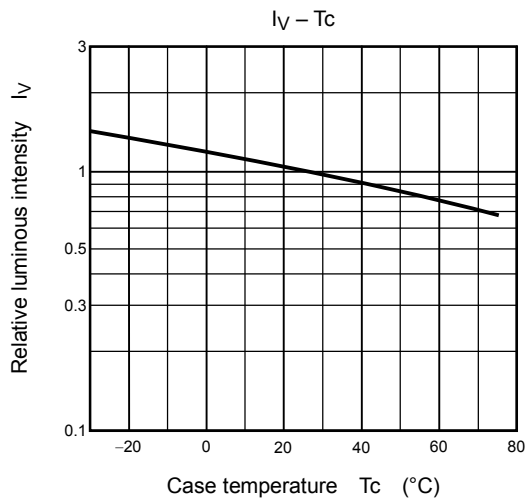
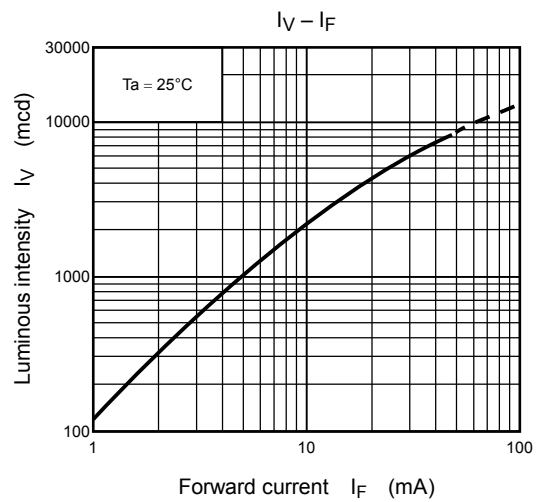
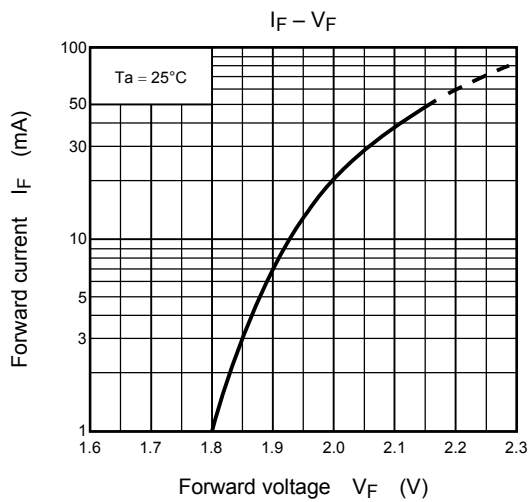

TLYE50T

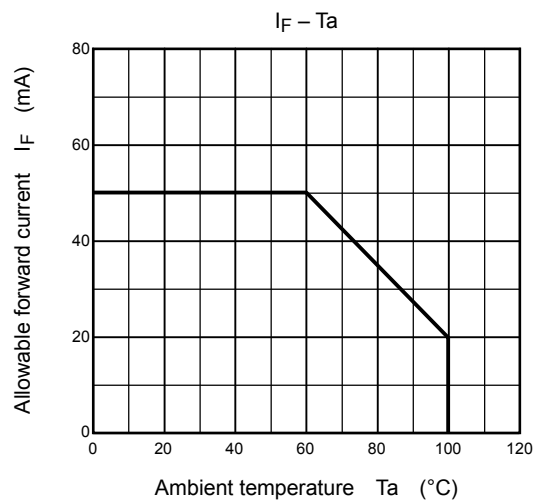
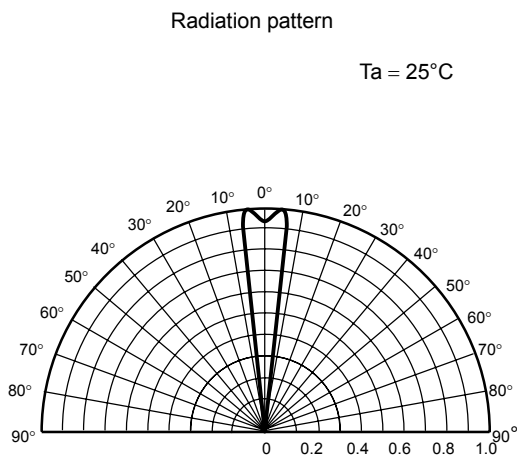
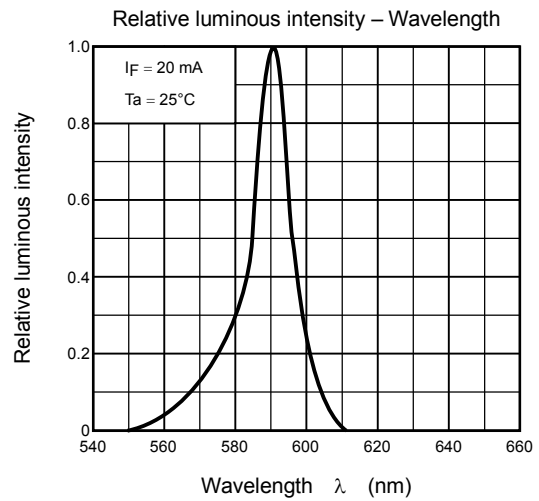
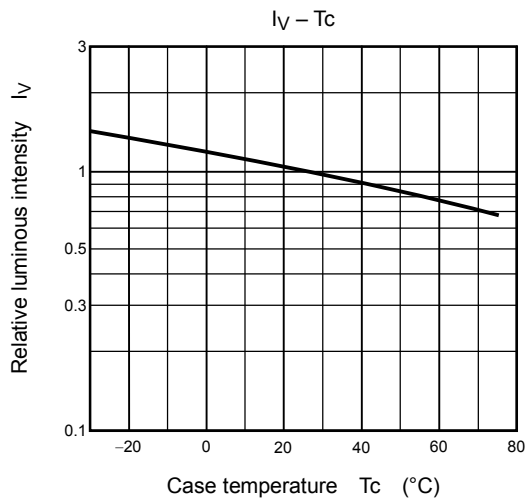
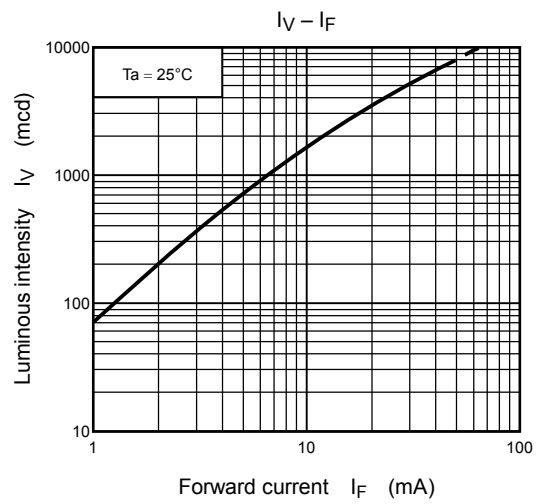
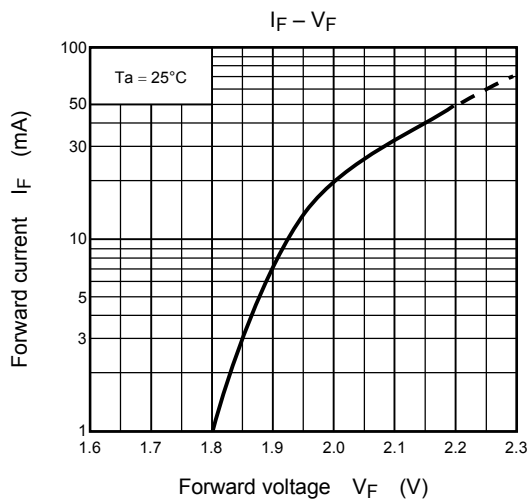

TLPYE50T

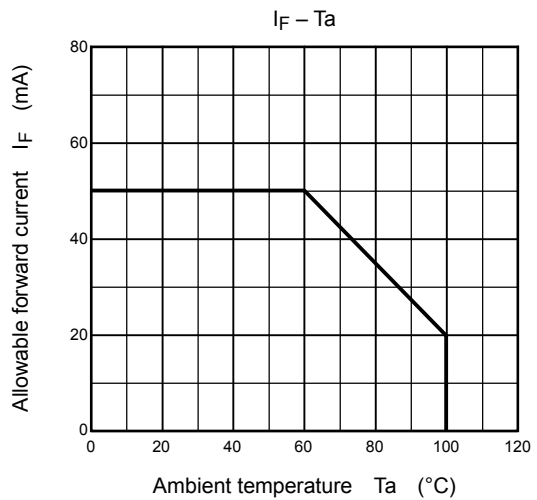
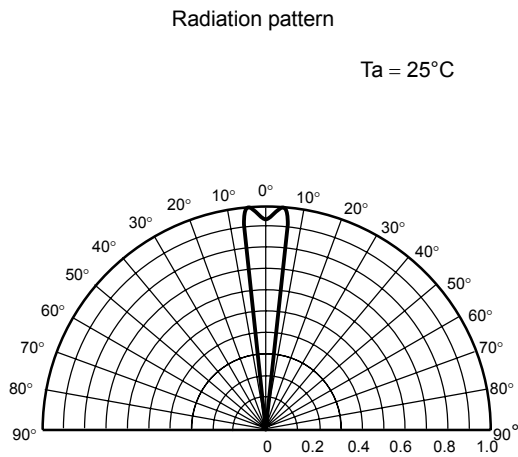
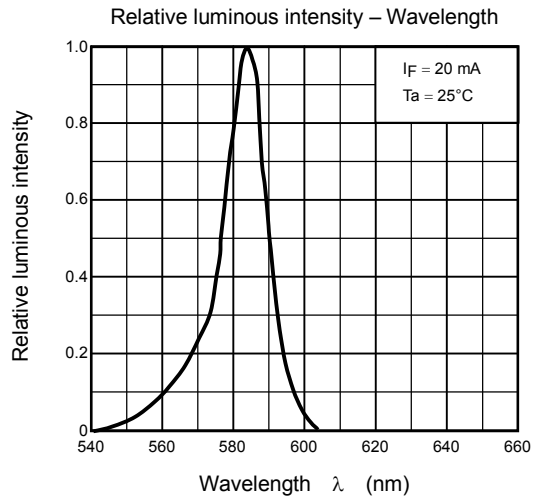
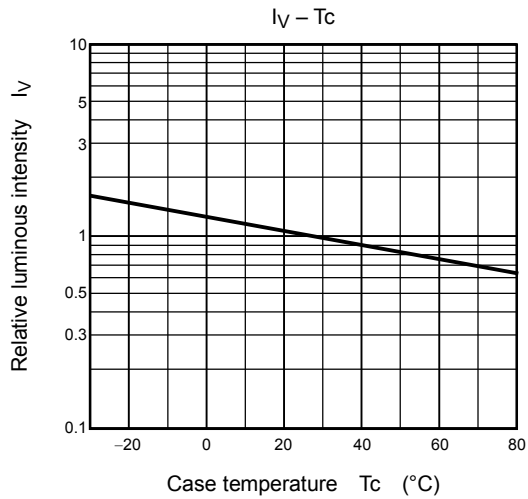
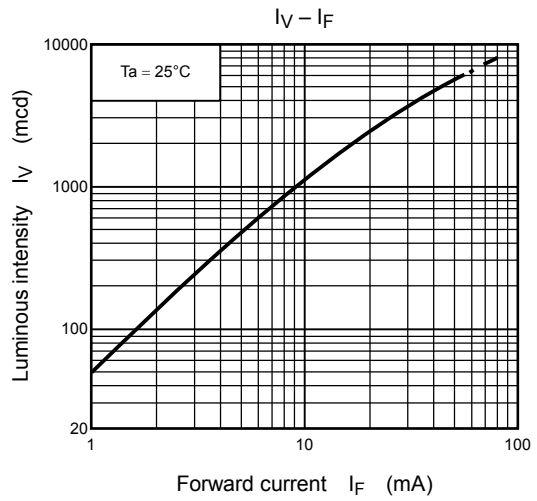
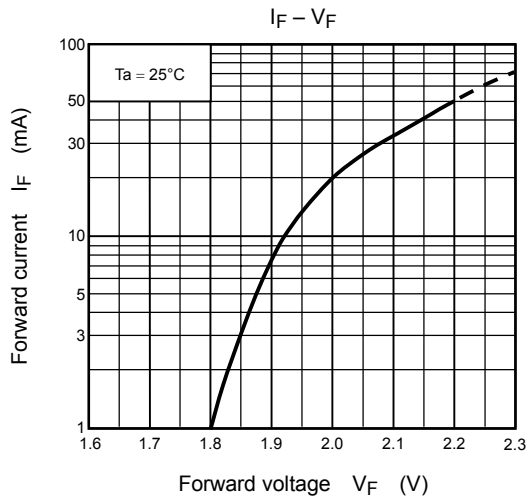

TLGE50T

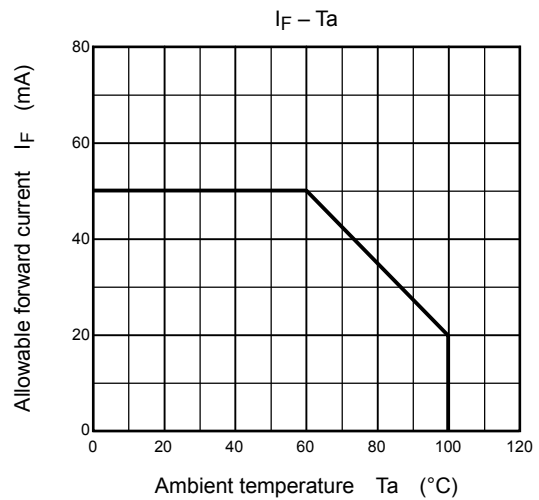
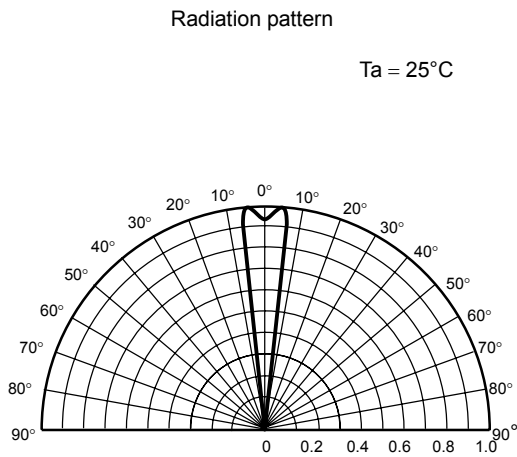
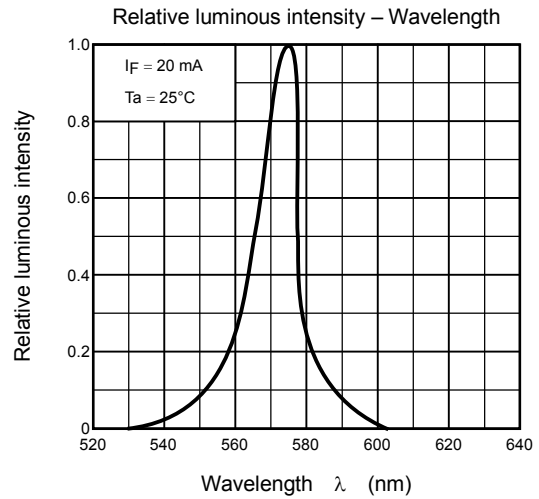
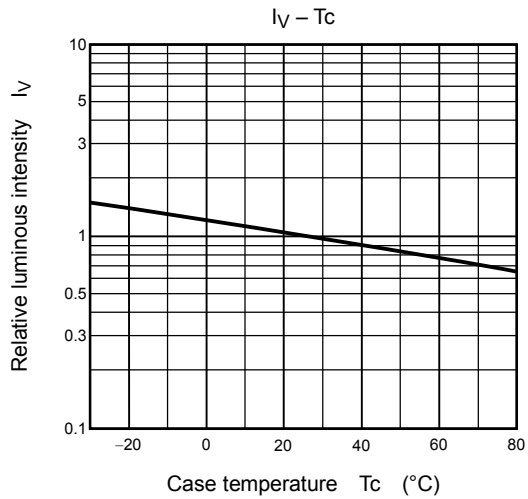
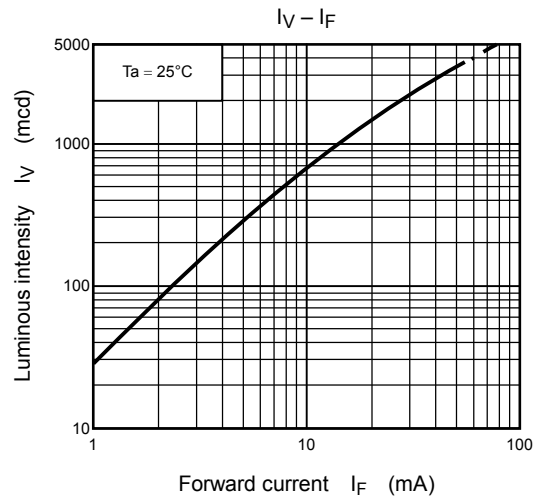
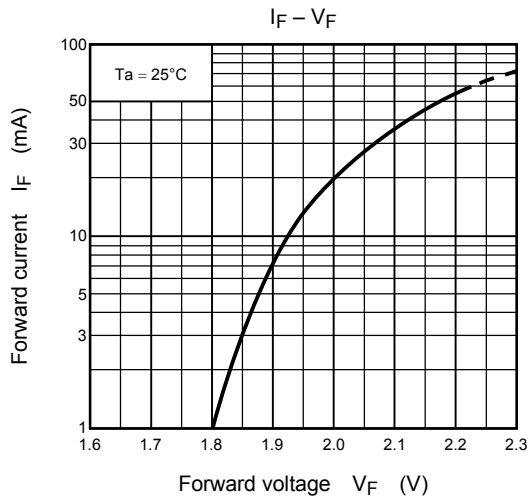

TLFGE50T

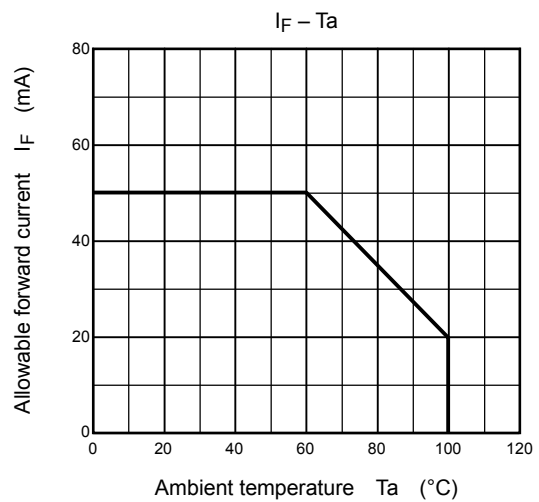
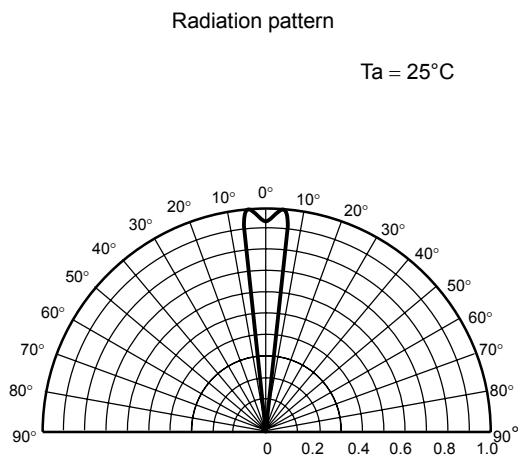
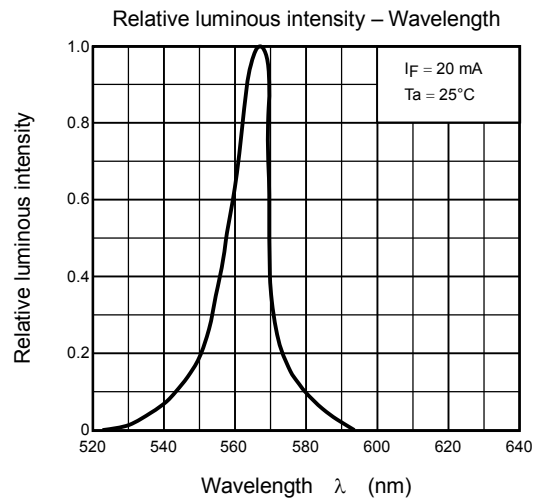
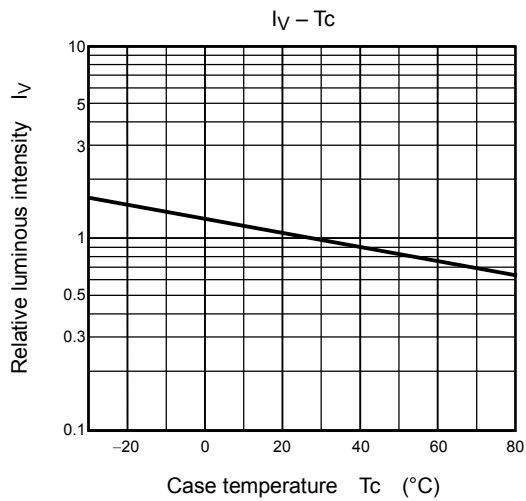
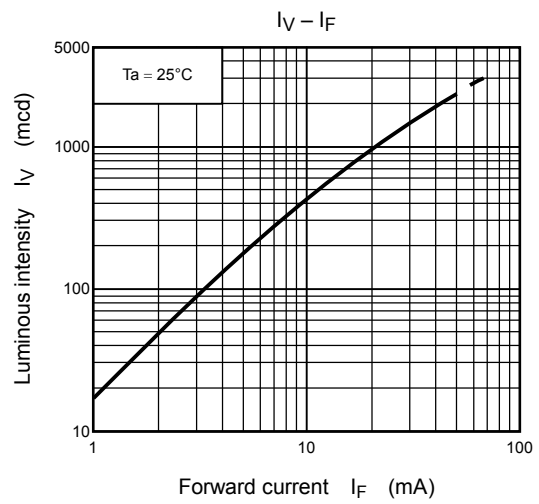
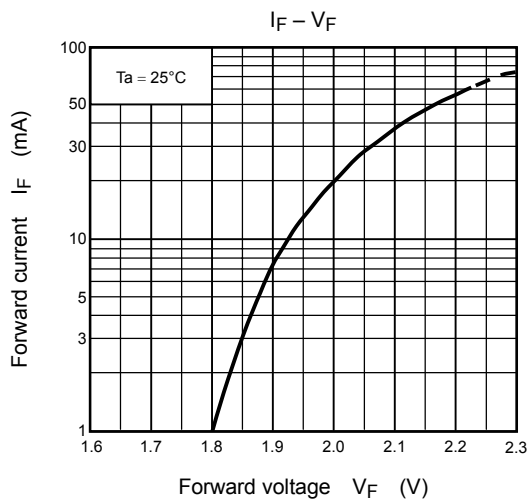

TLPGE50T

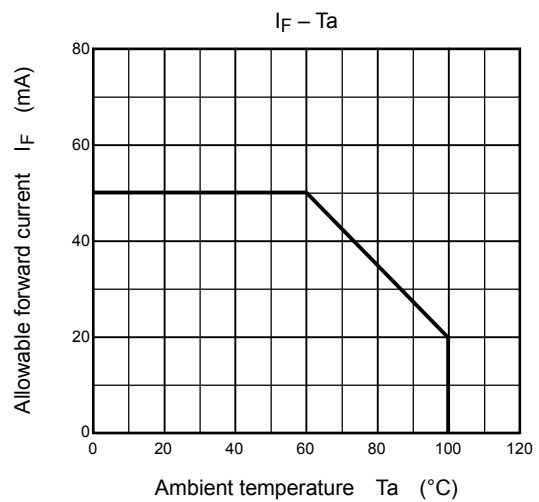
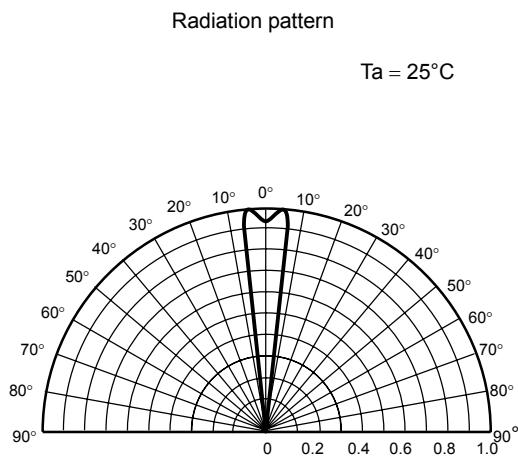
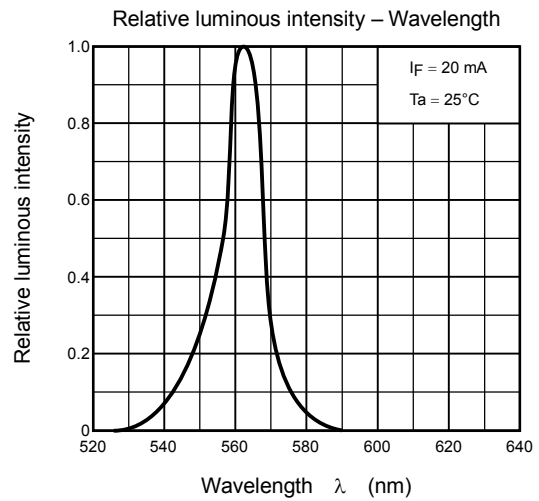
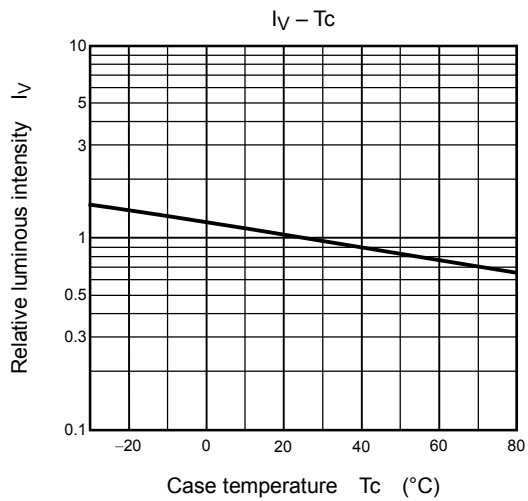
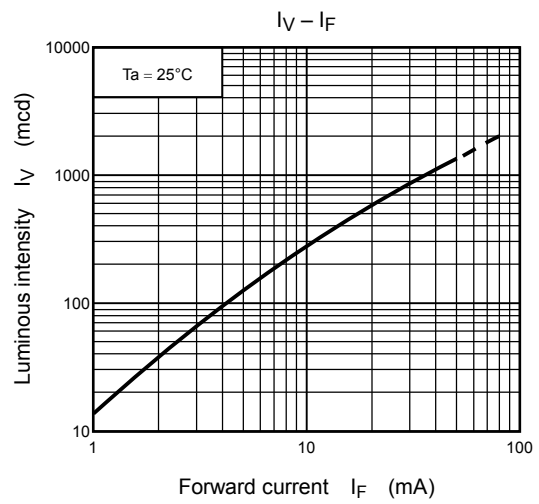
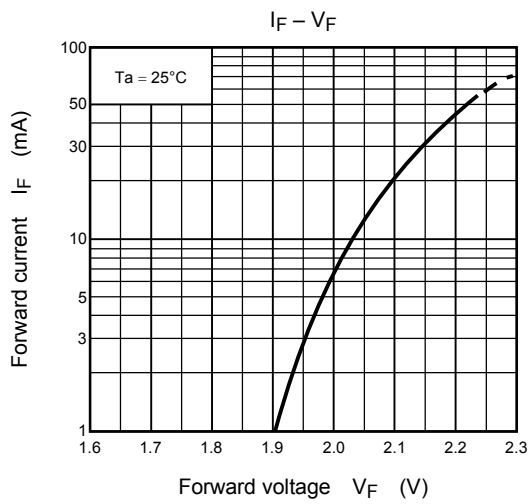

RESTRICTIONS ON PRODUCT USE

000707EAC

- TOSHIBA is continually working to improve the quality and reliability of its products. Nevertheless, semiconductor devices in general can malfunction or fail due to their inherent electrical sensitivity and vulnerability to physical stress. It is the responsibility of the buyer, when utilizing TOSHIBA products, to comply with the standards of safety in making a safe design for the entire system, and to avoid situations in which a malfunction or failure of such TOSHIBA products could cause loss of human life, bodily injury or damage to property.
In developing your designs, please ensure that TOSHIBA products are used within specified operating ranges as set forth in the most recent TOSHIBA products specifications. Also, please keep in mind the precautions and conditions set forth in the "Handling Guide for Semiconductor Devices," or "TOSHIBA Semiconductor Reliability Handbook" etc..
- The TOSHIBA products listed in this document are intended for usage in general electronics applications (computer, personal equipment, office equipment, measuring equipment, industrial robotics, domestic appliances, etc.). These TOSHIBA products are neither intended nor warranted for usage in equipment that requires extraordinarily high quality and/or reliability or a malfunction or failure of which may cause loss of human life or bodily injury ("Unintended Usage"). Unintended Usage include atomic energy control instruments, airplane or spaceship instruments, transportation instruments, traffic signal instruments, combustion control instruments, medical instruments, all types of safety devices, etc.. Unintended Usage of TOSHIBA products listed in this document shall be made at the customer's own risk.
- Gallium arsenide (GaAs) is a substance used in the products described in this document. GaAs dust and fumes are toxic. Do not break, cut or pulverize the product, or use chemicals to dissolve them. When disposing of the products, follow the appropriate regulations. Do not dispose of the products with other industrial waste or with domestic garbage.
- The information contained herein is presented only as a guide for the applications of our products. No responsibility is assumed by TOSHIBA CORPORATION for any infringements of intellectual property or other rights of the third parties which may result from its use. No license is granted by implication or otherwise under any intellectual property or other rights of TOSHIBA CORPORATION or others.
- The information contained herein is subject to change without notice.